

Digital Imaging and Communications in Medicine (DICOM)

Part 3: Information Object Definitions



Published by

National Electrical Manufacturers Association

1300 N. 17th Street

Rosslyn, Virginia 22209 USA

© Copyright 2001 by the National Electrical Manufacturers Association. All rights including translation into other languages, reserved under the Universal Copyright Convention, the Berne Convention or the Protection of Literacy and Artistic Works, and the International and Pan American Copyright Conventions.

CONTENTS

CONTENTS i

FOREWORD	xvi
1 Scope and field of application	1
2 Normative references	1
3 Definitions.....	2
3.13 CODES AND CONTROLLED TERMINOLOGY DEFINITIONS:	5
3.14 Reference Model Security Architecture Definitions	7
3.15 Security Definitions.....	8
3.16 DICOM security profiles	8
4 Symbols and abbreviations	8
5 Conventions	10
5.1 ENTITY-RELATIONSHIP MODEL.....	10
5.1.1 ENTITY.....	10
5.1.2 RELATIONSHIP	10
5.2 SEQUENCES.....	11
5.3 TRIPLET ENCODING OF STRUCTURED DATA (RETIRED).....	11
5.4 ATTRIBUTE MACROS.....	11
6 DICOM information model.....	13
6.1 INFORMATION OBJECT DEFINITION.....	13
6.1.1 COMPOSITE IOD.....	14
6.1.2 NORMALIZED IOD	14
6.2 ATTRIBUTES.....	14
6.3 ON-LINE COMMUNICATION AND MEDIA STORAGE SERVICES	14
6.3.1 DIMSE-C SERVICES.....	15
6.3.2 DIMSE-N SERVICES.....	15
6.4 DIMSE SERVICE GROUP	15
6.5 SERVICE-OBJECT PAIR (SOP) CLASS.....	15
6.5.1 NORMALIZED AND COMPOSITE SOP CLASSES.....	15
6.6 ASSOCIATION NEGOTIATION	15
6.7 SERVICE CLASS SPECIFICATION	15
7 DICOM model of the real-world.....	16
7.1 DICOM INFORMATION MODEL.....	22
7.2 ORGANIZATION OF ANNEXES A, B AND C.....	22
7.3 EXTENSION OF THE DICOM MODEL OF THE REAL-WORLD.....	22
7.3.1 Definition of the Extensions of the DICOM Real-World Model.....	23
7.3.1.1 PATIENT	23
7.3.1.2 SERVICE EPISODE	23
7.3.1.3 IMAGING SERVICE REQUEST.....	23

7.3.1.4	PROCEDURE TYPE.....	24
7.3.1.5	REQUESTED PROCEDURE	24
7.3.1.6	SCHEDULED PROCEDURE STEP	24
7.3.1.7	PROCEDURE PLAN.....	25
7.3.1.8	PROTOCOL.....	25
7.3.1.9	MODALITY PERFORMED PROCEDURE STEP.....	25
7.3.1.10	GENERAL PURPOSE SCHEDULED PROCEDURE STEP	26
7.3.1.11	GENERAL PURPOSE PERFORMED PROCEDURE STEP	26
7.3.1.12	WORKITEM.....	27
7.4	EXTENSION OF THE DICOM MODEL OF THE REAL-WORLD FOR THE GENERAL PURPOSE WORKLIST.....	27
8	Encoding of Coded Entry Data.....	29
8.1	CODE VALUE.....	30
8.2	CODING SCHEME DESIGNATOR, CODING SCHEME VERSION, AND PRIVATE CODING SCHEME CREATOR UID.....	30
8.3	CODE MEANING	32
8.4	MAPPING RESOURCE	32
8.5	CONTEXT GROUP VERSION.....	33
8.6	CONTEXT IDENTIFIER.....	33
8.7	CODE SET EXTENSIONS.....	33
8.8	STANDARD ATTRIBUTE SETS FOR CODE SEQUENCE ATTRIBUTES.....	33
9	TEMPLATE IDENTIFICATION MACRO.....	35
Annex A	Composite information object definitions (Normative).....	37
A.1	ELEMENTS OF AN INFORMATION OBJECT DEFINITION.....	37
A.1.1	IOD Description.....	37
A.1.2	IOD Entity-Relationship Model.....	37
A.1.2.1	PATIENT IE	38
A.1.2.2	STUDY IE	38
A.1.2.3	SERIES IE.....	39
A.1.2.4	EQUIPMENT IE.....	39
A.1.2.5	FRAME OF REFERENCE IE.....	39
A.1.2.6	IMAGE IE	39
A.1.2.7	OVERLAY IE	40
A.1.2.8	CURVE IE	40
A.1.2.9	MODALITY LUT IE.....	40
A.1.2.10	VOI LUT IE	40
A.1.2.11	PRESENTATION STATE IE.....	41
A.1.2.12	WAVEFORM IE	41
A.1.2.13	SR DOCUMENT IE	41
A.1.3	IOD Module Table.....	41
A.1.3.1	MANDATORY MODULES.....	41
A.1.3.2	CONDITIONAL MODULES	41
A.1.3.3	USER OPTION MODULES.....	42
A.1.4	Overview of the Composite IOD Module Content	42
A.2	COMPUTED RADIOGRAPHY IMAGE INFORMATION OBJECT DEFINITION.....	54
A.2.1	CR Image IOD Description.....	54
A.2.2	CR Image IOD Entity-Relationship Model.....	54
A.2.3	CR Image IOD Module Table.....	54

A.3	COMPUTED TOMOGRAPHY IMAGE INFORMATION OBJECT DEFINITION.....	54
A.3.1	CT Image IOD Description	54
A.3.2	CT image IOD Entity-Relationship Model	54
A.3.3	CT Image IOD Module Table	55
A.4	MAGNETIC RESONANCE IMAGE INFORMATION OBJECT DEFINITION.....	55
A.4.1	MR Image IOD Description	55
A.4.2	MR image IOD Entity-Relationship Model	55
A.4.3	MR Image IOD Module Table	56
A.5	NUCLEAR MEDICINE IMAGE INFORMATION OBJECT DEFINITION	56
A.5.1	NM Image IOD Description	56
A.5.2	NM Image IOD Entity-Relationship Model	56
A.5.3	NM Image IOD Module Table (Retired).....	56
A.5.4	NM Image IOD Module Table	57
A.6	ULTRASOUND IMAGE INFORMATION OBJECT DEFINITION	58
A.6.1	US Image IOD Description.....	58
A.6.2	US Image IOD Entity-Relationship Model.....	58
A.6.3	US Image IOD Module Table (Retired)	58
A.6.4	US Image IOD Module Table.....	59
A.6.4.1	Mutually Exclusive IEs.....	59
A.7	ULTRASOUND MULTI-FRAME IMAGE INFORMATION OBJECT DEFINITION.....	60
A.7.1	US Image IOD Description.....	60
A.7.2	US Multi-Frame Image IOD Entity-Relationship Model.....	60
A.7.3	US Image IOD Module Table (Retired)	60
A.7.4	US Multi-Frame Image IOD Module Table	61
A.7.4.1	MUTUALLY EXCLUSIVE IES.....	62
A.8	SECONDARY CAPTURE IMAGE INFORMATION OBJECT DEFINITION	62
A.8.1	SC Image Information Objection Definition.....	62
A.8.1.1	SC Image IOD Description.....	62
A.8.1.2	SC Image IOD Entity-Relationship Model.....	63
A.8.1.3	SC Image IOD Module Table.....	63
A.8.2	Multi-frame Single Bit SC Image Information Object Definition.....	63
A.8.2.1	Multi-frame Single Bit SC Image IOD Description.....	63
A.8.2.2	Multi-frame Single Bit SC Image IOD Entity-Relationship Model.....	63
A.8.2.3	SC Image IOD Module Table.....	64
A.8.2.4	Multi-frame Single Bit SC Image IOD Content Constraints	64
A.8.3	Multi-frame Grayscale Byte SC Image Information Object Definition	65
A.8.3.1	Multi-frame Grayscale Byte Image IOD Description.....	65
A.8.3.2	Multi-frame Grayscale Byte SC Image IOD Entity-Relationship Model	65
A.8.3.3	Multi-frame Grayscale Byte SC Image IOD Module Table	65
A.8.3.4	Multi-frame Grayscale Byte SC Image IOD Content Constraints.....	65
A.8.4	Multi-frame Grayscale Word SC Image Information Object Definition	66
A.8.4.1	Multi-frame Grayscale Word SC Image IOD Description	66
A.8.4.2	Multi-frame Grayscale Word SC Image IOD Entity-Relationship Model	66
A.8.4.3	Multi-frame Grayscale Word SC Image IOD Module Table	67
A.8.4.4	Multi-frame Grayscale Word SC Image IOD Content Constraints.....	67
A.8.5	Multi-frame True Color SC Image Information Object Definition	68
A.8.5.1	Multi-frame True Color Image IOD Description	68
A.8.5.2	Multi-frame True Color SC Image IOD Entity-Relationship Model	68
A.8.5.3	Multi-frame True Color SC Image IOD Module Table.....	68
A.8.5.4	Multi-frame True Color SC Image IOD Content Constraints	68
A.9	STANDALONE OVERLAY INFORMATION OBJECT DEFINITION	69

A.9.1	Standalone Overlay IOD Description.....	69
A.9.2	Standalone Overlay IOD Entity-Relationship Model.....	69
A.9.3	Standalone Overlay IOD Module Table.....	69
A.10	STANDALONE CURVE INFORMATION OBJECT DEFINITION.....	70
A.10.1	Standalone Curve IOD Description.....	70
A.10.2	Standalone Curve IOD Entity-Relationship Model.....	70
A.10.3	Standalone Curve IOD Module Table.....	70
A.11	BASIC STUDY DESCRIPTOR INFORMATION OBJECT DEFINITION	71
A.11.1	Basic Study Descriptor IOD Description	71
A.11.2	Basic Study Descriptor Entity-Relationship Model	71
A.11.3	Basic Study Descriptor IOD Module Table	71
A.12	STANDALONE MODALITY LUT INFORMATION OBJECT DEFINITION.....	72
A.12.1	Standalone Modality LUT IOD Description.....	72
A.12.2	Standalone Modality LUT IOD Entity-Relationship Model.....	72
A.12.3	Standalone Modality LUT IOD Module Table.....	72
A.13	STANDALONE VOI LUT INFORMATION OBJECT DEFINITION.....	72
A.13.1	Standalone VOI LUT IOD Description	72
A.13.2	Standalone VOI LUT IOD Entity-Relationship Model.....	72
A.13.3	Standalone VOI LUT IOD Module Table	73
A.14	X-RAY ANGIOGRAPHIC IMAGE INFORMATION OBJECT DEFINITION.....	74
A.14.1	XA Image IOD Description	74
A.14.2	XA Image IOD Entity-Relationship Model	74
A.14.3	XA Image IOD Module Table	75
A.15	X-RAY ANGIOGRAPHIC BI-PLANE IMAGE INFORMATION OBJECT DEFINITION (RETIRED).....	76
A.16	X-RAY RF IMAGE INFORMATION OBJECT DEFINITION.....	76
A.16.1	XRF Image IOD Description	76
A.16.2	XRF Image IOD Entity-Relationship Model	76
A.16.3	XRF Image IOD Module Table.....	76
A.17	RT IMAGE INFORMATION OBJECT DEFINITION	78
A.17.1	RT Image IOD Description	78
A.17.2	RT Image IOD entity-relationship model.....	78
A.17.3	RT Image IOD Module Table.....	79
A.18	RT DOSE INFORMATION OBJECT DEFINITION	81
A.18.1	RT Dose IOD Description	81
A.18.2	RT Dose IOD entity-relationship model	81
A.18.3	RT Dose IOD Module Table	82
A.19	RT STRUCTURE SET INFORMATION OBJECT DEFINITION	83
A.19.1	RT Structure Set IOD Description.....	83
A.19.2	RT Structure Set IOD entity-relationship model.....	83
A.19.3	RT Structure Set IOD Module Table.....	84
A.20	RT PLAN INFORMATION OBJECT DEFINITION	85
A.20.1	RT Plan IOD Description	85
A.20.2	RT Plan IOD entity-relationship model	85
A.20.3	RT Plan IOD Module Table	86
A.20.3.1	RT FRACTION SCHEME MODULE	86
A.20.3.2	RT PRESCRIPTION MODULE	86
A.20.3.3	RT TOLERANCE TABLES MODULE	87
A.20.3.4	RT PATIENT SETUP MODULE	87
A.21	POSITRON EMISSION TOMOGRAPHY IMAGE INFORMATION OBJECT DEFINITION.....	88

A.21.1	PET Image IOD Description.....	88
A.21.2	PET Image IOD Entity-Relationship Model.....	88
A.21.3	PET Image IOD Module Table.....	88
A.22	STANDALONE PET CURVE INFORMATION OBJECT DEFINITION	89
A.22.1	Standalone PET Curve IOD Description	89
A.22.2	Standalone PET Curve IOD Entity-Relationship Model.....	89
A.22.3	Standalone PET Curve IOD Module Table	89
A.23	STORED PRINT INFORMATION OBJECT DEFINITION.....	89
A.23.1	IOD Description.....	89
A.23.2	Stored Print IOD Entity-Relationship Model.....	89
A.23.3	IOD Module Table.....	90
A.24	HARDCOPY GRAYSCALE IMAGE INFORMATION OBJECT DEFINITION.....	90
A.24.1	IOD Description.....	90
A.24.2	Hardcopy Grayscale Image IOD Entity-Relationship Model.....	90
A.24.3	IOD Module Table.....	91
A.25	HARDCOPY COLOR IMAGE INFORMATION OBJECT DEFINITION.....	91
A.25.1	IOD Description.....	91
A.25.2	Hardcopy Color Image IOD Entity-Relationship Model.....	91
A.25.3	IOD Module Table.....	91
A.26	DIGITAL X-RAY IMAGE INFORMATION OBJECT DEFINITION.....	92
A.26.1	DX Image IOD Description	92
A.26.2	DX Image IOD Entity-Relationship Model	92
A.26.3	DX Image IOD Module Table	92
A.26.4	Overlay Plane Module	94
A.27	DIGITAL MAMMOGRAPHY X-RAY IMAGE INFORMATION OBJECT DEFINITION.....	94
A.27.1	Digital Mammography X-Ray Image IOD Description	94
A.27.2	Digital Mammography X-Ray Image IOD Module Table	94
A.27.3	Overlay Plane Module	96
A.28	DIGITAL INTRA-ORAL X-RAY IMAGE INFORMATION OBJECT DEFINITION.....	96
A.28.1	Digital Intra-oral X-Ray Image IOD Description	96
A.28.2	Digital Intra-oral X-Ray Image IOD Module Table	97
A.28.3	Overlay Plane Module	98
A.29	RT BEAMS TREATMENT RECORD INFORMATION OBJECT DEFINITION.....	98
A.29.1	RT Beams Treatment Record IOD Description.....	98
A.29.2	RT Beams Treatment Record IOD entity-relationship model.....	98
A.29.3	RT Beams Treatment Record IOD Module Table.....	100
A.30	RT BRACHY TREATMENT RECORD INFORMATION OBJECT DEFINITION	100
A.30.1	RT Brachy Treatment Record IOD Description.....	100
A.30.2	RT Brachy Treatment Record IOD entity-relationship model.....	100
A.30.3	RT Brachy Treatment Record IOD Module Table.....	102
A.31	RT TREATMENT SUMMARY RECORD INFORMATION OBJECT DEFINITION.....	102
A.31.1	RT Treatment Summary Record IOD Description	102
A.31.2	RT Treatment Summary Record IOD entity-relationship model.....	102
A.31.3	RT Treatment Summary Record IOD Module Table	103
A.32	VISIBLE LIGHT IMAGE INFORMATION OBJECT DEFINITIONS.....	103
A.32.1	VL Endoscopic Image Information Object Definition	103
A.32.1.1	VL Endoscopic Image IOD Description	103
A.32.1.2	VL Endoscopic Image IOD Entity-Relationship Model	104
A.32.1.3	VL Endoscopic Image IOD Content Constraints.....	104

A.32.2	VL Microscopic Image Information Object Definition	105
A.32.2.1	VL Microscopic Image IOD Description	105
A.32.2.2	VL Microscopic Image IOD Entity-Relationship Model	105
A.32.2.3	VL Microscopic Image IOD Content Constraints	105
A.32.3	VL Slide-Coordinates Microscopic Image Information Object Definition	106
A.32.3.1	VL Slide-Coordinates Microscopic Image IOD Description	106
A.32.3.2	VL Slide-Coordinates Microscopic Image IOD Entity-Relationship Model	106
A.32.3.3	VL Slide-Coordinates Microscopic Image IOD Content Constraints	107
A.32.4	VL Photographic Image Information Object Definition	107
A.32.4.1	VL Photographic Image IOD Description	107
A.32.4.2	VL Photographic Image IOD Entity-Relationship Model	107
A.32.4.3	VL Photographic Image IOD Content Constraints	108
A.33	GRAYSCALE SOFTCOPY PRESENTATION STATE INFORMATION OBJECT DEFINITION	109
A.33.1	Grayscale Softcopy Presentation State IOD Description	109
A.33.2	Grayscale Softcopy Presentation State IOD Module Table	110
A.34	WAVEFORM INFORMATION OBJECT DEFINITIONS	112
A.34.1	Waveform IOD Entity-Relationship Model	112
A.34.2	Basic Voice Audio Information Object Definition	112
A.34.2.1	Basic Voice Audio IOD Description	112
A.34.2.2	Basic Voice Audio IOD Entity-Relationship Model	112
A.34.2.3	Basic Voice Audio IOD Module Table	112
A.34.2.4	Basic Voice Audio IOD Content Constraints	113
A.34.3	12-Lead Electrocardiogram Information Object Definition	113
A.34.3.1	12-Lead ECG IOD Description	113
A.34.3.2	12-Lead ECG IOD Entity-Relationship Model	113
A.34.3.3	12-Lead ECG IOD Module Table	113
A.34.3.4	12-Lead ECG IOD Content Constraints	114
A.34.4	General Electrocardiogram Information Object Definition	116
A.34.4.1	General ECG IOD Description	116
A.34.4.2	General ECG IOD Entity-Relationship Model	116
A.34.4.3	General ECG IOD Module Table	116
A.34.4.4	General ECG IOD Content Constraints	116
A.34.5	Ambulatory Electrocardiogram Information Object Definition	117
A.34.5.1	Ambulatory ECG IOD Description	117
A.34.5.2	Ambulatory ECG IOD Entity-Relationship Model	117
A.34.5.3	Ambulatory ECG IOD Module Table	117
A.34.5.4	Ambulatory ECG IOD Content Constraints	118
A.34.6	Hemodynamic Information Object Definition	118
A.34.6.1	Hemodynamic IOD Description	118
A.34.6.2	Hemodynamic IOD Entity-Relationship Model	118
A.34.6.3	Hemodynamic IOD Module Table	118
A.34.6.4	Hemodynamic IOD Content Constraints	119
A.34.7	Basic Cardiac Electrophysiology Information Object Definition	120
A.34.7.1	Basic Cardiac EP IOD Description	120
A.34.7.2	Basic Cardiac EP IOD Entity-Relationship Model	120
A.34.7.3	Basic Cardiac EP IOD Module Table	120
A.34.7.4	Basic Cardiac EP IOD Content Constraints	120
A.35	STRUCTURED REPORT DOCUMENT INFORMATION OBJECT DEFINITIONS	122
A.35.1	Basic Text SR Information Object Definition	122
A.35.1.1	Basic Text SR Information Object Description	122
A.35.1.2	Basic Text SR IOD Entity-Relationship Model	122
A.35.1.3	Basic Text SR IOD Module Table	122

A.35.2	Enhanced SR Information Object Definition.....	123
A.35.2.1	Enhanced SR Information Object Description.....	123
A.35.2.2	Enhanced SR IOD Entity-Relationship Model.....	124
A.35.2.3	Enhanced SR IOD Module Table.....	124
A.35.3	Comprehensive SR Information Object Definition.....	125
A.35.3.1	Comprehensive SR Information Object Description.....	125
A.35.3.2	Comprehensive SR IOD Entity-Relationship Model.....	126
A.35.3.3	Comprehensive SR IOD Module Table.....	126
A.35.4	Key Object Selection Document Information Object Definition.....	128
A.35.4.1	Key Object Selection Document Information Object Description.....	128
A.35.4.2	Key Object Selection Document IOD Entity-Relationship Model.....	128
A.35.4.3	Key Object Selection Document IOD Module Table.....	128
A.35.5	Mammography CAD SR Information Object Definition.....	129
A.35.5.1	Mammography CAD SR Information Object Description.....	129
A.35.5.2	Mammography CAD SR IOD Entity-Relationship Model.....	129
A.35.5.3	Mammography CAD SR IOD Module Table.....	129
Annex B	Normalized Information Object Definitions (Normative).....	132
B.1	PATIENT INFORMATION OBJECT DEFINITION.....	132
B.1.1	IOD description.....	132
B.1.2	Patient IOD modules.....	132
B.2	VISIT INFORMATION OBJECT DEFINITION.....	132
B.2.1	IOD description.....	132
B.2.2	IOD modules.....	133
B.3	STUDY INFORMATION OBJECT DEFINITION.....	133
B.3.1	IOD description.....	133
B.3.2	IOD modules.....	134
B.4	STUDY COMPONENT INFORMATION OBJECT DEFINITION.....	134
B.4.1	IOD description.....	134
B.4.2	IOD modules.....	134
B.5	RESULTS INFORMATION OBJECT DEFINITION.....	134
B.5.1	IOD description.....	134
B.5.2	IOD modules.....	135
B.6	INTERPRETATION INFORMATION OBJECT DEFINITION.....	135
B.6.1	IOD description.....	135
B.6.2	IOD modules.....	136
B.7	BASIC FILM SESSION INFORMATION OBJECT DEFINITION.....	136
B.7.1	IOD description.....	136
B.7.2	IOD modules.....	136
B.8	BASIC FILM BOX INFORMATION OBJECT DEFINITION.....	137
B.8.1	IOD description.....	137
B.8.2	IOD modules.....	137
B.9	BASIC IMAGE BOX INFORMATION OBJECT DEFINITION.....	137
B.9.1	IOD description.....	137
B.9.2	IOD modules.....	137
B.10	BASIC ANNOTATION INFORMATION OBJECT DEFINITION.....	138
B.10.1	IOD description.....	138
B.10.2	IOD modules.....	138
B.11	PRINT JOB INFORMATION OBJECT DEFINITION.....	138
B.11.1	IOD description.....	138

B.11.2	IOD modules	138
B.12	PRINTER INFORMATION OBJECT DEFINITION.....	138
B.12.1	IOD description	138
B.12.2	IOD modules	138
B.13	VOI LUT BOX INFORMATION OBJECT DEFINITION (RETIRED).....	138
B.14	IMAGE OVERLAY BOX INFORMATION OBJECT DEFINITION (RETIRED)	139
B.15	STORAGE COMMITMENT INFORMATION OBJECT DEFINITION	139
B.15.1	Storage Commitment IOD Description	139
B.15.2	Storage Commitment IOD Modules	139
B.16	PRINT QUEUE INFORMATION OBJECT DEFINITION.....	139
B.16.1	IOD Description.....	139
B.16.2	IOD Modules	139
B.17	MODALITY PERFORMED PROCEDURE STEP INFORMATION OBJECT DEFINITION.....	140
B.17.1	IOD Description.....	140
B.17.2	IOD Modules	140
B.18	PRESENTATION LUT INFORMATION OBJECT DEFINITION	140
B.18.1	IOD Description.....	140
B.18.2	IOD Modules	141
B.19	PULL PRINT REQUEST INFORMATION OBJECT DEFINITION.....	141
B.19.1	IOD description	141
B.19.2	IOD module table.....	141
B.20	PRINTER CONFIGURATION INFORMATION OBJECT DEFINITION.....	141
B.20.1	IOD Description.....	141
B.20.2	IOD Modules	142
B.21	BASIC PRINT IMAGE OVERLAY BOX INFORMATION OBJECT DEFINITION	142
B.21.1	IOD Description	142
B.21.2	IOD Modules	142
B.22	GENERAL PURPOSE SCHEDULED PROCEDURE STEP INFORMATION OBJECT DEFINITION	142
B.22.1	IOD Description.....	142
B.22.2	IOD Modules	142
B.23	GENERAL PURPOSE PERFORMED PROCEDURE STEP INFORMATION OBJECT DEFINITION	143
B.23.1	IOD Description.....	143
B.23.2	IOD Modules	143
Annex C	INFORMATION MODULE DEFINITIONS (NORMATIVE).....	144
C.1	ELEMENTS OF A MODULE DEFINITION	144
C.1.1	Module Description.....	144
C.1.2	Module Definition.....	144
C.1.2.1	Attribute Name	144
C.1.2.2	Attribute Tag	144
C.1.2.3	Type Designation.....	144
C.1.2.4	Attribute Definition	145
C.1.3	Attribute Descriptions	145
C.2	PATIENT MODULES	145
C.2.1	Patient Relationship Module	145
C.2.2	Patient Identification Module.....	146
C.2.3	Patient Demographic Module.....	147

C.2.4	Patient Medical Module.....	148
C.3	VISIT MODULES.....	149
C.3.1	Visit Relationship Module.....	149
C.3.2	Visit Identification Module.....	149
C.3.3	Visit Status Module.....	150
C.3.4	Visit Admission Module.....	150
C.3.5	Visit Discharge Module.....	151
C.3.6	Visit Scheduling Module.....	151
C.4	STUDY MODULES.....	151
C.4.1	Study Relationship Module.....	152
C.4.2	Study Identification Module.....	152
C.4.3	Study Classification Module.....	153
C.4.4	Study Scheduling Module.....	154
C.4.5	Study Acquisition Module.....	155
C.4.6	Study Read Module.....	155
C.4.7	Study Component Module.....	156
C.4.8	Study Component Relationship Module.....	157
C.4.9	Study Component Acquisition Module.....	157
C.4.10	Scheduled Procedure Step Module.....	158
C.4.11	Requested Procedure Module.....	159
C.4.12	Imaging Service Request Module.....	160
C.4.13	Performed Procedure Step Relationship.....	161
C.4.14	Performed Procedure Step Information.....	163
C.4.15	Image Acquisition Results.....	164
C.4.16	Radiation Dose.....	165
C.4.17	Billing and Material Management Codes.....	167
C.4.18	General Purpose Scheduled Procedure Step Relationship Module.....	168
C.4.19	General Purpose Scheduled Procedure Step Information Module.....	169
C.4.20	General Purpose Performed Procedure Step Relationship Module.....	173
C.4.21	General Purpose Performed Procedure Step Information Module.....	175
C.4.22	General Purpose Results.....	176
C.5	RESULTS MODULES.....	177
C.5.1	Results Relationship Module.....	177
C.5.2	Results Identification Module.....	177
C.5.3	Results Impressions Module.....	178
C.6	INTERPRETATION MODULES.....	178
C.6.1	Interpretation Relationship Module.....	178
C.6.2	Interpretation Identification Module.....	178
C.6.3	Interpretation State Module.....	179
C.6.4	Interpretation Recording Module.....	179
C.6.5	Interpretation Transcription Module.....	179
C.6.6	Interpretation Approval Module.....	180
C.7	COMMON COMPOSITE IMAGE IOD MODULES.....	180
C.7.1	Common Patient IE Modules.....	180
C.7.1.1	Patient Module.....	180
C.7.1.2	Specimen Identification Module.....	181
C.7.1.2.1	Specimen Module Attributes.....	182
C.7.1.2.1.2	Specimen Identifier.....	182
C.7.2	Common Study IE Modules.....	183
C.7.2.1	General Study Module.....	183
C.7.2.2	Patient Study Module.....	184
C.7.3	Common Series IE Modules.....	184

C.7.3.1	General Series Module.....	184
C.7.4	Common Frame Of Reference Information Entity Modules	188
C.7.4.1	Frame Of Reference Module	188
C.7.4.2	Synchronization Module	190
C.7.5	Common Equipment IE Modules	191
C.7.5.1	General Equipment Module	191
C.7.6	Common IE Modules	193
C.7.6.1	General Image Module	193
C.7.6.2	Image Plane Module	199
C.7.6.3	Image Pixel Module	200
C.7.6.4	Contrast/Bolus Module.....	206
C.7.6.5	Cine Module.....	207
C.7.6.6	Multi-Frame Module.....	209
C.7.6.7	Bi-Plane Sequence Module (Retired).....	210
C.7.6.8	Bi-Plane Image Module (Retired).....	210
C.7.6.9	Frame Pointers Module.....	210
C.7.6.10	Mask Module	211
C.7.6.11	Display Shutter Module.....	212
C.7.6.12	Device.....	218
C.7.6.13	Therapy	219
C.7.6.14	Acquisition Context Module.....	220
C.7.6.15	Bitmap Display Shutter Module.....	228
C.7.7	Patient Summary Module.....	229
C.7.8	Study Content Module	230
C.7.9	Palette Color Lookup Table Module	231
C.7.9.1	Palette Color Lookup Table UID	232
C.7.9.2	Segmented Palette Color Lookup Table Data	233
C.8	MODALITY SPECIFIC MODULES.....	235
C.8.1	Computed Radiography Modules.....	235
C.8.1.1	CR Series Module	235
C.8.1.2	CR Image Module.....	236
C.8.2	CT Modules	238
C.8.2.1	CT Image Module	238
C.8.3	MR Modules	241
C.8.3.1	MR Image Module	241
C.8.4	Nuclear Medicine Modules	246
C.8.4.1	NM Series Module (Retired).....	246
C.8.4.2	NM Equipment Module (Retired)	246
C.8.4.3	NM Image Module (Retired).....	246
C.8.4.4	NM SPECT Acquisition Image Module (Retired)	246
C.8.4.5	NM Multi-gated Acquisition Image Module (Retired).....	246
C.8.4.6	NM/PET Patient Orientation Module	247
C.8.4.7	NM Image Pixel Module	248
C.8.4.8	NM Multi-frame Module	249
C.8.4.9	NM Image Module	255
C.8.4.10	NM Isotope Module.....	260
C.8.4.11	NM Detector Module.....	263
C.8.4.12	NM TOMO Acquisition Module.....	266
C.8.4.13	NM Multi-gated Acquisition Module	268
C.8.4.14	NM Phase Module.....	269
C.8.4.15	NM Reconstruction Module	270
C.8.5	Ultrasound Modules	272
C.8.5.1	US Frame of Reference Module (Retired).....	272

C.8.5.2 US Region Calibration (Retired).....	272
C.8.5.3 US Image Module (Retired).....	272
C.8.5.4 US Frame of Reference Module	272
C.8.5.5 US Region Calibration Module	274
C.8.5.6 US Image Module	282
C.8.6 Secondary Capture Modules.....	295
C.8.6.1 SC Equipment Module	295
C.8.6.2 SC Image Module.....	296
C.8.6.3 SC Multi-frame Image Module.....	296
C.8.6.4 SC Multi-frame Vector Module	299
C.8.7 X-Ray Modules	301
C.8.7.1 X-Ray Image Module	301
C.8.7.2 X-Ray Acquisition Module.....	305
C.8.7.3 X-Ray Collimator.....	307
C.8.7.4 X-Ray Table Module.....	309
C.8.7.5 XA Positioner Module.....	310
C.8.7.6 XRF Positioner Module.....	314
C.8.7.7 X-Ray Tomography Acquisition Module	315
C.8.7.8 X-Ray Acquisition Dose Module	315
C.8.7.9 X-Ray Generation Module.....	319
C.8.7.10 X-Ray Filtration Module	320
C.8.7.11 X-Ray Grid Module.....	321
C.8.8 Radiotherapy Modules	323
C.8.8.1 RT Series Module.....	323
C.8.8.2 RT Image Module	325
C.8.8.3 RT Dose Module.....	333
C.8.8.4 RT DVH Module	337
C.8.8.5 Structure Set Module.....	339
C.8.8.6 ROI Contour Module	343
C.8.8.7 RT Dose ROI Module	345
C.8.8.8 RT ROI Observations Module.....	346
C.8.8.9 RT General Plan Module	349
C.8.8.10 RT Prescription Module.....	351
C.8.8.11 RT Tolerance Tables Module.....	354
C.8.8.12 RT Patient Setup Module	355
C.8.8.13 RT Fraction Scheme Module	357
C.8.8.14 RT Beams Module.....	362
C.8.8.15 RT Brachy Application Setups Module.....	379
C.8.8.16 Approval Module.....	390
C.8.8.17 RT General Treatment Record Module	390
C.8.8.18 RT Treatment Machine Record Module	391
C.8.8.19 Measured Dose Reference Record Module.....	392
C.8.8.20 Calculated Dose Reference Record Module.....	393
C.8.8.21 RT Beams Session Record Module.....	393
C.8.8.22 RT Brachy Session Record Module.....	404
C.8.8.23 RT Treatment Summary Record Module	413
C.8.9 PET Information Module Definitions	416
C.8.9.1 PET Series Module.....	416
C.8.9.2 PET Isotope Module	425
C.8.9.3 PET Multi-gated Acquisition Module	426
C.8.9.4 PET Image Module	428
C.8.9.5 PET Curve Module.....	434
C.8.10 Hardcopy Modules.....	438
C.8.10.1 Hardcopy Equipment Module.....	438

C.8.10.2	Hardcopy Grayscale Image Module.....	438
C.8.10.3	Hardcopy Color Image Module.....	439
C.8.11	DX Modules.....	440
C.8.11.1	DX Series Module.....	440
C.8.11.2	DX Anatomy Imaged Module.....	443
C.8.11.3	DX Image Module.....	447
C.8.11.4	DX Detector Module.....	453
C.8.11.5	DX Positioning Module.....	461
C.8.11.6	Mammography Series Module.....	472
C.8.11.7	Mammography Image Module.....	472
C.8.11.8	Intra-oral Series Module.....	476
C.8.11.9	Intra-oral Image Module.....	477
C.8.12	VL Modules.....	483
C.8.12.1	VL Image Module.....	483
C.8.12.2	Slide Coordinates Module.....	485
C.9	OVERLAYS.....	489
C.9.1	Overlay identification module.....	489
C.9.2	Overlay plane module.....	489
C.9.2.1	Overlay Attribute Descriptions.....	491
C.9.3	Multi-frame Overlay Module.....	491
C.9.3.1	Multi-Frame Overlay Attribute Descriptions.....	492
C.9.4	Bi-Plane Overlay Module (Retired).....	492
C.9.5	Basic Print Image Overlay Box Module.....	492
C.9.5.1	Overlay or Image Magnification.....	494
C.10	CURVE, GRAPHIC AND WAVEFORM.....	495
C.10.1	Curve identification module.....	495
C.10.2	Curve module.....	496
C.10.2.1	CURVE ATTRIBUTE DESCRIPTIONS.....	497
C.10.3	Audio module.....	499
C.10.3.1	AUDIO SYNCHRONIZATION.....	500
C.10.4	Displayed Area Module.....	501
C.10.5	Graphic Annotation Module.....	506
C.10.5.1	GRAPHIC ANNOTATION ATTRIBUTE DESCRIPTIONS.....	510
C.10.6	Spatial Transformation Module.....	512
C.10.7	Graphic Layer Module.....	513
C.10.8	Waveform Identification Module.....	514
C.10.9	Waveform Module.....	515
C.10.9.1	Waveform Attribute Descriptions.....	518
C.10.9.1.7	Waveform Data.....	521
C.10.10	Waveform Annotation Module.....	521
C.10.10.1	Annotation Attribute Descriptions.....	523
C.11	LOOK UP TABLES.....	525
C.11.1	Modality LUT module.....	525
C.11.1.1	LUT Attribute Descriptions.....	526
C.11.2	VOI LUT module.....	527
C.11.2.1	LUT Attribute Descriptions.....	527
C.11.3	LUT identification module.....	530
C.11.4	Presentation LUT Module.....	531
C.11.5	Image Histogram Module.....	533
C.11.5.1	Image Histogram Attribute Descriptions.....	533
C.11.6	Softcopy Presentation LUT Module.....	534
C.11.6.1	Softcopy Presentation LUT Attributes.....	535

C.11.7	Overlay/Curve Activation Module	537
C.11.8	Softcopy VOI LUT module	539
C.11.9	Presentation Series Module.....	540
C.11.10	Presentation State Module	541
C.12	GENERAL MODULES	544
C.12.1	SOP Common Module	544
C.12.1.1	SOP Common Attribute Descriptions	546
C.13	PRINT MANAGEMENT SPECIFIC MODULES	556
C.13.1	Basic Film Session Presentation Module.....	556
C.13.2	Basic Film Session Relationship Module	556
C.13.3	Basic Film Box Presentation Module.....	558
C.13.3.1	Image display format	561
C.13.4	Basic Film Box Relationship Module	563
C.13.5	Image Box Pixel Presentation Module	564
C.13.5.1	Image Position	567
C.13.6	Image Box Relationship Module (Retired).....	567
C.13.7	Basic Annotation Presentation Module	567
C.13.8	Print Job Module	567
C.13.9	Printer Module.....	568
C.13.9.1	Printer Status Info and Execution Status Info	569
C.13.10	Image Overlay Box Presentation Module (Retired)	572
C.13.11	Image Overlay Box Relationship Module (Retired).....	572
C.13.12	Print Request Module	572
C.13.13	Printer Configuration Module.....	574
C.14	STORAGE COMMITMENT MODULE.....	577
C.14.1	Study Commitment Attribute Description.....	578
C.14.1.1	Failure Reason.....	578
C.15	QUEUE MANAGEMENT SPECIFIC MODULES	579
C.15.1	General Queue Module	579
C.15.2	Print Queue Module.....	580
C.16	STORED PRINT SPECIFIC MODULES	582
C.16.1	Printer Characteristics Module.....	582
C.16.2	Film Box Module	583
C.16.3	Image Box List Module	584
C.16.4	Annotation List Module	585
C.16.5	Image Overlay Box List Module.....	586
C.16.6	Presentation LUT List Module.....	587
C.17	SR DOCUMENT MODULES.....	587
C.17.1	SR Document Series Module	587
C.17.2	SR DOCUMENT GENERAL MODULE	588
C.17.2.1	SOP Instance Reference Macro.....	592
C.17.2.2	Identical Documents Sequence	592
C.17.2.3	Current Requested Procedure Evidence Sequence and Pertinent Other Evidence Sequence	593
C.17.3	SR Document Content Module	593
C.17.3.1	Concept Name Code Sequence.....	604
C.17.3.2	Continuity of Content	604
C.17.4	SR Content Tree Example (Informative).....	605
C.17.5	OBSERVATION CONTEXT ENCODING	606
C.17.6	Key Object Selection Modules	609
C.17.6.1	Key Object Document Series Module.....	609

C.17.6.2 Key Object Document Module.....	609
C.18 CONTENT MACROS.....	611
C.18.1 Numeric Measurement Macro	611
C.18.2 Code Macro.....	611
C.18.3 Composite Object Reference Macro.....	612
C.18.4 Image Reference Macro.....	612
C.18.5 Waveform Reference Macro	613
C.18.5.1 Waveform Reference Macro Attribute Descriptions	613
C.18.6 Spatial Coordinates Macro.....	613
C.18.6.1 Spatial Coordinates Macro Attribute Descriptions	614
C.18.7 Temporal Coordinates Macro.....	615
Annex D Codes and Controlled Terminology (Informative).....	617
Annex E Explanation of patient orientation (Normative)	624
Annex F Basic Directory Information Object Definition (Normative).....	637
F.1 SCOPE OF THE BASIC DIRECTORY INFORMATION IOD.....	637
F.2 BASIC DIRECTORY IOD OVERVIEW	638
F.2.1 Basic directory IOD organization.....	638
F.2.2 Example of a directory	640
F.2.2.1 ILLUSTRATION OF THE OVERALL DIRECTORY ORGANIZATION	640
F.2.2.2 EXAMPLE OF A DICOM DIR FILE STRUCTURE	642
F.3 BASIC DIRECTORY INFORMATION OBJECT DEFINITION	644
F.3.1 Module table	644
F.3.2 Modules of the basic directory information object.....	644
F.3.2.1 FILE-SET IDENTIFICATION MODULE	644
F.3.2.2 DIRECTORY INFORMATION MODULE	645
F.4 BASIC DIRECTORY IOD INFORMATION MODEL	649
F.5 DEFINITION OF SPECIFIC DIRECTORY RECORDS	650
F.5.1 Patient Directory Record Definition.....	652
F.5.2 Study Directory record definition	652
F.5.3 Series Directory Record Definition.....	653
F.5.4 Image directory record definition.....	654
F.5.5 Standalone overlay directory record definition	654
F.5.6 Standalone modality LUT directory record definition	655
F.5.7 Standalone VOI LUT directory record definition.....	655
F.5.8 Standalone curve directory record definition.....	656
F.5.9 Topic directory record definition.....	656
F.5.10 Visit directory record definition.....	657
F.5.11 Results directory record definition	657
F.5.12 Interpretation directory record definition.....	658
F.5.13 Study component directory record definition.....	659
F.5.14 Print Queue Directory Record Definition.....	659
F.5.15 Film session directory record definition.....	659
F.5.16 Film box directory record definition.....	660
F.5.17 Basic image box directory record definition	660
F.5.18 Stored Print Directory Record Definition.....	660
F.5.19 RT Dose Directory Record Definition	661
F.5.20 RT Structure Set Directory Record Definition.....	662
F.5.21 RT Plan Directory Record Definition	662
F.5.22 RT Treatment Record Directory Record Definition	663
F.5.23 Presentation State Directory Record Definition	663

F.5.24	Waveform_Directory Record Definition.....	664
F.5.25	SR Document Directory Record Definition.....	665
F.5.26	Key Object Document Directory Record Definition.....	666
F.6	SPECIAL DIRECTORY RECORDS	667
F.6.1	Private directory record definition.....	667
F.6.2	Multi-referenced file directory record definition	667
F.7	ICON IMAGE KEY DEFINITION.....	668
Annex G	Integration of Modality Worklist and Modality Performed Procedure Step in the Original DICOM Standard (Informative)	669
Annex H	Retired	672
Annex I	Retired	673
Annex J	Waveforms (Informative).....	674
J.1	DOMAIN OF APPLICATION.....	674
J.2	USE CASES	674
J.3	TIME SYNCHRONIZATION FRAME OF REFERENCE.....	675
J.4	WAVEFORM ACQUISITION MODEL.....	675
J.5	WAVEFORM INFORMATION MODEL.....	676
J.6	HARMONIZATION WITH HL7	677
J.6.1	HL7 Waveform Observation.....	677
J.6.2	Channel Definition.....	678
J.6.3	Timing	679
J.6.4	Waveform Data.....	679
J.6.5	Annotation	679
J.7	HARMONIZATION WITH SCP-ECG	679
Annex K	(informative).....	681
Annex L	Mammography CAD (Informative).....	689
L.1	Mammography CAD SR Content Tree Structure.....	689
L.2	Mammography CAD SR Observation Context Encoding.....	691
L.3	Mammography CAD SR Examples	692
Example 1:	Calcification and Mass Detection with No Findings.....	692
Example 2:	Calcification and Mass Detection with Findings.....	694
Example 3:	Calcification and Mass Detection, Temporal Differencing with Findings.....	708
Annex M	Index	720

FOREWORD

The American College of Radiology (ACR) and the National Electrical Manufacturers Association (NEMA) formed a joint committee to develop a standard for Digital Imaging and Communications in Medicine (DICOM). This DICOM Standard was developed according to the NEMA procedures.

This standard is developed in liaison with other standardization organizations including CEN TC251 in Europe and JIRA in Japan, with review also by other organizations including IEEE, HL7 and ANSI in the USA.

The DICOM Standard is structured as a multi-part document using the guidelines established in the following document:

— ISO/IEC Directives, 1989 Part 3 : Drafting and Presentation of International Standards.

This document is one part of the DICOM Standard which consists of the following parts:

PS 3.1: Introduction and Overview

PS 3.2: Conformance

PS 3.3: Information Object Definitions

PS 3.4: Service Class Specifications

PS 3.5: Data Structures and Encoding

PS 3.6: Data Dictionary

PS 3.7: Message Exchange

PS 3.8: Network Communication Support for Message Exchange

PS 3.9: Point-to-Point Communication Support for Message Exchange

PS 3.10: Media Storage and File Format for Media Interchange

PS 3.11: Media Storage Application Profiles

PS 3.12: Formats and Physical Media

PS 3.13: Print Management Point-to-Point Communication Support

PS 3.14: Grayscale Standard Display Function

PS 3.15: Security Profiles

PS 3.16: Content Mapping Resource

These parts are related but independent documents. Their development level and approval status may differ. Additional parts may be added to this multi-part standard. PS 3.1 should be used as the base reference for the current parts of this standard.

1 Scope and field of application

This Part of the DICOM Standard specifies the set of Information Object Definitions (IODs) which provide an abstract definition of real-world objects applicable to communication of digital medical information. For each IOD, this Part specifies:

- any necessary information for the semantic description of the IOD
- relationships to associated real-world objects relevant to the IOD
- Attributes which describe the characteristics of the IOD

For each IOD, this Part does not specify:

- the nature of any Service Class Definition intended to reference the IOD
- the nature of any interactions which result in the usage of the IOD

This Part is related to other parts of the DICOM Standard in that:

- PS 3.4, Service Class Specifications, specifies application level services by grouping DIMSE services with IODs as defined in this Part;
- PS 3.5, Data Structure and Semantics, defines the data encoding used in the DIMSE Protocol when applied to IODs defined in this Part;
- PS 3.6, Data Dictionary, contains an index by Tag of all IOD Attributes defined in this Part. This index includes the Value Representation and Value Multiplicity for each Attribute;
- PS 3.7, Message Exchange Protocol, defines the DIMSE Services and Protocol which may be applied to IODs defined in this Part.

2 Normative references

The following standards contain provisions which, through reference in this text, constitute provisions of this Standard. At the time of publication, the editions indicated were valid. All standards are subject to revision, and parties to agreements based on this Standard are encouraged to investigate the possibilities of applying the most recent editions of the standards indicated below.

ISO/IEC Directives, 1989 Part 3 - Drafting and Presentation of International Standards

ISO 7498-1, Information Processing Systems - Open Systems Interconnection - Basic Reference Model

ISO/TR 8509, Information Processing Systems - Open Systems Interconnection - Service Conventions

ISO/IEC 2022:1994 Information technology - Character code structure and extension techniques.

AIUM and NEMA Standard for Real-Time Display of Thermal and Mechanical Acoustic Output Indices on Diagnostic Ultrasound Equipment.

IEC Standard 61217, Radiotherapy Equipment - Coordinates, Movements and Scales (Reference CEI/IEC 61217: 1996)

ICRU Report 50, Prescribing, Recording, and Reporting Photon Beam Therapy, International Commission on Radiation Units and Measurements, 1993

Breast Imaging Reporting and Data System (BI-RADS), 3rd Edition 1998, American College of Radiology.

ISO 3950-1984, Dentistry - Designation system for teeth and areas of the oral cavity.

ITU-T Recommendation G.711 (1988) - Pulse code modulation (PCM) of voice frequencies

TIS 620-2533 (1990) Thai Characters Code for Information Interchange

ITU-T Recommendation X.509 (03/00), Information technology - Open Systems Interconnection - The directory: Public-key and attribute certificate frameworks

Note: ITU-T Recommendation X.509 is similar to ISO/IEC 9594-8 1990. However, the ITU-T recommendation is the more familiar form, and was revised in 1993 and 2000, with two sets of corrections in 2001. ITU-T was formerly known as CCITT.

ISO/IEC 10118-3:1998, Information technology – Security techniques – Hash-functions – Part 3: Dedicated hash-functions (RIPEMD-160 reference)

Note: The draft RIPEMD-160 specification and sample code are also available at <ftp://ftp.esat.kuleuven.ac.be/pub/bosselaer/ripemd>

IETF RFC 2437, PKCS #1 RSA Cryptography Specifications Version 2.0

Note: The RSA Encryption Standard is also defined in informative annex A of ISO/IEC 9796, and in Normative Annex A of the CEN/TC251 European Prestandard prENV 12388:1996.

ISO 7498-2, Information processing systems – Open Systems Interconnection – Basic reference Model – Part 2: Security Architecture

ECMA 235, The ECMA GSS-API Mechanism

FIPS PUB 46, Data Encryption Standard

FIPS PUB 81, DES Modes of Operation

IETF, Internet X.509 Public Key Infrastructure; Time Stamp Protocols; March 2000

3 Definitions

For the purposes of this Standard the following definitions apply.

3.1 Reference model definitions

This Part of the Standard is based on the concepts developed in ISO 7498-1 and makes use of the following terms defined in it:

- a. Application Entity

- b. Service or Layer Service

3.2 Service conventions definitions

This Part of the Standard makes use of the following terms defined in ISO/TR 8509:

- a. Primitive

3.3 DICOM introduction and overview definitions

This Part of the Standard makes use of the following terms defined in PS 3.1:

- a. Attribute
- b. Command
- c. Data Dictionary
- d. Message

3.4 DICOM service class specifications

This Part of the Standard makes use of the following terms defined in PS 3.4:

- a. Real-World Activity
- b. Real-World Object
- c. Service Class
- d. Service Class User
- e. Service Class Provider
- f. Service-Object Pair (SOP) Class
- g. Service-Object Pair (SOP) Instance
- h. Preformatted Grayscale Image
- i. Preformatted Color Image

3.5 DICOM data structures and encoding

This Part of the Standard makes use of the following terms defined in PS 3.5:

- a. Data Element
- b. Data Element Tag
- c. Data Element Type
- d. Data Set
- e. Defined Term
- f. Enumerated Value
- g. Sequence of Items
- h. Unique Identifier (UID)

3.6 DICOM message exchange

This Part of the Standard makes use of the following terms defined in PS 3.7:

- a. DICOM Message Service Element (DIMSE)

- b. DIMSE-N Services
- c. DIMSE-C Services

3.7 DICOM upper layer service

This Part of the Standard makes use of the following terms defined in PS 3.8:

- a. DICOM Upper Layer Service

3.8 DICOM Information Object

The following definitions are commonly used in this part of the Standard:

3.8.1 Attribute tag: A unique identifier for an Attribute of an Information Object composed of an ordered pair of numbers (a Group Number followed by an Element number).

3.8.2 Composite IOD: an Information Object Definition which represents parts of several entities in the DICOM Application Model. Such an IOD includes Attributes which are not inherent in the Real-World Object that the IOD represents but rather are inherent in related Real-World Objects.

3.8.3 Derived image: an image in which the pixel data was constructed from pixel data of one or more other images (source images).

3.8.4 DICOM information model: an Entity-Relationship diagram which is used to model the relationships between the Information Object Definitions representing classes of Real-World Objects defined by the DICOM Application Model.

3.8.5 DICOM application model: an Entity-Relationship diagram used to model the relationships between Real-World Objects which are within the area of interest of the DICOM Standard.

3.8.6 Information entity: that portion of information defined by a Composite IOD which is related to one specific class of Real-World Object. There is a one-to-one correspondence between Information Entities and entities in the DICOM Application Model.

3.8.7 Information object definition (IOD): a data abstraction of a class of similar Real-World Objects which defines the nature and Attributes relevant to the class of Real-World Objects represented.

3.8.8 Module: A set of Attributes within an Information Entity or Normalized IOD which are logically related to each other.

3.8.9 Multi-frame image: Image that contains multiple two-dimensional pixel planes.

3.8.10 Normalized IOD: an Information Object Definition which represents a single entity in the DICOM Application Model. Such an IOD includes Attributes which are only inherent in the Real-World Object that the IOD represents.

3.8.11 Cine run: A set of temporally related frames acquired at constant or variable frame rates. This term incorporates the general class of serialography.

Note: A Cine run is typically encoded as a multi-frame image.

3.8.12 Specialization: Specialization is the replacement of the Type, value range and/or description of an Attribute in a general Module of an IOD, by its Type, value range and/or description defined in a modality-specific Module of an IOD.

Note: The same Attribute may be present in multiple Modules in the same IOD but not specified to be "Specialized".

3.9 Character Handling Definitions

This part of the standard makes use of the following terms defined in ISO/IEC 2011:1994:

- a. Coded character set; code.
- b. Code extension;
- c. Escape sequence.

3.10 Radiotherapy

This Part of the Standard is based on the concepts developed in IEC 61217 and makes use of the following terms defined in it:

- a. FIXED REFERENCE system
- b. GANTRY system
- c. BEAM LIMITING DEVICE system
- d. WEDGE FILTER system
- e. X-RAY IMAGE RECEPTOR system
- f. PATIENT SUPPORT system
- g. TABLE TOP ECCENTRIC system
- h. TABLE TOP system

3.11 Attribute Macro: a set of Attributes that are described in a single table that is referenced by multiple Module or other tables.

3.12 DICOM Grayscale Standard Display Function

This Part of the Standard makes use of the following terms defined in PS 3.14:

- a. P-Value

Note: The definition is "A device independent value defined in a perceptually linear grayscale space. The output of the DICOM Presentation LUT is P-Values, i.e. the pixel value after all DICOM defined grayscale transformations have been applied. P-Values are the input to a Standardized Display System."

3.13 CODES AND CONTROLLED TERMINOLOGY DEFINITIONS:

The following definitions are used:

3.13.1 Retired

3.13.2 Baseline Context Group: Context Group that specifies the suggested Value Set for a Code Sequence Attribute.

3.13.3 Defined Context Group: Context Group that specifies the Value Set for a Code Sequence Attribute that shall be used, but may be extended.

- 3.13.4 Enumerated Context Group:** Context Group that specifies the Value Set for a Code Sequence Attribute that shall be used and shall not be extended.
- 3.13.5 Code Sequence Attribute:** Attribute that (usually) includes the string "Code Sequence" in the Attribute Name and has a VR of SQ (Sequence of Items). Its purpose is to encode concepts using code values and optional text meanings from coding schemes. Sections 8.1 through 8.8 specify the Attributes of which the Sequence Items (Attribute Sets) of Code Sequence Attributes are constructed.
- 3.13.6** Retired.
- 3.13.7 Context Group:** Attribute Value Set defined by a Mapping Resource.
- 3.13.8 Context Group Version:** Version of a Context Group.
- 3.13.9 Context ID (CID):** Identifier of a Context Group.
- 3.13.10** Retired.
- 3.13.11 Mapping Resource:** A resource that defines context-dependent usage constraints (i.e. Value Set or Relationship Type restrictions) for Attributes. A resource that specifies the mapping of the content of an external controlled terminology to the components of a message standard.
- 3.13.12** Retired.
- 3.13.13** Retired.
- 3.13.14** Retired.
- 3.13.15 Relationship Type:** The association between two Concepts. Examples: "HAS PROPERTIES", "CONTAINS", "INFERRED FROM".
- 3.13.16 DICOM Content Mapping Resource (DCMR):** A Mapping Resource that defines Templates and Context Groups for use in DICOM IODs.
- 3.13.17 Template:** A pattern that describes the Content Items, Value Types, Relationship Types and Value Sets that may be used in part of a Structured Report content tree, or in other coded entry items, such as Acquisition Context or Waveform Channel Description. Analogous to a Module of an Information Object Definition.
- 3.13.18 Template ID (TID):** Identifier of a Template.
- 3.13.19** Retired.
- 3.13.20 Value Set:** The allowed values of a Code Sequence Attribute in a given context. Specified either as one or more individual values or by reference to a Context Group.
- 3.13.21 Baseline Template:** A template suggested in an IOD which may be used in the creation of a SOP Instance, replaced by another template or extended.
- 3.13.22 Defined Template:** A template defined in an IOD that specifies an extensible set of Content Items and corresponding Value Sets. A SOP Instance may optionally include additional Content Items beyond those specified in the template .

3.13.23 Enumerated Template: A template defined in an IOD that specifies the exact set of Content Items and corresponding Value Sets that shall be used and which shall not be extended. A SOP Instance shall be created according to the exact Template specification and shall not include additional Content Items.

3.13.24 Coding schemes: Dictionaries (lexicons) of terms with well defined meanings.

Note: Examples of coding schemes include SNOMED and LOINC.

3.14 Reference Model Security Architecture Definitions

This Part of the Standard makes use of the following terms defined in ISO 7498-2:

a. Digital Signature

Note: The definition is "Data appended to, or a cryptographic transformation of, a data unit that allows a recipient of the data unit to prove the source and integrity of that unit and protect against forgery e.g. by the recipient."

a. Data Confidentiality

Note: The definition is "the property that information is not made available or disclosed to unauthorized individuals, entities or processes."

b. Data Origin Authentication

Note: The definition is "the corroboration that the source of data received is as claimed."

c. Data Integrity

Note: The definition is "the property that data has not been altered or destroyed in an unauthorized manner."

d. Key Management

Note: The definition is "the generation, storage, distribution, deletion, archiving and application of keys in accordance with a security policy."

3.15 Security Definitions

This Part of the Standard makes use of the following terms defined in ECMA 235:

a. Security Context

Note: The definition is "security information that represents, or will represent a Security Association to an initiator or acceptor that has formed, or is attempting to form such an association."

3.16 DICOM security profiles

This part of the Standard makes use of the following terms defined in PS 3.15:

- a. Message Authentication Code
- b. Certificate

4 Symbols and abbreviations

The following symbols and abbreviations are used in this Part of the Standard.

ACR	American College of Radiology
ASCII	American Standard Code for Information Interchange
AE	Application Entity
ANSI	American National Standards Institute
BEV	Beam's-eye view
Brachy	Brachytherapy
BRHC	Bottom Right Hand Corner
CC	Counter-clockwise
CEN TC251	Comite European de Normalisation-Technical Committee 251-Medical Informatics
CCIR	Consultative Committee, International Radio
CTV	Clinical target volume
CW	Clockwise
DICOM	Digital Imaging and Communications in Medicine
DIMSE	DICOM Message Service Element
DIMSE-C	DICOM Message Service Element-Composite
DIMSE-N	DICOM Message Service Element-Normalized
DRR	Digitally-reconstructed radiograph
DVH	Dose-volume histogram
EPI	Electronic Portal Image
EPID	Electronic Portal Imaging Device
GTV	Gross tumor volume
Gy	Gray
HISPP	Healthcare Information Standards Planning Panel
HL7	Health Level 7
ICRU	International Commission on Radiation Units
IE	Information Entity
IEC	International Electrotechnical Commission
IEEE	Institute of Electrical and Electronics Engineers
IOD	Information Object Definition
ISO	International Standards Organization
ITU-T	International Telecommunications Union – Telecommunications Standardization Sector
JIRA	Japan Industries Association of Radiation Apparatus
LUT	Lookup Table
MAC	Message Authentication Code

Mammography CAD	Computer-Aided Detection and/or Computer-Aided Diagnosis for Mammography
MeV	Mega electron Volt
MLC	Multileaf (multi-element) collimator
MSDS	Healthcare Message Standard Developers Sub-Committee
MU	Monitor unit
MV	Megavolt
NEMA	National Electrical Manufacturers Association
OSI	Open Systems Interconnection
PTV	Planning target volume
R&V	Record and verify
ROI	Region of interest
RT	Radiotherapy
SAD	Source-axis distance
SCP	Service Class Provider
SCU	Service Class User
SID	Source-image distance
SOP	Service-Object Pair
SSD	Source-skin distance
TLHC	Top Left Hand Corner
UID	Unique Identifier

5 Conventions

5.1 ENTITY-RELATIONSHIP MODEL

5.1.1 ENTITY

An entity is used in an Entity-Relationship (E-R) model to represent a Real-World Object, class of Real-World Objects, or DICOM data representation (such as an IOD or Module). An entity is depicted as shown in Figure 5.1-1.

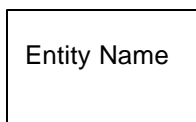
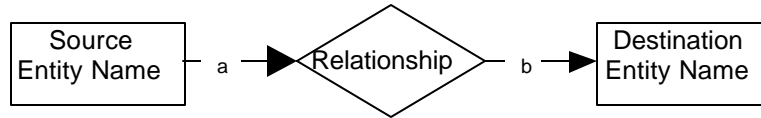

Figure 5.1-1
ENTITY CONVENTION

5.1.2 RELATIONSHIP

A relationship, which defines how entities are related, is depicted as a diamond within this Part of the DICOM Standard as shown in Figure 5.1-2.



**Figure 5.1-2
RELATIONSHIP CONVENTION**

The relationship is read from source to destination entity as indicated by the arrows. The a and b show the source and destination cardinality of the relationship respectively. The following cardinalities are permitted:

- a. (a = 1, b = 1) - one source entity is related to one destination entity
- b. (a = 1, b = 0-n) - one source entity is related to zero or more destination entities
- c. (a = 1, b = 1-n) - one source entity is related to one or more destination entities
- d. (a = 1-n, b = 1) - one or more source entities are related to one destination entity
- e. (a = 1-n, b = 0-n) - one or more source entities are related to zero or more destination entities
- f. (a = 1-n, b = 1-n) - one or more source entities are related to one or more destination entities

In a relationship where (a = 1-n, b = 1-n) the values of the source and destination cardinalities may be different. The value "n" simply denotes one or more.

Note: DICOM has added the use of arrows to the E-R diagramming conventions often used in other literature. This has been done to avoid the possibility of inferring an incorrect relationship which can result from reading a relationship in the reverse order of that intended. For example, a relationship "Cat Catches Mouse" could be read "Mouse Catches Cat" if the arrows were not present.

A relationship may be bi-directional (i.e. the relationship is true in both directions). In such a case, the convention used is arrows pointing toward both the source and the destination entities.

5.2 SEQUENCES

Certain Tables in this Standard describe Sequences of Items by using the symbol: '>'. The symbol '>' precedes the Attribute (or Module) Name of the members of an Item. All marked Attributes (or Modules) belong to the generic description of an Item which may be repeated to form a Sequence of Items. This Sequence of Items is nested in the Attribute (or Module) which precedes in the table the first member marked with a '>'.

Note: The following table describes the "Referenced Series Sequences" Attribute as a Sequence of one or more Items where each Item contains the three Attributes marked by a '>'. The Sequence of Items is nested inside the value of the Referenced Series Sequence Attribute. The following Attribute (not marked) is not part of the Items of the Sequence.

.....
Referenced Series Sequence

> Series Date
> Series Time
> Series Instance UID
Modality

This notation may be used to create nested hierarchical structures by using '>' at the second level of nesting and so on

5.3 TRIPLET ENCODING OF STRUCTURED DATA (RETIRED)

This section has been retired. See Section 8.

5.4 ATTRIBUTE MACROS

Some tables contain references to Attribute Macros. This convention is used in cases where the same Attributes are used in multiple tables or multiple places in one Module. The reference means that the Attributes of the Attribute Macro shall be included in the Module in place of the row that contains the reference to the Attribute Macro.

In some cases, the Attribute Macro is used in a Sequence (the VR of the Data Element in which the Attribute is encoded is SQ, see PS 3.5). When this is done, the reference is preceded by one or more ">" characters. The number of ">" characters indicates the level in the sequence that all of the Attributes in the Attribute Macro occupy.

There may be specialization of the description of the Attributes in the Attribute Macro. In these cases, this specialization is described in the Description column of the Module.

When Attribute Macros are invoked in the definition of Normalized Objects in PS3.3 the specified Requirement Types and Conditions do not apply. In PS3.4 Requirement Types and Conditions have to be specified for both SCU and SCP with each invocation of an Attribute Macro.

Following is an example of this convention.

Table 5.4-1 is an example of a Module table using the Attribute Macro convention.

**Table 5.4-1
Example Module Table**

Attribute Name	Tag	Type	Attribute Description
Attribute A	(aaaa,aaaa)	1	This is an example.
Attribute B Sequence	(bbbb,bbbb)	1	This is an example of a Sequence Attribute
>Include 'Example Macro' Table 5.4-2			<i>In this Module, Attribute D (dddd,dddd) is Type 1</i>

Table 5.4-2 is an example of the Attribute Macro referenced in Table 5.4-1.

**Table 5.4-2
Example Macro**

Attribute Name	Tag	Type	Attribute Description
Attribute C	(cccc,cccc)	1	This is an example.

Attribute D	(dddd,dddd)	3	This Attribute is generally a Type 3.
-------------	-------------	---	---------------------------------------

The contents of the Example Module Table, if it had not been described with the Example Macro would have been as shown in Table 5.4-3

Table 5.4-3
Example Module Table without the Use of an Attribute Macro

Attribute Name	Tag	Type	Attribute Description
Attribute A	(aaaa,aaaa)	1	This is an example.
Attribute B Sequence	(bbbb,bbbb)	1	This is an example of a Sequence Attribute.
>Attribute C	(cccc,cccc)	1	This is an example.
>Attribute D	(dddd,dddd)	1	In this Module, this Attribute has been specialized to Type 1 as indicated in Table 5.4-1.

6 DICOM information model

The DICOM Information Model defines the structure and organization of the information related to the communication of medical images. Figure 6-1 shows the relationships between the major structures of the DICOM Information Model.

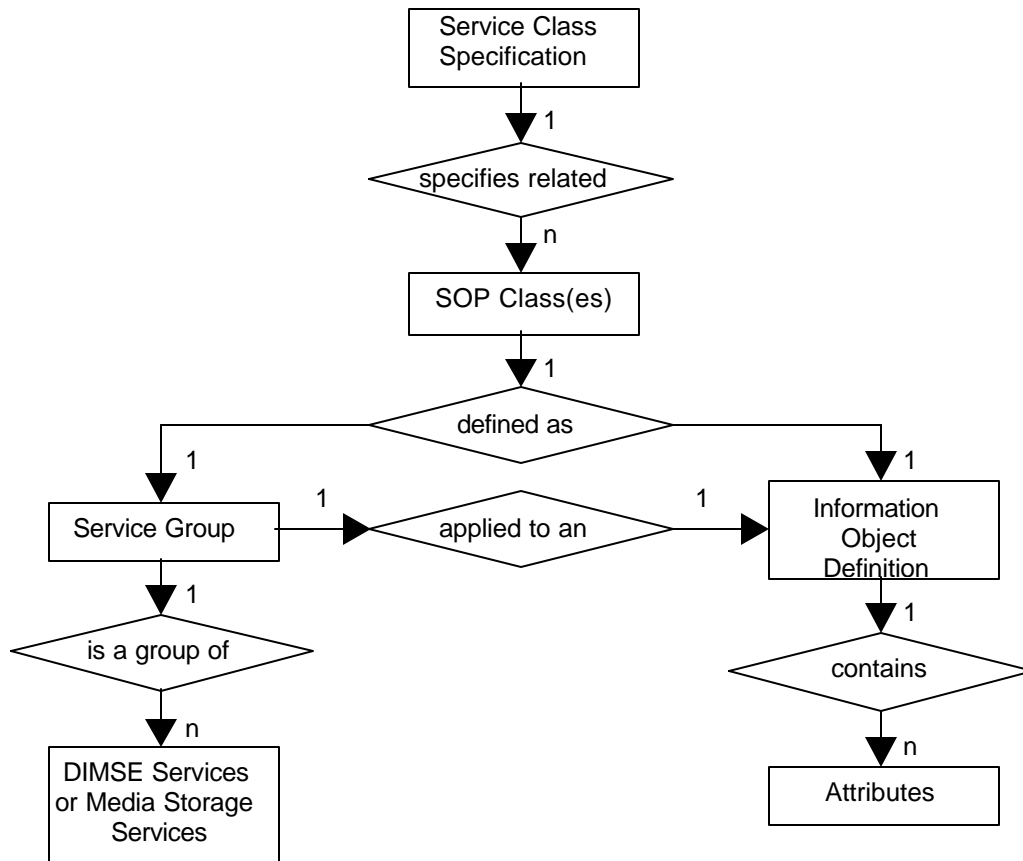

Figure 6-1
MAJOR STRUCTURES OF DICOM INFORMATION MODEL

6.1 INFORMATION OBJECT DEFINITION

An Information Object Definition (IOD) is an object-oriented abstract data model used to specify information about Real-World Objects. An IOD provides communicating Application Entities with a common view of the information to be exchanged.

An IOD does not represent a specific instance of a Real-World Object, but rather a class of Real-World Objects which share the same properties. An IOD used to generally represent a single class of Real-World Objects is called a Normalized Information Object. An IOD which includes information about related Real-World Objects is called a Composite Information Object.

6.1.1 COMPOSITE IOD

A Composite IOD is an Information Object Definition which represents parts of several entities included in the DICOM Model of the Real-World. This Model is introduced in Section 7. Such an IOD includes Attributes which are not inherent in the Real-World Object that the IOD represents but rather are inherent in related Real-World Objects.

These related Real-World Objects provide a complete context for the exchanged information. When an instance of a Composite IOD is communicated, this entire context is exchanged between Application Entities. Relationships between Composite IOD Instances shall be conveyed in this contextual information.

The Composite IODs are specified in Annex A.

6.1.2 NORMALIZED IOD

A Normalized IOD is an Information Object Definition which generally represents a single entity in the DICOM Model of the Real-World.

In this Standard, strict definition of Normalized Object Definitions has not been applied. Application of strict definitions would often result in unnecessary complexity and reduced performance of implementations for several applications.

Note: An example is the Print Queue IOD. Attributes from the Basic and Referenced Print Management IODs are combined in the Print Queue IOD. This allows an SCP to provide all relevant information in a single N-Get Service Element. Otherwise several Service Elements would be required to return the attributes from individual Normalized IODs. This requires less network traffic to convey the information, thus improving system performance.

The Print Queue IOD has been classified as a Normalized IOD to allow operations by DIMSE-N Services since most devices which support the Print Queue Management SOP Class also support the Basic Print Management Meta SOP Class in which the DIMSE-N Service Elements are used. This facilitates efficient implementations of the Print Queue Management SOP Class.

When an instance of a Normalized IOD is communicated, the context for that instance is not actually exchanged. Instead, the context is provided through the use of pointers to related Normalized IOD Instances.

The Normalized IODs are specified in Annex B.

6.2 ATTRIBUTES

The Attributes of an IOD describe the properties of a Real-World Object Instance. Related Attributes are grouped into Modules which represent a higher level of semantics documented in the Module Specifications found in Annex C.

Attributes are encoded as Data Elements using the rules, the Value Representation and the Value Multiplicity concepts specified in PS 3.5. For specific Data Elements, the Value Representation and Value Multiplicity are specified in the Data Dictionary in PS 3.6.

When multiple modules containing the same Attributes(s) are included in an IOD, the Attribute shall be encoded only once into a Data Element.

6.3 ON-LINE COMMUNICATION AND MEDIA STORAGE SERVICES

For on-line communication the DIMSE Services allow a DICOM Application Entity to invoke an operation or notification across a network or a point-to-point interface. DIMSE Services are defined in PS 3.7.

For media storage interchange, Media Storage Services allow a DICOM Application Entity to invoke media storage related operations.

Note: These Media Storage Services are discussed in PS 3.10.

6.3.1 DIMSE-C SERVICES

DIMSE-C Services are services applicable only to a Composite IOD. DIMSE-C Services provide only operation services.

6.3.2 DIMSE-N SERVICES

DIMSE-N Services are services applicable only to a Normalized IOD. DIMSE-N Services provide both operation and notification services.

6.4 DIMSE SERVICE GROUP

A DIMSE Service Group specifies one or more operations/notifications defined in PS 3.7 which are applicable to an IOD.

DIMSE Service Groups are defined in PS 3.4 in the specification of a Service-Object Pair Class.

6.5 SERVICE-OBJECT PAIR (SOP) CLASS

A Service-Object Pair (SOP) Class is defined by the union of an IOD and a DIMSE Service Group. The SOP Class definition contains the rules and semantics which may restrict the use of the services in the DIMSE Service Group and/or the Attributes of the IOD.

The selection of SOP Classes is used by Application Entities to establish an agreed set of capabilities to support their interaction. This negotiation is performed at association establishment time as described in PS 3.7. An extended negotiation allows Application Entities to further agree on specific options within a SOP Class.

Note: The SOP Class as defined in the DICOM Information Model is equivalent in ISO/OSI terminology to the Managed Object Class. Readers familiar with object oriented terminology will recognize the SOP Class operations (and notifications) as comprising the methods of an object class.

6.5.1 NORMALIZED AND COMPOSITE SOP CLASSES

DICOM defines two types of SOP Classes, Normalized and Composite. Normalized SOP Classes are defined as the union of a Normalized IOD and a set of DIMSE-N Services. Composite SOP Classes are defined as the union of a Composite IOD and a set of DIMSE-C Services.

Note: SOP Class Specifications play a central role for defining DICOM conformance requirements. It allows DICOM Application Entities to select a well-defined application level subset of the DICOM V3.0 Standard to which they may claim conformance. See PS 3.2.

6.6 ASSOCIATION NEGOTIATION

Association establishment is the first phase of communication between peer DICOM compliant Application Entities. The Application Entities shall use association establishment to negotiate which SOP Classes can be exchanged and how this data will be encoded.

Association Negotiation is defined in PS 3.7.

6.7 SERVICE CLASS SPECIFICATION

A Service Class Specification defines a group of one or more SOP Classes related to a specific function which is to be accomplished by communicating Application Entities. A Service Class Specification also

defines rules which allow implementations to state some pre-defined level of conformance to one or more SOP Classes. Applications may conform to SOP Classes as either a Service Class User (SCU) or Service Class Provider (SCP).

Service Class Specifications are defined in PS 3.4.

Note: Such interaction between peer Application Entities work on a 'client/server model'. The SCU acts as the 'client', while the SCP acts as the 'server'. The SCU/SCP roles are determined during association establishment.

7 DICOM model of the real-world

Figures 7-1a, 7-1b and 7-3 depict the DICOM view of the Real-World which identifies the relevant Real-World Objects and their relationships within the scope of the DICOM Standard. It provides a common framework to ensure consistency between the various Information Objects defined by the DICOM Standard.

Note: The relationship between study and result is complex, involving other Real-World Objects (e.g. the interpreting physician). This Standard does not model these objects.

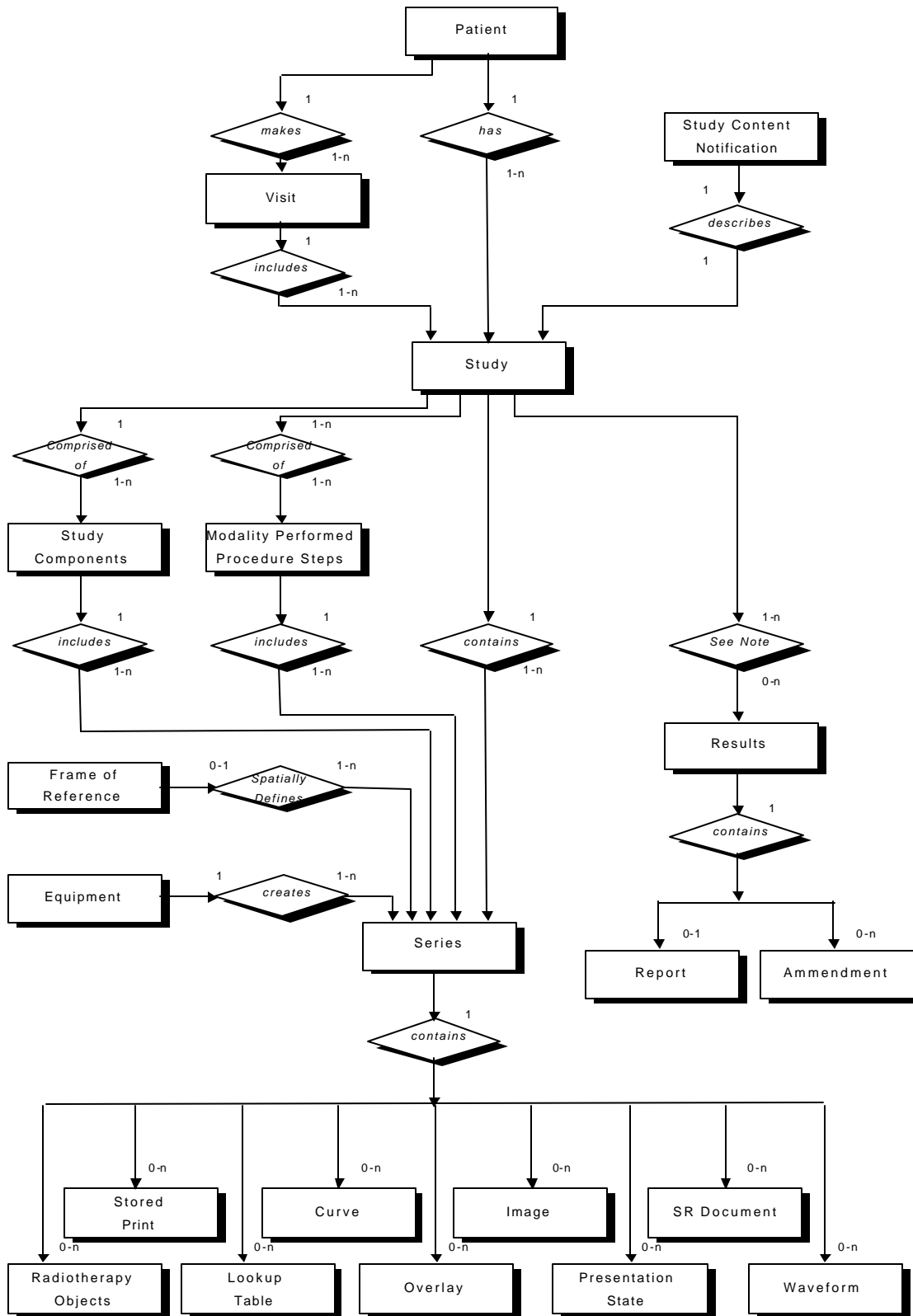

Figure 7-1a
DICOM MODEL OF THE REAL-WORLD

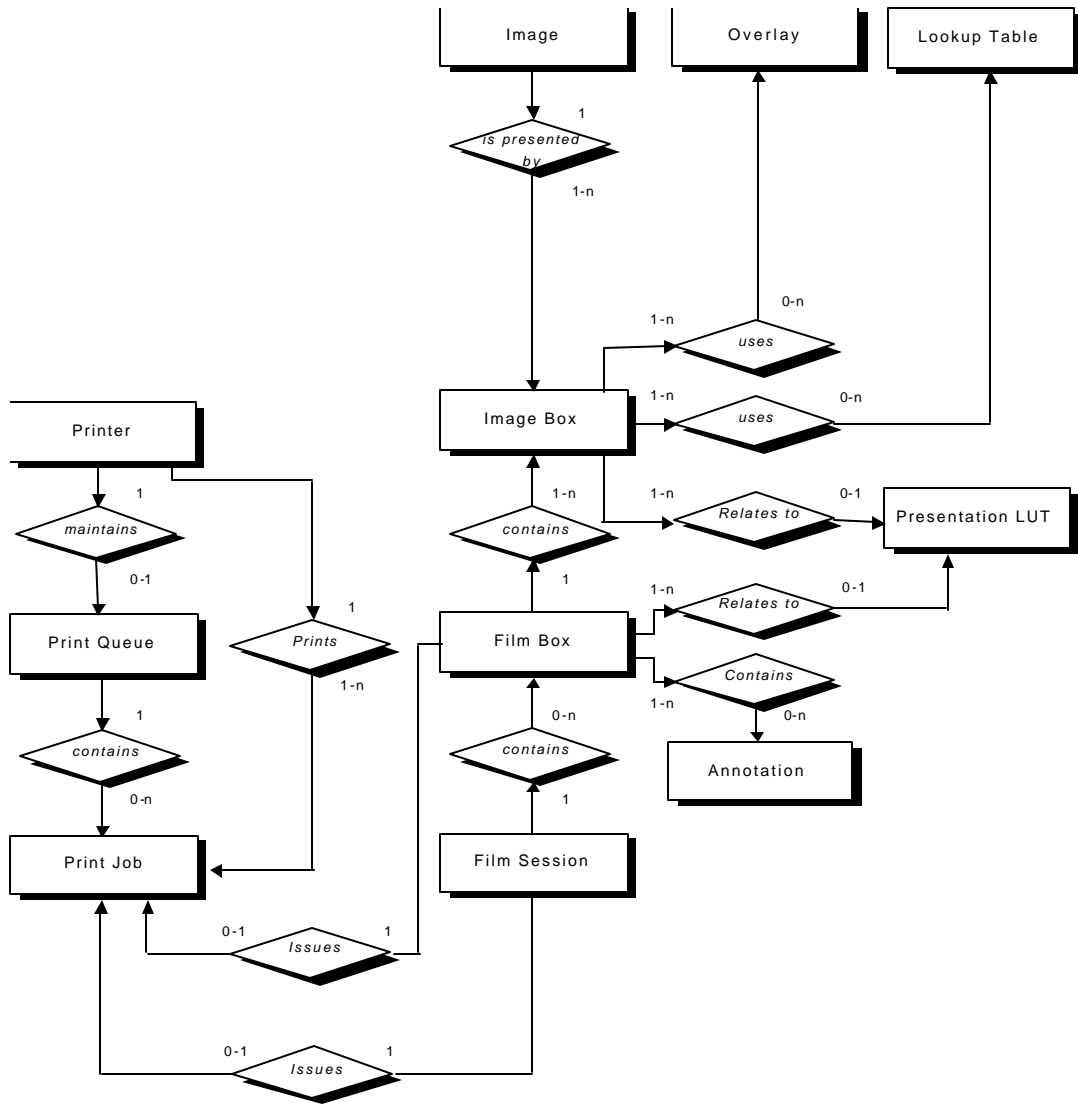

Figure 7-1b
DICOM MODEL OF THE REAL-WORLD - PRINT

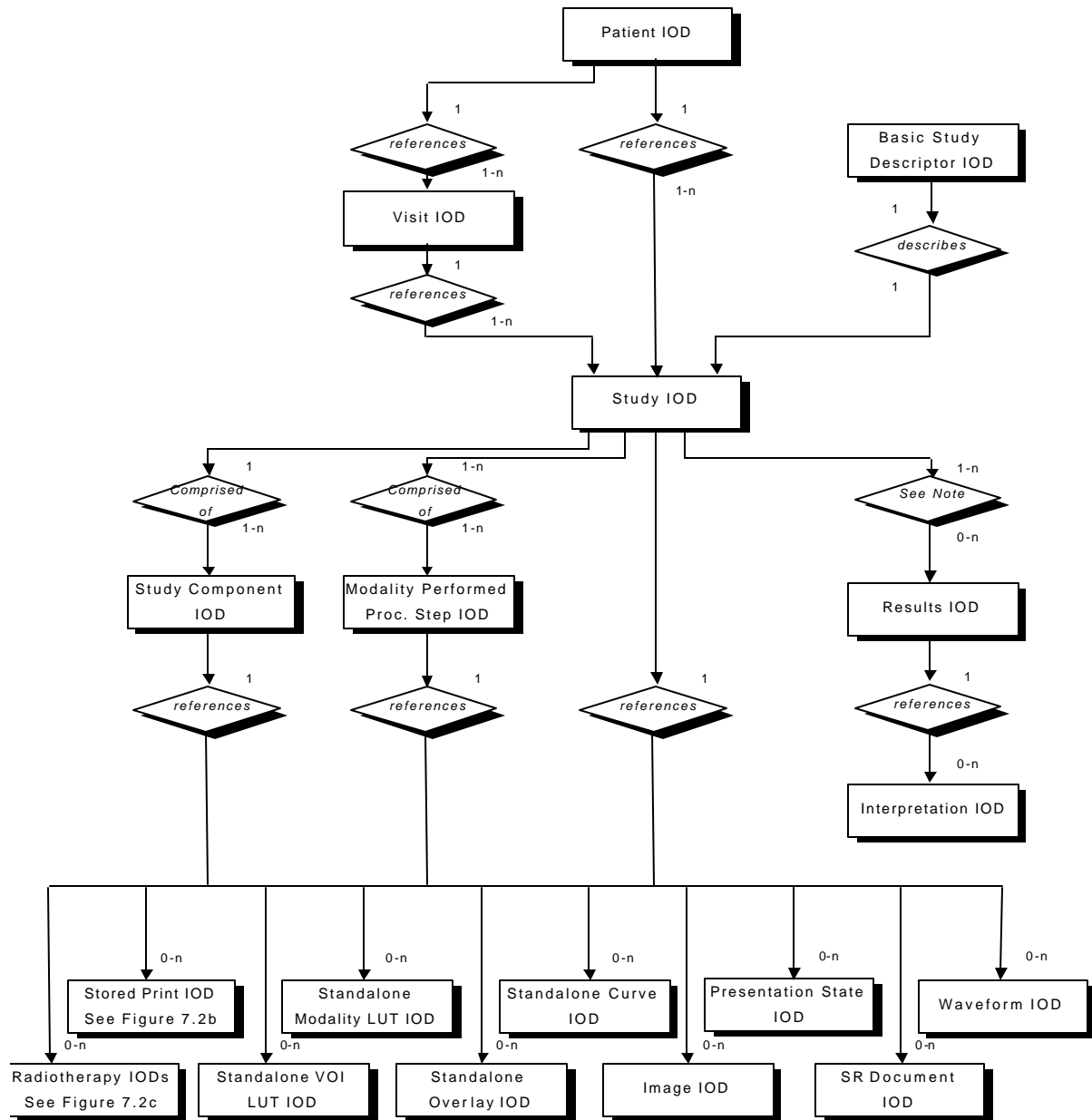

Figure 7-2a
DICOM INFORMATION MODEL

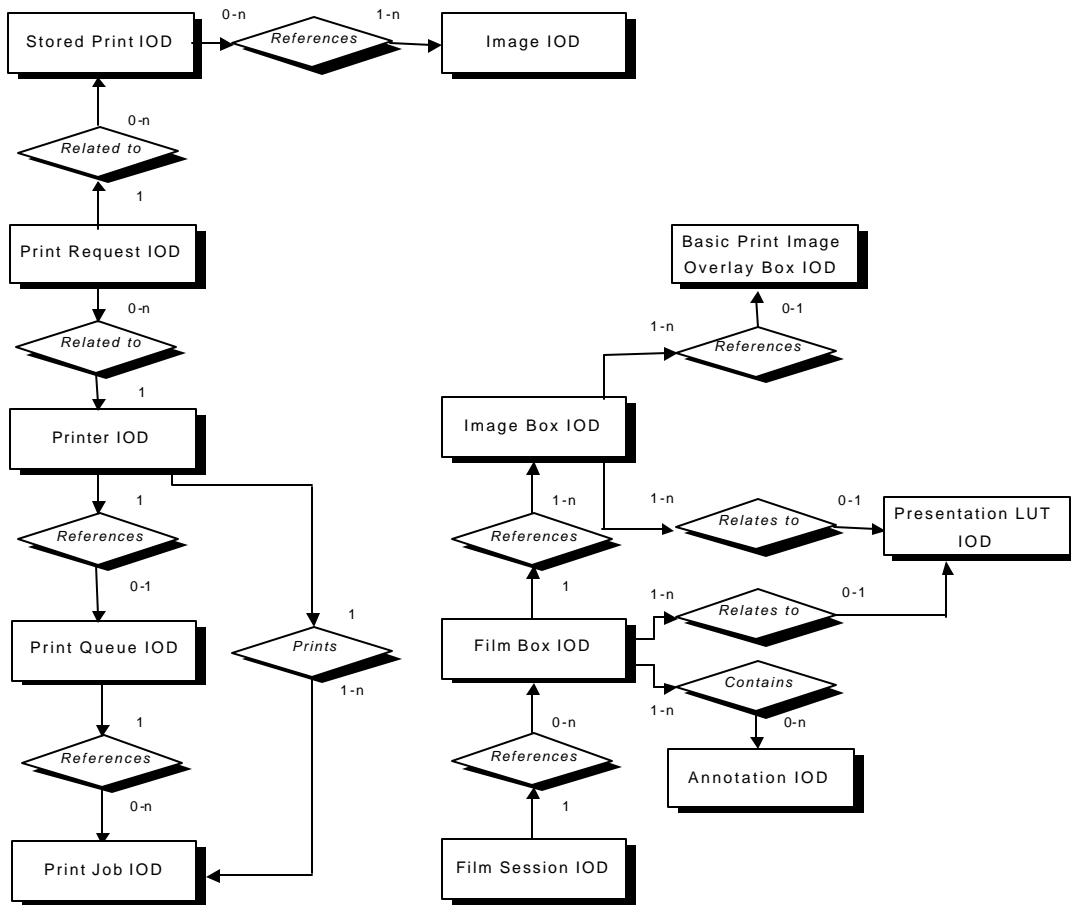

Figure 7-2b
DICOM INFORMATION MODEL - PRINT

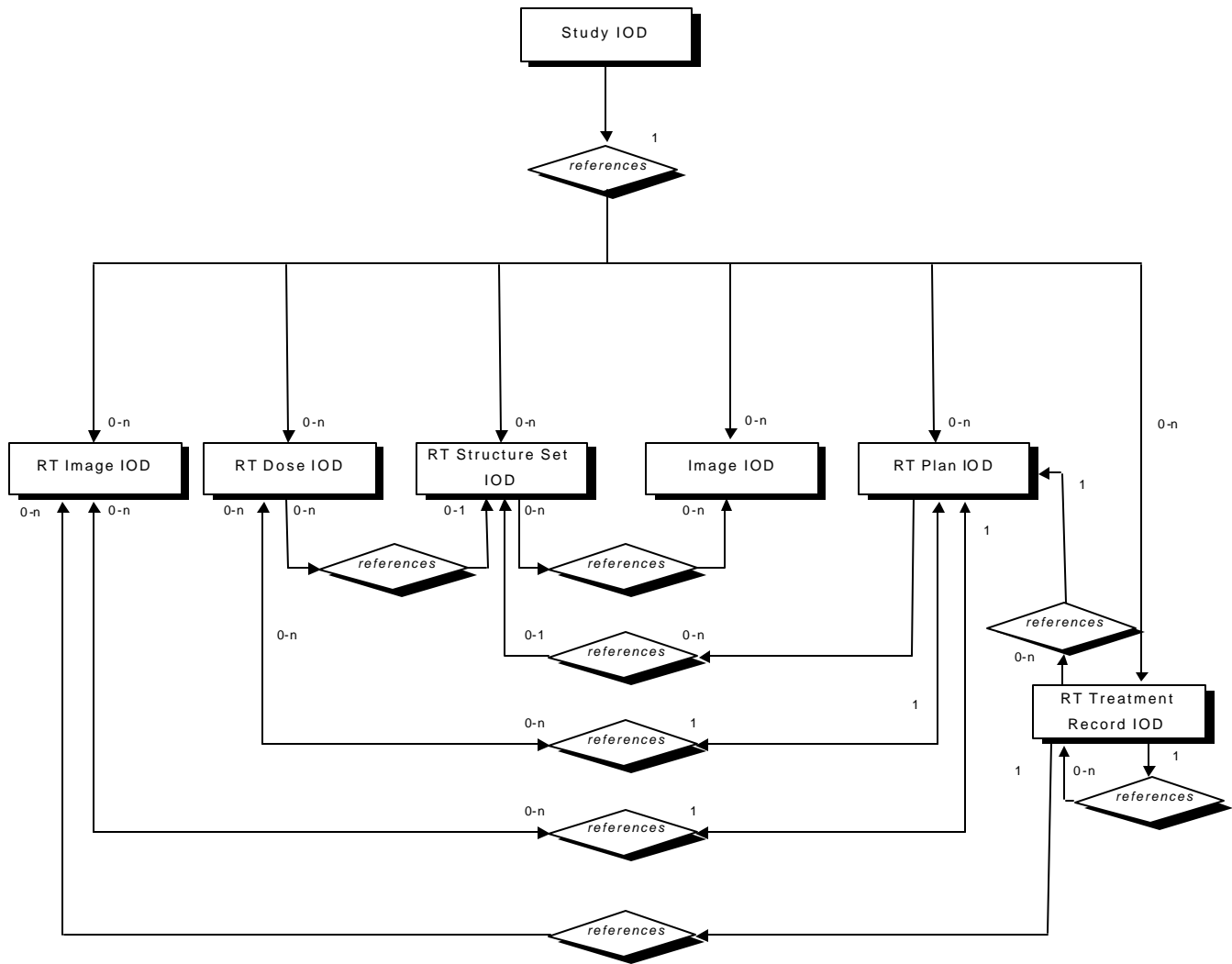

Figure 7-2c
DICOM INFORMATION MODEL - RADIOTHERAPY

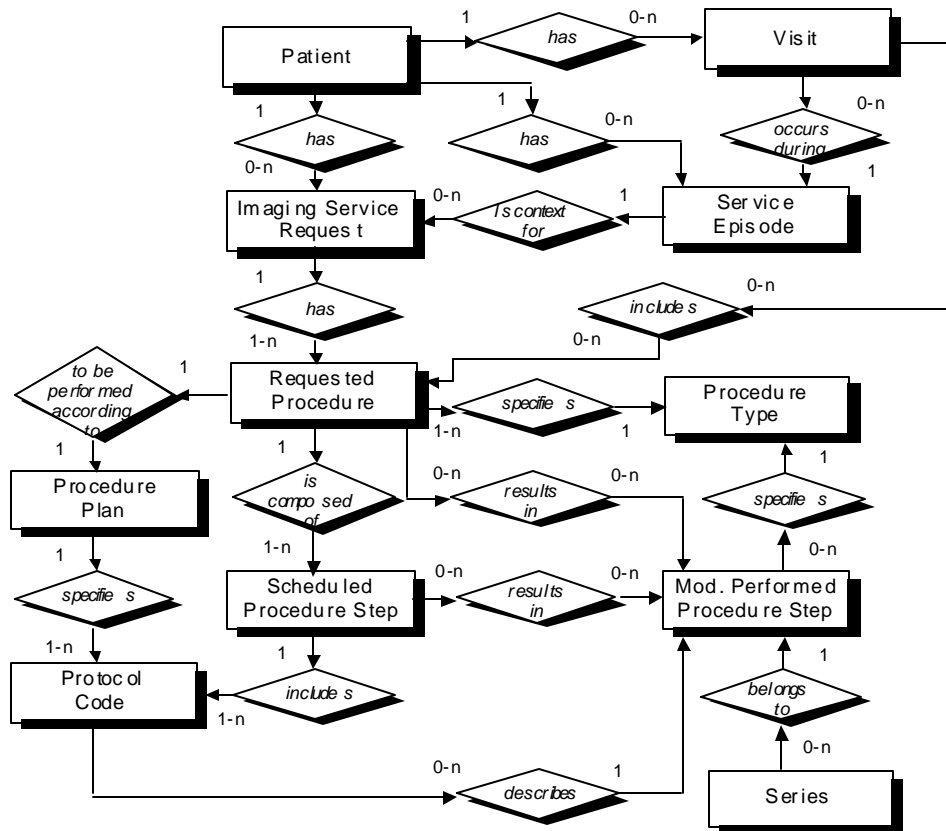

Figure 7-3.
MODEL OF THE REAL WORLD FOR THE PURPOSE OF MODALITY-IS INTERFACE

7.1 DICOM INFORMATION MODEL

The DICOM Information Model is derived from the DICOM Model of the Real-World. The DICOM Information Model presented by Figures 7-2a, 7-2b and 7-2c identify the various IODs specified by this Standard and their relationships. There is not always a one-to-one correspondence between DICOM Information Object Definitions and Real-World Objects. For example a Composite IOD contains Attributes of multiple real-world objects such as series, equipment, frame of reference, study and patient.

The entities in Figures 7-2a, 7-2b and 7-2c correspond to IODs defined in Annexes A through C.

7.2 ORGANIZATION OF ANNEXES A, B AND C

Annex A defines Composite IOD's (e.g. Images, Curves, Overlays) acquired on a number of Modalities (e.g. CT, MR, NM, US, CR, Secondary Capture). These Composite IOD's reference Modules found in Annex C.

Annex B defines Normalized IODs (e.g. Patient, Study, Results, Film Session, Print Job) for a number of Service Classes specified in PS 3.4. These Normalized IODs reference Module definitions found in Annex C.

7.3 EXTENSION OF THE DICOM MODEL OF THE REAL-WORLD

For the purpose of the Basic Worklist Management Service Class and the Modality Performed Procedure Step SOP Classes an enhancement of the original DICOM Model of the Real-World is made, as depicted in Figure 7-3.

Annex G discusses the relationship of this extension to the original DICOM model of the real world.

Figure 7-3 is an abstract description of the real world objects invoked in the Modality-IS Interface. It is not to be seen as a database scheme for an implementation.

Note: The real world model depicted in Figure 7.3 is influenced by the ISIS (Information System - Imaging System) Model. The ISIS Model is being developed by the DICOM Committee, the College of American Pathologists Image Exchange Committee (CAP-IEC), CEN/TC251/WG4/PT4-020: Modality-Information System Interface Project Team, and Health Level Seven (HL7) as the Real World Model for the domain of the Information System - Imaging System interface. The ISIS model is a common mapping of CEN/TC251/WG3/PT-022, CEN/TC251/WG4/PT-020, HL7, CAP-IEC, and ACR-NEMA DICOM Real-World-Models. The semantics of the objects and their attributes in this Standard are described in the ISIS model. This supplement uses only the subset of the ISIS Model that contains objects relevant to the Worklist. The ISIS Model ensures consistency with PT-022, CAP-IEC, and HL7.

7.3.1 Definition of the Extensions of the DICOM Real-World Model

7.3.1.1 PATIENT

A Patient is a person receiving, or registered to receive, healthcare services.

7.3.1.2 SERVICE EPISODE

A Service Episode is a collection of events, aggregated during an interval bounded by start and stop times (e.g. an outpatient visit or a hospitalization). The definition of the start time, stop time, and included events of a Service Episode is entirely arbitrary. A Service Episode is the context in which the treatment or management of an arbitrary subset of a Patient's medical conditions occurs. In the context of imaging services, a Service Episode may involve one or more Healthcare Organizations (administrative entities that authorize Healthcare Providers to provide services within their legal administrative domain, e.g. hospitals, private physician's offices, multispecialty clinics, nursing homes). A subset of Service Episode, the Facility Episode, is the collection of events that fall under the accountability of a particular Healthcare Organization. A Service Episode identifies the Certified Health Care Providers who have been delegated responsibility by one or more Healthcare Organizations to provide healthcare services to the Patient. One or more Certified Healthcare Providers (Organizations or individual persons, e.g. physician group practices, individual physicians, technologists, nurses) may be accountable for the healthcare services provided in a Service Episode. The Certified Health Care Providers are accountable to one or more Healthcare Organizations and to the Patient for the outcomes of the services provided. A Service Episode may be associated with one or more physical locations (e.g. different rooms, departments, buildings, or cities). One or more DICOM Visits may be associated with a Service Episode.

Notes: 1. The Service Episode is defined both in the ISIS model and in this extension of the DICOM model of the real world, to ensure consistency with PT3-022, CAP-IEC and HL7. The DICOM Visit is a part of the Service Episode. The Service Episode describes several administrative aspects of healthcare, while the DICOM Visit is limited to the description of one visit of a Patient to a facility.
2. In the context of the Modality Worklist SOP Class, only the DICOM Visit is of relevance, the Service Episode Modules are not defined.

7.3.1.3 IMAGING SERVICE REQUEST

An Imaging Service Request is a set of one or more Requested Procedures selected from a list of Procedure Types. An Imaging Service Request is submitted by one authorized imaging service requester to one authorized imaging service provider in the context of one Service Episode. An Imaging Service Request includes pertinent specific and general information. Each instance of an Imaging Service Request carries the information common to one or more Requested Procedures requested at the same moment. An Imaging Service Request may be associated with one or more DICOM Visits. The existence of an Imaging Service Request will typically result in the creation of one or more Imaging Service Reports and the distribution of Imaging Service Reports to one or more destinations.

In the context of the Modality Worklist the information provided by the Imaging Service Request aims at performing one or more imaging procedures, i.e. at acquiring new images. In the context of the General Purpose Worklist the information provided by the Imaging Service Request supports a more general kind of request, e.g. reporting, requesting an image processing procedure on an existing examination, etc.

7.3.1.4 PROCEDURE TYPE

A Procedure Type identifies a class of procedures. In the context of imaging services, a Procedure Type is an item in a catalog of imaging procedures that can be requested and reported upon in an imaging service facility. An instance of a Procedure Type typically has a name and one or more other identifiers. A Procedure Type is associated with one or more Procedure Plans.

Note: The information content of this entity relates to the general identification of a Procedure Type rather than to its decomposition into the protocol(s) required to perform a specific instance of a Requested Procedure for a particular Patient.

7.3.1.5 REQUESTED PROCEDURE

A Requested Procedure is an instance of a Procedure of a given Procedure Type. An instance of a Requested Procedure includes all of the items of information that are specified by an instance of a Procedure Plan that is selected for the Requested Procedure by the imaging service provider. This Procedure Plan is defined by the imaging service provider on the basis of the Procedure Plan templates associated with the considered Procedure Type. An Imaging Service Request may include requests for several different Requested Procedures. The purpose of this entity is to establish the association between Imaging Service Requests and Procedure Types, to convey the information that belongs to this association and to establish the relationships between Requested Procedures and the other entities that are needed to describe them. A single Requested Procedure of one Procedure Type is the smallest unit of service that can be requested, reported, coded and billed. Performance of one instance of a Requested Procedure is specified by exactly one Procedure Plan. A Requested Procedure leads to one or more Scheduled Procedure Steps involving Protocols as specified by a Procedure Plan. A Requested Procedure may be associated with one or more DICOM Visits. A Requested Procedure may involve one or more pieces of equipment.

7.3.1.6 SCHEDULED PROCEDURE STEP

A Modality Scheduled Procedure Step is an arbitrarily defined scheduled unit of service, that is specified by the Procedure Plan for a Requested Procedure. A Modality Scheduled Procedure Step prescribes Protocol which may be identified by one or more protocol codes. A Modality Scheduled Procedure Step involves equipment (e.g. imaging Modality equipment, anesthesia equipment, surgical equipment, transportation equipment), human resources, consumable supplies, location, and time (e.g. start time, stop time, duration). While in the context of imaging services the scheduling of a Modality Scheduled Procedure Step might include only a general designation of imaging Modality that could be satisfied by multiple pieces of the same equipment type, the performance of one instance of a Modality Scheduled Procedure Step involves one and only one piece of imaging Modality equipment.

The performance of a Modality Scheduled Procedure Step may result in the creation of zero or more Modality Performed Procedure Step instances.

- Notes:
1. The Procedure Step entity is provided to support management of the logistical aspects of procedures (e.g. materials management, human resources, scheduling). The full definition of the contents of Procedure Steps and protocols according to which they are performed is implementation dependent and is beyond the scope of this Standard.
 2. A Modality Scheduled Procedure Step may contribute to more than one Requested Procedure (e.g. a Modality Scheduled Procedure Step requiring an intravenous iodine contrast injection might be shared by an intravenous pyelogram and a CT examination). However, for billing purposes an instance of a Modality Scheduled Procedure Step is typically considered to be a part of only one Requested Procedure.

7.3.1.7 PROCEDURE PLAN

A Procedure Plan is a specification that defines the set of Protocols that must be done in order to perform the Scheduled Procedure Steps of a Requested Procedure. Each Scheduled Procedure Step is performed according to a single Protocol which may be identified by one or more Protocol Codes. The Protocols actually performed during a Procedure Step may differ from those prescribed in the related Procedure Plan. Audit of actually performed Protocols versus the prescribed Procedure Plan is an important element of quality control, but is not specified by this Standard.

Note: The fact that Protocol Codes are in a given order in a Procedure Plan is not evident in Figure 7.3. However, the order of Protocols is represented at the syntax level (i.e. as the sequence of items present in the Protocol Code Sequence (0040,0008)).

7.3.1.8 PROTOCOL

A Protocol is a specification of actions prescribed by a Procedure Plan to perform a specific Procedure Step. A Scheduled Procedure Step contains only one Protocol which may be conveyed by one or more Protocol Codes. Typically, the code or codes identifying a Protocol instance would be selected from a catalog of protocols. Multiple Protocols may not exist in one Scheduled Procedure Step.

7.3.1.9 MODALITY PERFORMED PROCEDURE STEP

A Performed Procedure Step is an arbitrarily defined unit of service that has actually been performed (not just scheduled). Logically it corresponds to a Scheduled Procedure Step, but real-world conditions may dictate that what is actually performed does not correspond exactly with what was requested or scheduled.

Note: For example, two or more Scheduled Procedure Steps, Requested Procedures or Imaging Service Requests may have been generated by different Referring Physicians but may be satisfied by a single Performed Procedure Step at the discretion of a Performing Physician or Operator. Alternatively, a single Scheduled Procedure Step may need to be satisfied by multiple Performed Procedure Steps on different types or instances of equipment, due to clinical need or failure conditions, or over extended periods of time.

It contains information describing the type of procedure actually performed. This information is represented by the Performed Protocol that may be defined by one or more Protocol Codes.

A Requested Procedure results in the creation of zero or more Performed Procedure Steps.

A Scheduled Procedure Step results in the creation of zero or more Performed Procedure Steps.

The Performed Procedure Step contains information about its state (e.g. in progress, discontinued or completed).

A Modality Performed Procedure Step is a Performed Procedure Step that results from the acquisition of images from a Patient or other Imaging Subject on a Modality.

It contains information describing the performance of a step of an imaging procedure, including data about the performance of the procedure itself, radiation dose values to which the patient has been exposed if ionizing radiation is in use, and data for billing and material management.

The Modality Performed Procedure Step contains references to zero or more Series of Images and other Composite SOP Instances that may be created as part of the procedure step. A particular Series is part of only one Modality Performed Procedure Step.

7.3.1.10 GENERAL PURPOSE SCHEDULED PROCEDURE STEP

A General Purpose Scheduled Procedure Step is an arbitrarily defined scheduled unit of service, that is specified by the Procedure Plans of one or more Requested Procedures. A General Purpose Scheduled Procedure Step prescribes one Workitem that describes the procedure step to be performed. A General Purpose Scheduled Procedure Step involves applications, human resources, location, and time resources (e.g. start time, stop time, duration).

- Notes:
1. In this section, application is the generic term used to designate software applications and pieces of devices.
 2. The status of a general Purpose Scheduled Procedure Step must not be confused with the status of the Requested Procedure or Imaging Service Request to which it belongs. One General Purpose Scheduled Procedure Step may be completed, but that does not imply that also the related Requested Procedure has reached its completion.

A General Purpose Scheduled Procedure Step contains references to Composite SOP Instances or Performed Procedure Steps, which denote the information to be used for the performance of the General Purpose Scheduled Procedure Step.

7.3.1.11 GENERAL PURPOSE PERFORMED PROCEDURE STEP

A general Purpose Performed Procedure step is an arbitrarily defined unit of service that has actually been performed (not just scheduled). Normally it corresponds to one General Purpose Scheduled Procedure step, but real-world conditions may dictate that what is actually performed does not correspond exactly with what was requested or scheduled.

- Note:
- For example, two or more General Purpose Scheduled Procedure Steps, Requested Procedures or Imaging Service Requests may have been generated by different Referring Physicians but may be satisfied by a single General Purpose Performed Procedure Step at the discretion of a Performing Physician or Operator. Alternatively, a single General Purpose Scheduled Procedure step may need to be satisfied by multiple General Purpose Performed Procedure Steps on different types or instances of equipment, due to clinical need or failure conditions, or over extended periods of time.

It contains information describing the type of procedure actually performed.

A Requested Procedure results in the creation of zero or more General Purpose Performed Procedure Steps.

A General Purpose Scheduled Procedure Step results in the creation of zero or more General Purpose Performed Procedure Steps.

The General Purpose Performed Procedure Step contains information about its state.

It contains information describing the performance of the general purpose procedure step of a procedure.

The General Purpose Performed Procedure step contains references to zero or more Composite SOP Instances that have been created as part of the procedure step.

7.3.1.12 WORKITEM

A Workitem is one of the tasks prescribed by a Procedure Plan to perform an instance of a Requested Procedure. Each General Purpose Scheduled Procedure Step will contain exactly one Workitem. The code identifying a Workitem instance would be selected from a catalog of workitem types, for example with the value of Image Processing or Interpretation.

7.4 EXTENSION OF THE DICOM MODEL OF THE REAL-WORLD FOR THE GENERAL PURPOSE WORKLIST

For the purpose of the General Purpose Worklist SOP Class in the Worklist Management Service Class an extension of the DICOM Model of the Real-World is made, as depicted in Figures 7.4.a and 7.4.b.

This subset of the real-world model covers the requirements for the General Purpose Worklist SOP Class in the Worklist Management Service Class.

Figures 7.4.a and 7.4.b are an abstract description of the real world objects involved in Workflow Management.

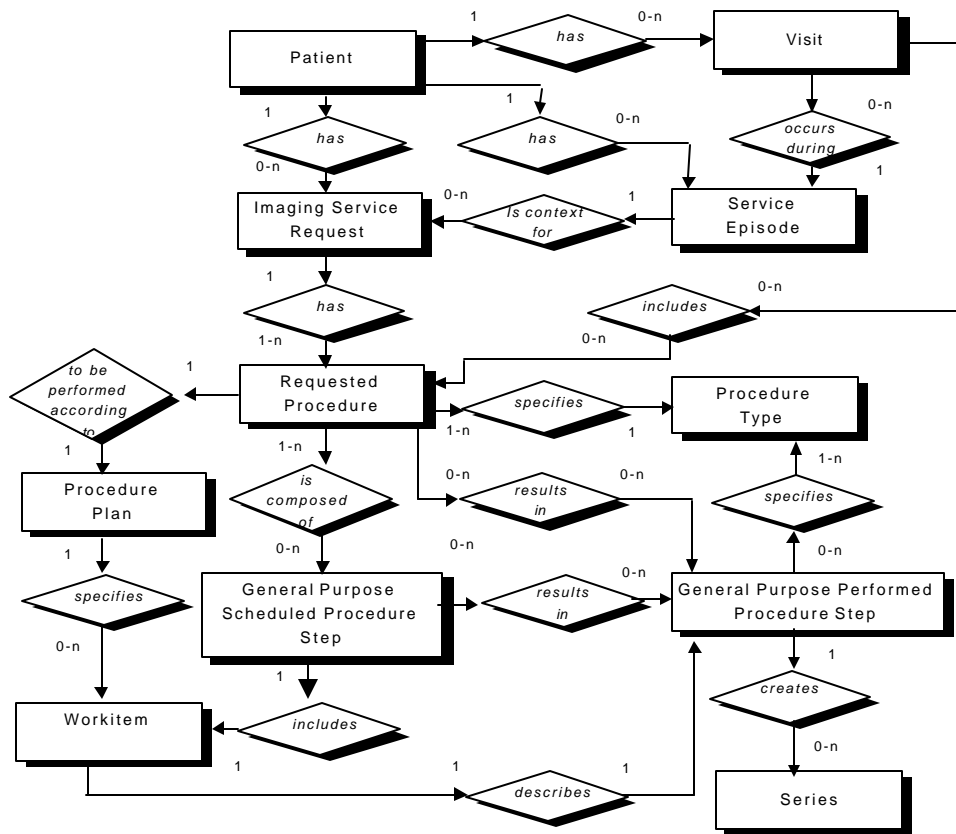

Figure 7.4.a
Model of the real world for the purpose of General Purpose Worklist interface

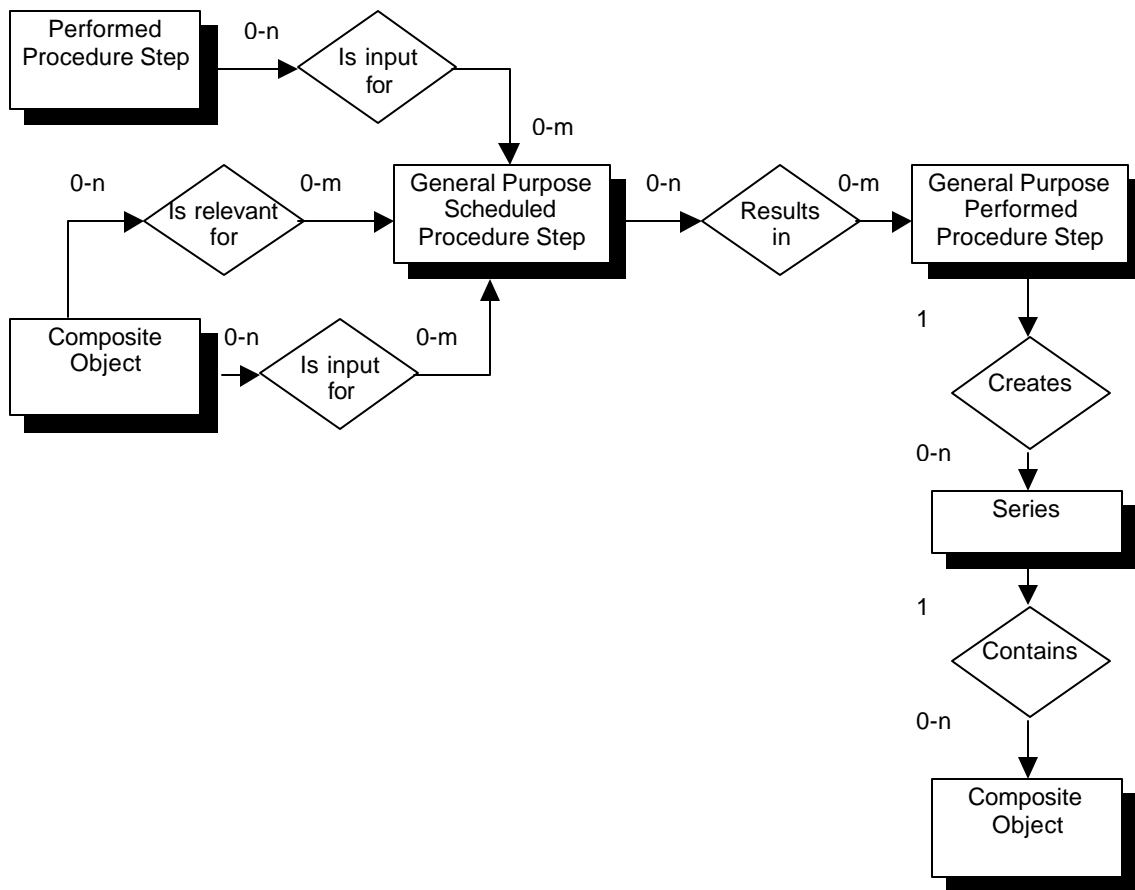

Figure 7.4.b
Model of the real world for the purpose of General Purpose Worklist interface

8 Encoding of Coded Entry Data

The primary method of incorporating coded entry data in DICOM IODs is the Code Sequence Attribute. Code Sequence Attributes are encoded as a Sequence of Items using a macro which is described in this section. These Attributes typically include the string "Code Sequence" in the Attribute Name. Their purpose is to encode terms by using codes from coding schemes.

Note: In this Standard, Code Sequence Attributes are defined for a variety of concepts, for example: Primary Anatomic Structure Sequence (0008,2228) and other Attributes to describe anatomy; and Interventional Drug Code Sequence (0018,0029), to document administration of drugs that have special significance in Imaging Procedures.

Each Item of a Code Sequence Attribute contains the triplet of Coding Scheme Designator, the Code Value, and Code Meaning. Other optional and conditional attributes may also be present.

For any particular Code Sequence Attributes, the range of codes that may be used for that attribute (the Value Set) may be suggested or constrained by specification of a Context Group. The Module or Template in which the attribute is used will specify whether or not the context group is baseline, defined or enumerated. A Baseline Context Group lists codes for terms which are suggested and may be used, but are not required to be used. A Defined Context Group lists codes for terms which shall be used if the term is used, but which may be extended with codes for other terms. An Enumerated Context Group lists codes for terms that shall be used, and no other codes or terms shall be used.

Context Groups are defined in a Mapping Resource, such as the DICOM Content Mapping Resource (DCMR) specified in PS 3.16. Context Groups consist of lists of terms, including the Code Value (0008,0100) and Coding Scheme Designator (0008,0102). Whether a Context Group is used as a Baseline, Defined or Enumerated Context Group is defined not in the mapping resource, but rather in the Template or Module in which the Code Sequence Attribute is used.

Context Groups are identified by labels referred to as Context Group Identifiers (CID).

8.1 CODE VALUE

The Code Value (0008,0100) is an identifier that is unambiguous within the Coding Scheme denoted by Coding Scheme Designator (0008,0102) and Coding Scheme Version (0008,0103).

Note: The Code Value is typically not a natural language string, e.g. "T-04000".

8.2 CODING SCHEME DESIGNATOR, CODING SCHEME VERSION, AND PRIVATE CODING SCHEME CREATOR UID

The attribute Coding Scheme Designator (0008,0102) identifies the coding scheme in which the code for a term is defined.

- Notes:
1. Typical coding schemes used in DICOM include "DCM" for DICOM defined codes, "SNM3" for SNOMED version 3, "SRT" for SNOMED-RT, and "LN" for LOINC.
 2. Coding scheme designators beginning with "99" and the coding scheme designator "L" are defined in HL7 to be private or local coding schemes.

If the Coding Scheme Designator (0008,0102) is not sufficient to identify the coding scheme uniquely and unambiguously, additional attributes may be required.

The attribute Coding Scheme Version (0008,0103) may be used to identify the version of a coding scheme.

The attribute Private Coding Scheme Creator UID (0008,010C) may be used to more precisely identify a private (rather than a standard) coding scheme.

Standard coding schemes are those that are listed in PS 3.16. That context group is based on a similar list in the HL7 and ASTM 2538 standards.

In previous versions of the DICOM Standard, a provisional Coding Scheme Identifier of "99SDM" was used for SNOMED codes that were used in DICOM.

Consequently, when a Coding Scheme Designator (0008,0102) of "99SDM" is encountered, it shall be treated as equivalent to "SNM3" for the purpose of interpreting Code Value (0008,0100).

A Coding Scheme Designator (0008,0102) of "99SDM" or "SNM3" is defined to identify the SNOMED Version 3 Coding Scheme unambiguously, hence the condition for inclusion of Coding Scheme Version (0008,0103) is explicitly not satisfied.

8.3 CODE MEANING

The Code Meaning (0008,0104) is text which has meaning to a human and which conveys the meaning of the term defined by the combination of Code Value and Coding Scheme Designator. Though such a meaning can be "looked up" in the dictionary for the coding scheme, it is encoded for the convenience of applications that do not have access to such a dictionary.

It should be noted that for a particular Coding Scheme Designator (0008,0102) and Code Value (0008,0100), several alternative values for Code Meaning (0008,0104) may be defined. These may be synonyms in the same language or translations of the Coding Scheme into other languages. Hence the value of Code Meaning (0008,0104) shall never be used as a key, index or decision value, rather the combination of Coding Scheme Designator (0008,0102) and Code Value (0008,0100) may be used. Code Meaning (0008,0104) is a purely annotative, descriptive Attribute.

This does not imply that Code Meaning (0008,0104) can be filled with arbitrary free text. Only values defined by the Coding Scheme shall be used.

8.4 MAPPING RESOURCE

The value of Mapping Resource (0008,0105) denotes the message/terminology Mapping Resource that specifies the Context Group that specifies the Value Set. The Defined Terms for the value of Mapping Resource (0008,0105) shall be:

"DCMR"= "DICOM Content Mapping Resource",
"SDM"= "SNOMED DICOM Microglossary" (Retired).

PS 3.16 specifies the DICOM Content Mapping Resource (DCMR).

Note: Unless otherwise specified, the DCMR is the source of all Context Groups and Templates specified in this Standard.

8.5 CONTEXT GROUP VERSION

Context Group Version (0008,0106) conveys the version of the Context Group identified by Context Identifier (0008,010F).

8.6 CONTEXT IDENTIFIER

The value of Context Identifier (0008,010F) identifies the Context Group defined by Mapping Resource (0008,0105) from which the values of Code Value (0008,0100) and Code Meaning (0008,0104) were selected or the Context Group defined by Mapping Resource (0008,0105) to which the Code Value (0008,0100) and Code Meaning (0008,0104) have been added as a private Context Group extension by Context Group Creator UID (0008,010E).

8.7 CODE SET EXTENSIONS

Code Set Extension Flag (0008,010B) may be used to designate a Code Value/Code Meaning pair as a private extension of a Coding Scheme or Context Group. Code Set Extension Creator UID (0008,010D) may be used to identify the person or organization who created an extension to a Context Group and/or Coding Scheme. Context Group Local Version (0008,0107) conveys an implementation-specific private version date/time of a Context Group that contains private code set extensions. See Section 8.8 of this Part for further definition.

- Notes:
1. These Attributes provide the means for users to extend code sets conveniently, while preserving referential integrity with respect to the original Context Group Version. These attributes also enable system administrators to track extensions so that they can be submitted to standards bodies as change proposals for controlled terminologies.
 2. The locally-defined (private) value of Context Group Local Version (0008,0107) typically would be a more recent date than the standard value of Context Group Version (0008,0106) specified in the standard message/terminology Mapping Resource that defines the Context Group.

8.8 STANDARD ATTRIBUTE SETS FOR CODE SEQUENCE ATTRIBUTES

Table 8.8-1 specifies the default set of Attributes encapsulated in the Items of Code Sequence Attributes. These Attributes comprise the Code Sequence Macro.

- Note: The instruction “*Include ‘Code Sequence Macro’ Table 8.8-1*” may be used in an Information Object Definition as a concise way to indicate that the attributes of Table 8.8-1 are included in the specification of the Attribute Set of a Sequence of items. Additional constraints on the Code Sequence Data Element (such as a Context Group that defines the value set) may be appended to the “*Include ‘Code Sequence Macro’ Table 8.8-1*” instruction.

The default specifications of this Section are overridden within the scope of a Sequence Item or Code Sequence Attribute or IOD by corresponding specifications defined within the scope of that Sequence Item or Code Sequence Attribute or IOD. Additional Attributes may also be specified by the instantiation of the macro.

The Basic Coded Entry Attributes fully define a Coded Entry. If it is desired to convey the list from which a code has been chosen, then the optional Enhanced Encoding Mode Attributes may also be sent.

**Table 8.8-1 Common Attribute Set for Code Sequence Attributes
(Invoked as "Code Sequence Macro")**

Attribute Name	Tag	Type	Attribute Description
<i>BASIC CODED ENTRY ATTRIBUTES</i>			
Code Value	(0008,0100)	1C	See Section 8.1. Required if a sequence item is present.
Coding Scheme Designator	(0008,0102)	1C	See Section 8.2. Required if a sequence item is present.
Coding Scheme Version	(0008,0103)	1C	See Section 8.2. Required if a sequence item is present and the value of Coding Scheme Designator (0008,0102) is not sufficient to identify the Code Value (0008,0100) unambiguously.
Code Meaning	(0008,0104)	1C	See Section 8.3. Required if a sequence item is present.
<i>ENHANCED ENCODING MODE</i>			
Context Identifier	(0008,010F)	3	See Section 8.6.
Mapping Resource	(0008,0105)	1C	See Section 8.4. Required if Context Identifier (0008,010F) is present.
Context Group Version	(0008,0106)	1C	See Section 8.5. Required if Context Identifier (0008,010F) is present.
Code Set Extension Flag	(0008,010B)	3	Code Set Extension Flag (0008,010B) indicates whether the Code Value/Code Meaning pair encoded in Code Value (0008,0100) and Code Meaning (0008,0104) is a private extension of a Context Group and/or Coding Scheme. See Section 8.7 of this Part. Enumerated Values: "Y", "N" If Context Identifier (0008,010F) is present, then "Y" shall mean "The Code Value/Code Meaning pair is a private extension of the Context Group designated by Context Identifier (0008,010F)." If no value of Context Identifier (0008,010F) is present, then "Y" shall mean "The Code Value/Code Meaning pair is a private extension of the Coding Scheme designated by Coding Scheme Designator (0008,0102) and Coding Scheme Version (0008,0103)."
Context Group Local Version	(0008,0107)	1C	See Section 8.7. Required if the value of Code Set Extension Flag (0008,010B) is "Y". May also be present if the Context Group denoted by Context Identifier (0008,010F) contains private code set extensions.
Private Coding Scheme Creator UID	(0008,010C)	3	Private Coding Scheme Creator UID (0008,010C) identifies the organization that created and/or maintains the private Coding Scheme used, if any. See Section 8.2.
Code Set Extension Creator UID	(0008,010D)	1C	Code Set Extension Creator UID (0008,010D) identifies the person or organization who created an extension to a Coding Scheme or Context Group. See Section 8.7. Required if the value of Code Set Extension Flag (0008,010B) is "Y".

9 TEMPLATE IDENTIFICATION MACRO

A Template for SR Documents defines a set of constraints on the relationships and content (Value Types, Codes, etc.) of Content Items that reference such a Template. Specific Templates for SR Documents are defined either by the DICOM Standard or by users of the Standard for particular purposes.

The presence of a referenced Template reflects that the referenced Template was used in the creation of the associated Content Item. The use by the SR Storage SCP of Templates is beyond the scope of the DICOM Standard. Usage of Templates for SR Documents may improve comparability of essential data, facilitate data-entry and revisions, enable automatic processing and simplify presentation of information to the user.

Table 9-1 specifies the set of Attributes that identify Templates. These Attributes comprise the Template Macro. Attribute Descriptions in Table 9-1 refer to similar attributes of the Code Sequence Macro in Section 8.8 of this Part.

Table 9-1
Template Identification Macro Attributes Description

Attribute Name	Tag	Type	Attribute Description
Template Identifier	(0040,DB00)	1	Template identifier.
Mapping Resource	(0008,0105)	1	Mapping Resource that defines the template. See Section 8.4.
Template Version	(0040,DB06)	1C	Version of the Template. See Section 8.5. Required if the Template Identifier (0040,DB00) and Mapping Resource (0008,0105) are not sufficient to identify the template unambiguously.
Template Local Version	(0040,DB07)	1C	Local version number assigned to a template that contains private extensions. See Section 8.7. Required if the value of Template Extension Flag (0040,DB0B) is "Y".
Template Extension Flag	(0040,DB0B)	1C	Indicates that the template is a private extension of the template denoted by Template Identifier (0040,DB00), Mapping Resource (0008,0105) and Template Version (0040,DB06). See Section 8.7 of this Part. Enumerated Values: Y, N "Y" shall mean the template is a private extension of the template designated by Template Identifier (0040,DB00), Mapping Resource (0008,0105) and Template Version (0040,DB06). Required if the template is a private extension of the template designated by Template Identifier (0040,DB00), Mapping Resource (0008,0105) and Template Version (0040,DB06).

Template Extension Organization UID	(0040,DB0C)	2C	Identifies the organization that created and/or maintains an extension to a template, if defined. See Section 8.7. Required if the value of Template Extension Flag (0040,DB0B) is "Y".
Template Extension Creator UID	(0040,DB0D)	2C	Identifies the person who created and/or maintains an extension to a template. See Section 8.7. Required if the value of Template Extension Flag (0040,DB0B) is "Y".

Annex A Composite information object definitions (Normative)

A.1 ELEMENTS OF AN INFORMATION OBJECT DEFINITION

Each Composite Information Object Definition is composed of the following Sections

- a. IOD Description
- b. IOD Entity-Relationship Model
- c. IOD Module Table

Sections A.1.1 through A.1.3 of this document define the requirements of a) through c) above.

A.1.1 IOD Description

This Section provides a brief description of the IOD. Specifically, this description includes:

- The Real-World Object which is represented by the IOD
- Information as to the scope of the represented object if appropriate

A.1.2 IOD Entity-Relationship Model

This Section of an IOD provides the Entity-Relationship (E-R) Model which depicts the relationships of the components or Information Entities (IE) of the specified IOD. It forms an IOD specific information model. This E-R model provides the complete context of how the composite instance information shall be interpreted when a composite instance is exchanged between two DICOM Application Entities.

Even though composite instances are sent as discrete individual components, each Composite Instance IOD E-R Model requires that all composite instances which are part of a specific study shall share the same context. That is, all composite instances within a specific patient study share the same patient and study information; all composite instances within the same series share the same series information; etc.

Figure A.1-1 is the DICOM Composite Instance IOD Information Model. It applies to all of the Composite Instance IODs defined in Annex A. However, a subset of this model may be specified by each individual Composite Instance IOD to accurately define the context for specific composite instance exchange.

Sections A.1.2.1 through A.1.2.10 describe the Information Entities (IE) which comprise the Composite Instance IODs defined in this Annex.

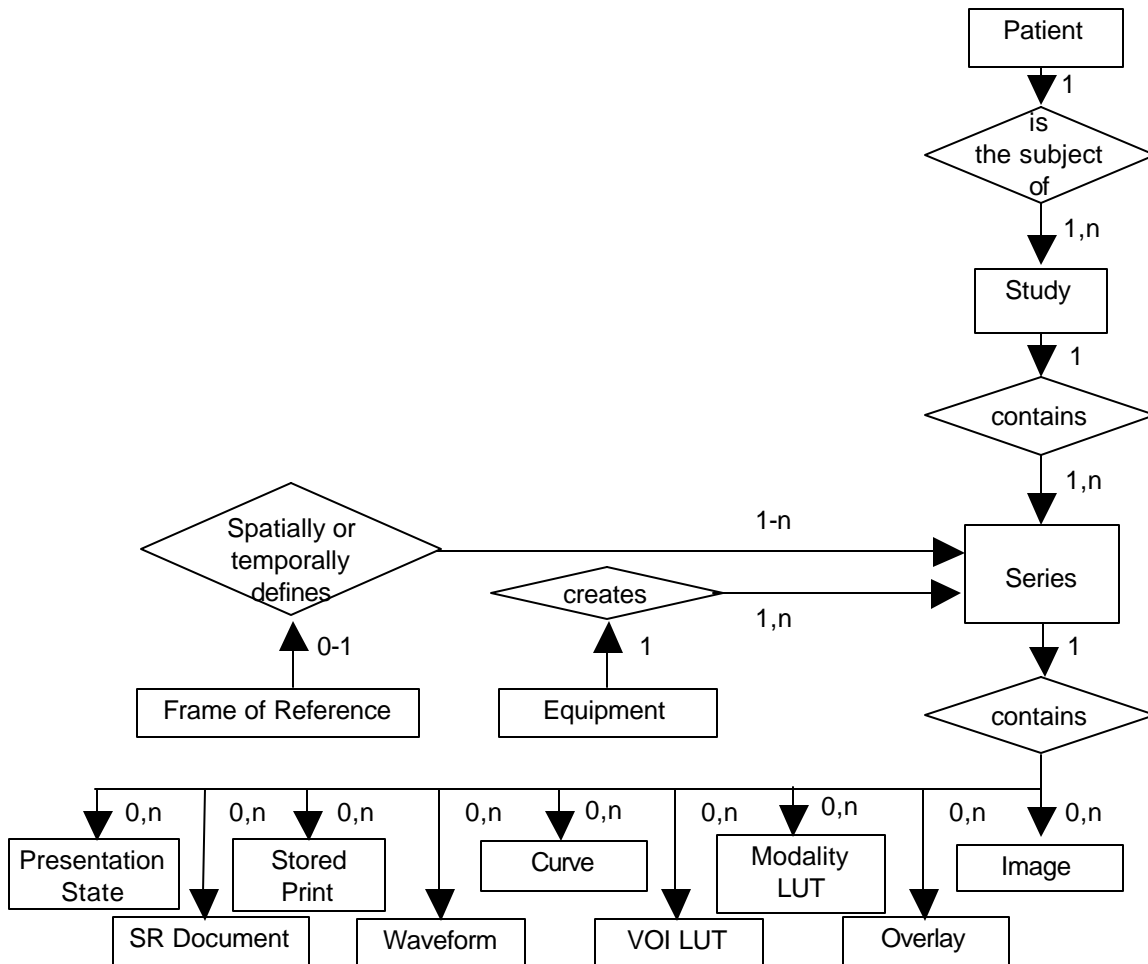

**Figure A.1-1
DICOM COMPOSITE INSTANCE IOD INFORMATION MODEL**

Each Series shall contain at least one Curve IE, VOI Lookup Table IE, Overlay IE, Modality LUT IE, Stored Print IE, Presentation State IE, SR Document IE or Image IE.

A.1.2.1 PATIENT IE

The Patient IE defines the characteristics of a patient who is the subject of one or more medical studies which produce medical images.

The Patient IE is modality independent.

A.1.2.2 STUDY IE

The Study IE defines the characteristics of a medical study performed on a patient. A study is a collection of one or more series of medical images, presentation states, SR documents, overlays and/or curves which are logically related for the purpose of diagnosing a patient. Each study is associated with exactly one patient.

A study may include composite instances that are created by a single modality, multiple modalities or by multiple devices of the same modality.

The Study IE is modality independent.

A.1.2.3 SERIES IE

The Series IE defines the Attributes which are used to group composite instances into distinct logical sets. Each series is associated with exactly one Study.

The following criteria group composite instances into a specific series:

- a. All composite instances within a series must be of the same modality
- b. If a specific Composite Instance IOD specifies the support of a Frame of Reference IE, all composite instances within the series shall be spatially or temporally related to each other; therefore, each series is associated with exactly one Frame of Reference IE
- c. If a specific Composite Instance IOD specifies the support of the Equipment IE, all composite instances within the series shall be created by the same equipment; therefore, each series is associated with exactly one Equipment IE
- d. All composite instances within a series shall have the same series information

Overlays and Curves may be grouped into a Series with or without Images. The Equipment IE and Frame of Reference IE are irrelevant to the Overlay IE and Curve IE.

Presentation States shall be grouped into Series without Images (i.e. in a different Series from the Series containing the Images to which they refer). The Frame of Reference IE is irrelevant to the Presentation State IE.

Note: The Series containing Presentation States and the Series containing the Images to which they refer are both contained within the same Study.

Waveforms shall be grouped into Series without Images. A Frame of Reference IE may apply to both Waveform Series and Image Series.

SR Documents shall be grouped into Series without Images. The Frame of Reference IE does not apply to SR Document Series.

A.1.2.4 EQUIPMENT IE

The Equipment IE describes the particular device which produced the series of composite instances. A device may produce one or more series within a study. The Equipment IE does not describe the data acquisition or image creation Attributes used to generate the composite instances within a series. These Attributes are described in the composite instance specific IEs (e.g. the Image IE).

A.1.2.5 FRAME OF REFERENCE IE

The Frame of Reference IE identifies the coordinate system which conveys spatial and/or temporal information of composite instances in a series.

When present, a Frame of Reference IE may be related to one or more series. In this case, it provides the ability to spatially or temporally relate multiple series to each other.

A.1.2.6 IMAGE IE

The Image IE defines the Attributes which describe the pixel data of an image. The pixel data may be generated as a direct result of patient scanning (termed an Original Image) or the pixel data may be derived from the pixel data of one or more other images (termed a Derived Image). An image is defined by its image plane, pixel data characteristics, gray scale and/or color mapping characteristics, overlay planes and modality specific characteristics (acquisition parameters and image creation information).

An image is related to a single series within a single study.

The pixel data within an Image IE may be represented as a single frame of pixels or as multiple frames of pixel data. The frames of a Multi-frame image (a cine run or the slices of a volume) are sequentially ordered and share a number of common properties. A few Attributes may vary between frames (eg. -Time, Angular Displacement, Slice Increment). All common Image IE Attributes refer to the first frame of a multiple frame image.

Overlay, Lookup Table and Curve data may be included within an Image IE only if this information is directly associated with the image.

A.1.2.7 OVERLAY IE

The Overlay IE defines the Attributes which describe an independent set of Overlay Planes. The Overlay IE may represent in a bit-map format, graphics or text and is used to indicate such items as region of interest, reference marks and annotations. These Overlay Planes may or may not be coincident with an image. If the Overlay Plane is coincident with an image, sufficient information shall be available to allow an overlay to be presented at a display station superimposed on a particular image with which it is associated. An Overlay IE shall be related to only one Series IE.

An Overlay Plane may be represented as a single frame (when associated with a single frame image) or as multiple frames of overlay planes (when associated with a Multi-frame image).

- Notes:
1. Examples of independent overlay planes are:
 - a) line drawings which illustrate the equipment and patient setup prescribed
 - b) line drawings which represent anatomy, pointers and text
 - c) drawings showing the layout of images and text fields for filming formats
 2. The Overlay IE is similar in concept to the 'Graphics Data Set' defined by earlier versions of this Standard.

A.1.2.8 CURVE IE

A Curve is used to represent graphical data that can be specified as a series of connected points. Curve data may or may not be superimposed on a coincident image. An independent Curve, like an independent Overlay, can exist as would an image without any Pixel Data. Curves can be used to specify multi-dimensional graphs, regions of interest, and annotation. Curve Data is not compressed in any of the DICOM Standard Transfer Syntaxes specified in PS 3.5.

Each curve is specified as a series of connected points. One or more Curves shall be described by using one or more even numbered Repeating Groups (5000-501E,eeee) whose attributes are described in the Curve Module. The Type of Data (50xx,0020) contained in the Curve shall be specified. For independent Curves, the Curve Identification Module is used to identify the Curve.

A.1.2.9 MODALITY LUT IE

The Modality LUT IE defines the Attributes which describe the transformation of manufacturer dependent pixel values into pixel values which are manufacturer independent (e.g. Hounsfield units for CT, Optical Density for film digitizers, etc.). The Modality LUT may be contained within an image, or a presentation state which references an image, or as a Standalone Modality LUT which references an image. When the transformation is linear, the Modality LUT is described by Rescale Slope (0028,10530) and Rescale Intercept (0028,1052). When the transformation is non-linear, the Modality LUT is described by Modality LUT Sequence (0028,3000).

A.1.2.10 VOI LUT IE

The VOI LUT IE defines the Attributes which describe the transformation of the modality pixel values into pixel values which are meaningful for print, display, etc. This transformation is applied after any Modality LUT. The VOI LUT may be contained within an image, or a presentation state which references an image, or as a Standalone VOI LUT which references an image. When the transformation is linear, the VOI LUT is

described by the Window Center (0028,1050) and Window Width (0028,1051). When the transformation is non-linear, the VOI LUT is described by VOI LUT Sequence (0028,3010).

A.1.2.11 PRESENTATION STATE IE

The Presentation State IE defines how a referenced image (or images) will be presented (e.g. displayed) in a device independent grayscale space (i.e. in P-Values), and what graphical annotations and spatial and grayscale contrast transformations will be applied to the referenced image pixel data.

A.1.2.12 WAVEFORM IE

The Waveform IE represents a multi-channel time-based digitized waveform. The waveform consists of measurements of some physical qualities (e.g., electrical voltage, pressure, gas concentration, or sound), sampled at constant time intervals. The measured qualities may originate, for example, in any of the following sources:

- a. the anatomy of the patient,
- b. therapeutic equipment (e.g., a cardiac pacing signal or a radio frequency ablation signal),
- c. equipment for diagnostic synchronization (e.g., a clock or timing signal used between distinct devices),
- d. the physician's voice (e.g., a dictated report).

The sample data within a Waveform IE may represent one or more acquired channels. Several signal channels acquired at the same sampling rate can be multiplexed (by interleaving samples) in a single multiplex group. (See also Annex J.)

A.1.2.13 SR DOCUMENT IE

The SR Document IE defines the Attributes which describe the content of an SR Document. These include semantic context as well as Attributes related to document completion, verification and other characteristics. An SR Document SOP Instance is related to a single Series within a single Study.

A.1.3 IOD Module Table

This Section of each IOD defines in a tabular form the Modules comprising the IOD. The following information must be specified for each Module in the table:

- The name of the Module
- A reference to the Section in Annex C which defines the Module
- The usage of the Module; whether it is:
 - Mandatory (see A.1.3.1)
 - Conditional (see A.1.3.2)
 - User Option (see A.1.3.3)

The Modules referenced are defined in Annex C.

A.1.3.1 MANDATORY MODULES

For each IOD, Mandatory Modules shall be supported per the definitions, semantics and requirements defined in Annex C.

A.1.3.2 CONDITIONAL MODULES

Conditional Modules are Mandatory Modules if specific conditions are met. If the specified conditions are not met, this Module shall not be supported; that is, no information defined in that Module shall be sent.

A.1.3.3 USER OPTION MODULES

User Option Modules may or may not be supported. If an optional Module is supported, the Attribute Types specified in the Modules in Annex C shall be supported.

A.1.4 Overview of the Composite IOD Module Content

Tables A.1-1 and A.1-2 provide an overview of the Modules used throughout the Composite IODs. This table is for informative purposes only. It is based on the IOD definitions found in the remaining Sections of Annex A which are normative.

IODs Modules	CR	CT	MR	NM	US	US MF	SC	SC MF SB	SC MF GB	SC MF GW	SC MF TC	XA	RF	RT IM	PET	DX	MG	IO	VL EN	VL MC	VL SL	VL PH
-----------------	----	----	----	----	----	----------	----	----------------	----------------	----------------	----------------	----	----	----------	-----	----	----	----	----------	----------	----------	----------

X-Ray Tomo Acquisition													C			U	U	U				
X-Ray Acquisition Dose																U	U	U				
X-Ray Generation																U	U	U				
X-Ray Filtration																U	U	U				
X-Ray Grid																U	U	U				
XA Positioner												M										
DX Anatomy Imaged																M	M	M				
DX Image																M	M	M				
DX Detector																M	M	M				
DX Positioning																U	U	U				
Mammo Image																	M					
Intra-oral Image																		M				
VL Image																			M	M	M	M
Slide Coordinates																					M	
RT Image														M								
Approval														U								
Overlay Plane	U	U	U	U	U*		U					U	U		U	C	C	C	U	U	U	U

IODs Modules	CR	CT	MR	NM	US	US MF	SC	SC MF SB	SC MF GB	SC MF GW	SC MF TC	XA	RF	RT IM	PET	DX	MG	IO	VL EN	VL MC	VL SL	VL PH
-----------------	----	----	----	----	----	----------	----	----------------	----------------	----------------	----------------	----	----	----------	-----	----	----	----	----------	----------	----------	----------

Multi-frame Overlay				U								C	C										
Curve Identification					M*	M*																	
Curve	U			U	M*	M*						U	U	U			U	U	U				
Audio					U	U								U									
Modality LUT	U						U					C*	C*	U									
VOI LUT	U	U	U	U	U*	U	U		C	C		U	U	U	U		C	C	C				
Image Histogram																	U	U	U				
Acquisition Context																	M	M	M	M	M	M	M
SOP Common	M	M	M	M	M*	M*	M	M	M	M	M	M	M	M	M	M	M	M	M	M	M	M	M

* The notation next to M and U indicates a special condition for these modules. Refer to the corresponding Information Object Definitions in this Annex for details.

- Notes:
1. The original US Image IOD and US multi-frame IOD, and the associated US and US multi-frame Storage SOP Class UID have been retired. New US and US multi-frame Image IODs are defined, as shown in Table A.1-1 which includes the Palette Color Lookup Table module.
 2. The original NM Image IOD and the associated NM Storage SOP Class UID have been retired. A completely new NM Image IOD is defined, as shown in Table A.1-1.

**Table A.1-2
COMPOSITE INFORMATION OBJECT MODULES OVERVIEW - NON-IMAGES**

IODs Modules	St. OV	St. CV	Basic Study Descr.	St. Mod LUT	St. VOI LUT	Pre s St	RT Dose	RT Struc Set	RT Plan	RT Beam Rec	RT Bchy Rec	RT Sum	PET CV	Basic Voice Audio	12 Lead ECG	Gen ECG WF	Amb ECG WF	Hemo WF	Basic Card EP	Basic Text SR	Enhan SR	Comp SR	Key Object Seln	Mam CAD
Patient	M	M		M	M	M	M	M	M	M	M	M	M	M	M	M	M	M	M	M	M	M	M	M
Patient Summary			M																					
Specimen Identification																				C	C	C	C	C
General Study	M	M		M	M	M	M	M	M	M	M	M	M	M	M	M	M	M	M	M	M	M	M	M
Patient Study	U	U		U	U	U	U	U	U	U	U	U	U	U	U	U	U	U	U	U	U	U	U	U
Study Content			M																					
General Series	M	M		M	M	M							M	M	M	M	M	M	M					
PET Series													M											
PET Isotope													M											
PET Multi-gated Acquisition													C											
RT Series							M	M	M	M	M	M												
Presentation Series						M																		
SR Document Series																				M	M	M		M
Key Object Document Series																							M	
Frame Of Reference							M																	
Synchronizatio n														U	U	U	U	C	C					

IODs Modules	St. OV	St. CV	Basic Study Descr.	St. Mod LUT	St. VOI LUT	Pre s St	RT Dose	RT Struc Set	RT Plan	RT Beam Rec	RT Bchy Rec	RT Sum	PET CV	Basic Voice Audio	12 Lead ECG	Gen ECG WF	Amb ECG WF	Hemo WF	Basic Card EP	Basic Text SR	Enhan SR	Comp SR	Key Object Seln	Mam CAD
--------------	--------	--------	--------------------	-------------	-------------	----------	---------	--------------	---------	-------------	-------------	--------	--------	-------------------	-------------	------------	------------	---------	---------------	---------------	----------	---------	-----------------	---------

Softcopy VOI LUT						C																		
Softcopy Presentation LUT						M																		
Image Histogram																								
Presentation State						M																		
LUT Identification				M	M																			
Acquisition Context														M	M	M	U	M	M					
SOP Common	M	M	M	M	M		M	M	M	M	M	M	M	M	M	M	M	M	M	M	M	M	M	M

* The notation next to M and U indicates a special condition for these modules. Refer to the corresponding Information Object Definitions in this Annex for details.

A.2 COMPUTED RADIOGRAPHY IMAGE INFORMATION OBJECT DEFINITION

A.2.1 CR Image IOD Description

The Computed Radiography (CR) Image Information Object Definition specifies an image which has been created by a computed radiography imaging device.

Note: Digital Luminescence Radiography is an equivalent term for computed Radiography.

A.2.2 CR Image IOD Entity-Relationship Model

The E-R Model in Section A.1.2 depicts those components of the DICOM Information Model which directly reference the CR Image IOD. The Frame of Reference IE, Overlay IE, Modality LUT IE, VOI LUT IE and Curve IE are not components of the CR Image IOD.

A.2.3 CR Image IOD Module Table

**Table A.2-1
CR IMAGE IOD MODULES**

IE	Module	Reference	Usage
Patient	Patient	C.7.1.1	M
Study	General Study	C.7.2.1	M
	Patient Study	C.7.2.2	U
Series	General Series	C.7.3.1	M
	CR Series	C.8.1.1	M
Equipment	General Equipment	C.7.5.1	M
Image	General Image	C.7.6.1	M
	Image Pixel	C.7.6.3	M
	Contrast/bolus	C.7.6.4	C - Required if contrast media was used in this image
	CR Image	C.8.1.2	M
	Overlay Plane	C.9.2	U
	Curve	C.10.2	U
	Modality LUT	C.11.1	U
	VOILUT	C.11.2	U
	SOP Common	C.12.1	M

A.3 COMPUTED TOMOGRAPHY IMAGE INFORMATION OBJECT DEFINITION

A.3.1 CT Image IOD Description

The Computed Tomography (CT) Image Information Object Definition (IOD) specifies an image which has been created by a computed tomography imaging device.

A.3.2 CT image IOD Entity-Relationship Model

The E-R Model in Section A.1.2 depicts those components of the DICOM Information Model which directly reference the CT Image IOD. The Overlay IE, Modality LUT IE, VOI LUT IE and Curve IE are not components of the CT Image IOD.

A.3.3 CT Image IOD Module Table

**Table A.3-1
CT IMAGE IOD MODULES**

IE	Module	Reference	Usage
Patient	Patient	C.7.1.1	M
Study	General Study	C.7.2.1	M
	Patient Study	C.7.2.2	U
Series	General Series	C.7.3.1	M
Frame of Reference	Frame of Reference	C.7.4.1	M
Equipment	General Equipment	C.7.5.1	M
Image	General Image	C.7.6.1	M
	Image Plane	C.7.6.2	M
	Image Pixel	C.7.6.3	M
	Contrast/bolus	C.7.6.4	C - Required if contrast media was used in this image
	CT Image	C.8.2.1	M
	Overlay Plane	C.9.2	U
	VOI LUT	C.11.2	U
	SOP Common	C.12.1	M

A.4 MAGNETIC RESONANCE IMAGE INFORMATION OBJECT DEFINITION

A.4.1 MR Image IOD Description

The Magnetic Resonance (MR) Image Information Object Definition (IOD) specifies an image which has been created by a magnetic resonance imaging device.

A.4.2 MR image IOD Entity-Relationship Model

The E-R Model in Section A.1.2 depicts those components of the DICOM Information Model which directly reference the MR Image IOD. The Overlay IE, Modality LUT IE, VOI LUT IE and Curve IE are not components of the MR Image IOD.

A.4.3 MR Image IOD Module Table

**Table A.4-1
MR IMAGE IOD MODULES**

IE	Module	Reference	Usage
Patient	Patient	C.7.1.1	M
Study	General Study	C.7.2.1	M
	Patient Study	C.7.2.2	U
Series	General Series	C.7.3.1	M
Frame of Reference	Frame of Reference	C.7.4.1	M
Equipment	General Equipment	C.7.5.1	M
Image	General Image	C.7.6.1	M
	Image Plane	C.7.6.2	M
	Image Pixel	C.7.6.3	M
	Contrast/bolus	C.7.6.4	C - Required if contrast media was used in this image
	MR Image	C.8.3.1	M
	Overlay Plane	C.9.2	U
	VOI LUT	C.11.2	U
	SOP Common	C.12.1	M

A.5 NUCLEAR MEDICINE IMAGE INFORMATION OBJECT DEFINITION

A.5.1 NM Image IOD Description

The Nuclear Medicine (NM) Image Information Object Definition (IOD) specifies an image which has been created by a nuclear medicine imaging device. This includes data created by external detection devices which create images of the distribution of administered radioactive materials in the body. Depending on the specific radio pharmaceutical administered and the particular imaging procedure performed, problems involving changes in metabolism, function, or physiology can be investigated and various regional pathologies can be studied.

A.5.2 NM Image IOD Entity-Relationship Model

The E-R Model in Section A.1.2 depicts those components of the DICOM Information Model which directly reference the NM Image IOD. The Modality LUT IE and VOI LUT IE are not components of the NM Image IOD.

A.5.3 NM Image IOD Module Table (Retired)

Section A.5.3 was defined in a previous version of the DICOM Standard. The Section is now retired.

A.5.4 NM Image IOD Module Table

**Table A.5-1
NM IMAGE IOD MODULES**

IE	Module	Reference	Usage
Patient	Patient	C.7.1.1	M
Study	General Study	C.7.2.1	M
	Patient Study	C.7.2.2	U
Series	General Series	C.7.3.1	M
	NM/PET Patient Orientation	C.8.4.6	M
Frame of Reference	Frame of Reference	C.7.4.1	U
Equipment	General Equipment	C.7.5.1	M
Image	General Image	C.7.6.1	M
	Image Pixel	C.7.6.3	M
	NM Image Pixel	C.8.4.7	M
	Multi-frame	C.7.6.6	M
	NM Multi-frame	C.8.4.8	M
	NM Image	C.8.4.9	M
	NM Isotope	C.8.4.10	M
	NM Detector	C.8.4.11	M
	NM TOMO Acquisition	C.8.4.12	C - Required if Image Type (0008,0008) Value 3 is TOMO, GATED TOMO, RECON TOMO or RECON GATED TOMO
	NM Multi-gated Acquisition	C.8.4.13	C - Required if Image Type (0008,0008) Value 3 is GATED, GATED TOMO, or RECON GATED TOMO
	NM Phase	C.8.4.14	C - Required if Image Type (0008,0008) Value 3 is DYNAMIC
	NM Reconstruction	C.8.4.15	C - Required if Image Type (0008,0008) Value 3 is RECON TOMO or RECON GATED TOMO
	Overlay Plane	C.9.2	U
	Multi-frame Overlay	C.9.3	U
	Curve	C.10.2	U
	VOI LUT	C.11.2	U
	SOP Common	C.12.1	M

A.6 ULTRASOUND IMAGE INFORMATION OBJECT DEFINITION

A.6.1 US Image IOD Description

The Ultrasound (US) Image Information Object Definition specifies an image which has been created by an ultrasound imaging device.

A.6.2 US Image IOD Entity-Relationship Model

The E-R Model in Section A.1.2 depicts those components of the DICOM Information Model which directly reference the US Image IOD. The Overlay IE, Modality LUT IE and VOI LUT IE are not components of the US Image IOD.

A.6.3 US Image IOD Module Table (Retired)

Section A.6.3 was defined in a previous version of the DICOM Standard. The Section is now retired.

A.6.4 US Image IOD Module Table

**Table A.6-1
US IMAGE IOD MODULES**

IE	Module	Reference	Usage
Patient	Patient	C.7.1.1	M
Study	General Study	C.7.2.1	M
	Patient Study	C.7.2.2	U
Series	General Series	C.7.3.1	M
Frame of Reference	Frame of Reference	C.7.4.1	U
	US Frame of Reference	C.8.5.4	C - Required if images are spatially related
	Synchronization	C.7.4.2	U
Equipment	General Equipment	C.7.5.1	M
Image (See A.6.4.1)	General Image	C.7.6.1	M
	Image Pixel	C.7.6.3	M
	Contrast/bolus	C.7.6.4	C - Required if contrast media was used in this image
	Palette Color Lookup Table	C.7.9	C - Required if Photometric Interpretation (0028,0004) has a value of PALETTE COLOR
	US Region Calibration	C.8.5.5	U
	US Image	C.8.5.6	M
	Overlay Plane	C.9.2	U
	VOI LUT	C.11.2	U
	SOP Common	C.12.1	M
Curve (See A.6.4.1)	Curve Identification	C.10.1	M
	Curve	C.10.2	M
	Audio	C.10.3	U
	SOP Common	C.12.1	M

Note: For the purpose of conveying ultrasound protocol data management information it is recommended that the Performed Protocol Code Sequence (0040,0260) be assigned the code value(s) of the performed ultrasound protocol, if any. The Baseline Context Group for these code values is Context ID 12001 (defined in PS 3.16).

A.6.4.1 Mutually Exclusive IEs

The Image and Curve IEs are mutually exclusive. Each SOP Instance using this IOD shall contain exactly one of these IEs.

A.7 ULTRASOUND MULTI-FRAME IMAGE INFORMATION OBJECT DEFINITION

A.7.1 US Image IOD Description

The Ultrasound (US) Multi-frame Image Information Object Definition specifies a Multi-frame image which has been created by an ultrasound imaging device.

A.7.2 US Multi-Frame Image IOD Entity-Relationship Model

The E-R Model in Section A.1.2 depicts those components of the DICOM Application Information Model which directly reference the US Multi-frame Image IOD. The Overlay IE, Modality LUT IE and VOI LUT IE are not components of the US Multi-frame Image IOD.

A.7.3 US Image IOD Module Table (Retired)

Section A.7.3 was defined in a previous version of the DICOM Standard. The Section is now retired.

A.7.4 US Multi-Frame Image IOD Module Table

**Table A.7-1
US MULTI-FRAME IMAGE IOD MODULES**

IE	Module	Reference	Usage
Patient	Patient	C.7.1.1	M
Study	General Study	C.7.2.1	M
	Patient Study	C.7.2.2	U
Series	General Series	C.7.3.1	M
Frame of Reference	Frame of Reference	C.7.4.1	U
	US Frame of Reference	C.8.5.4	C - Required if images are spatially related
	Synchronization	C.7.4.2	C – Required if Modality (0008,0060) = IVUS. May be present otherwise.
Equipment	General Equipment	C.7.5.1	M
Image (See A.7.4.1)	General Image	C.7.6.1	M
	Image Pixel	C.7.6.3	M
	Contrast/bolus	C.7.6.4	C - Required if contrast media was used in this image.
	Cine	C.7.6.5	M
	Multi-frame	C.7.6.6	M
	Palette Color Lookup Table	C.7.9	C - Required if Photometric Interpretation (0028,0004) has a value of PALETTE COLOR
	US Region Calibration	C.8.5.5	U
	US Image	C.8.5.6	M
	VOI LUT	C.11.2	U
	SOP Common	C.12.1	M
Curve (see A.7.4.1)	Curve Identification	C.10.1	M
	Curve	C.10.2	M
	Audio	C.10.3	U
	SOP Common	C.12.1	M

Note: For the purpose of conveying ultrasound protocol data management information it is recommended that the Performed Protocol Code Sequence (0040,0260) be assigned the code value(s) of the performed ultrasound protocol, if any. The Baseline Context Group for these code values is Context ID 12001 (defined in PS 3.16).

A.7.4.1 MUTUALLY EXCLUSIVE IES

The Image and Curve IEs are mutually exclusive. Each SOP Instance using this IOD shall contain exactly one of these IEs.

A.8 SECONDARY CAPTURE IMAGE INFORMATION OBJECT DEFINITION

The Secondary Image (SC) Image Information Object Definition (IOD) specifies images that are converted from a non-DICOM format to a modality independent DICOM format.

Examples of types of equipment that create Secondary Capture Images include:

- a. Video interfaces that convert an analog video signal into a digital image
- b. Digital interfaces that are commonly used to transfer non-DICOM digital images from an imaging device to a laser printer
- c. Film digitizers that convert an analog film image to digital data
- d. Workstations that construct images that are sent out as a screen dump
- e. Scanned documents and other bitmap images including hand-drawings
- f. Synthesized images that are not modality-specific, such as cine-loops of 3D reconstructions

Originally, a single, relatively unconstrained, single-frame SC Image IOD was defined in the DICOM Standard. Though this IOD is retained and not retired since it is in common use, more specific IODs for particular categories of application are also defined.

The following IODs are all multi-frame. A single frame image is encoded as a multi-frame image with only one frame. The multi-frame SC IODs consist of:

- Multi-frame Single Bit Secondary Capture Image IOD
- Multi-frame Grayscale Byte Secondary Capture Image IOD
- Multi-frame Grayscale Word Secondary Capture Image IOD
- Multi-frame True Color Secondary Capture Image IOD

A.8.1 SC Image Information Object Definition

A.8.1.1 SC Image IOD Description

The Secondary Image (SC) Image Information Object Definition (IOD) specifies single-frame images that are converted from a non-DICOM format to a modality independent DICOM format, without any constraints on pixel data format.

Note: The use of this IOD is deprecated, and other more specific SC Image IODs should be used.

A.8.1.2 SC Image IOD Entity-Relationship Model

The E-R Model in Section A.1.2 depicts those components of the DICOM Information Model which directly reference the Secondary Capture Image IOD. The Frame of Reference IE and Curve IE are not components of this IOD.

A.8.1.3 SC Image IOD Module Table

**Table A.8-1
SC IMAGE IOD MODULES**

IE	Module	Reference	Usage
Patient	Patient	C.7.1.1	M
Study	General Study	C.7.2.1	M
	Patient Study	C.7.2.2	U
Series	General Series	C.7.3.1	M
Equipment	General Equipment	C.7.5.1	U
	SC Equipment	C.8.6.1	M
Image	General Image	C.7.6.1	M
	Image Pixel	C.7.6.3	M
	SC Image	C.8.6.2	M
	Overlay Plane	C.9.2	U
	Modality LUT	C.11.1	U
	VOI LUT	C.11.2	U
	SOP Common	C.12.1	M

A.8.2 Multi-frame Single Bit SC Image Information Object Definition

A.8.2.1 Multi-frame Single Bit SC Image IOD Description

The Multi-frame Single Bit Secondary Capture (SC) Image Information Object Definition (IOD) specifies images that are converted from a non-DICOM format to a modality independent DICOM format.

This IOD is typically used for scanned documents and bitmap images of hand drawings.

A.8.2.2 Multi-frame Single Bit SC Image IOD Entity-Relationship Model

The E-R Model in Section A.1.2 depicts those components of the DICOM Information Model which directly reference the Secondary Capture Image family of IODs. The Frame of Reference IE, Overlay IE, Modality LUT IE, VOI LUT IE and Curve IE are not components of this IOD.

A.8.2.3 SC Image IOD Module Table

**Table A.8-2
MULTI-FRAME SINGLE BIT SC IMAGE IOD MODULES**

IE	Module	Reference	Usage
Patient	Patient	C.7.1.1	M
Study	General Study	C.7.2.1	M
	Patient Study	C.7.2.2	U
Series	General Series	C.7.3.1	M
Equipment	General Equipment	C.7.5.1	U
	SC Equipment	C.8.6.1	M
Image	General Image	C.7.6.1	M
	Image Pixel	C.7.6.3	M
	Cine	C.7.6.5	C – Required if Frame Increment Pointer (0028,0009) is Frame Time (0018,1063) or Frame Time Vector (0018,1065)
	Multi-frame	C.7.6.6	M
	Frame Pointers	C.7.6.9	U
	SC Image	C.8.6.2	U
	SC Multi-frame Image	C.8.6.3	M
	SC Multi-frame Vector	C.8.6.4	C – Required if Number of Frames is greater than 1
	SOP Common	C.12.1	M

A.8.2.4 Multi-frame Single Bit SC Image IOD Content Constraints

In the Image Pixel Module, the following constraints apply:

- Samples per Pixel (0028,0002) shall be 1
- Photometric Interpretation (0028,0004) shall be MONOCHROME2
- Bits Allocated (0028,0100) shall be 1
- Bits Stored (0028,0101) shall be 1
- High Bit (0028,0102) shall be 0
- Pixel Representation (0028,0103) shall be 0
- Planar Configuration (0028,0006) shall not be present

Note: As a consequence of these attribute values, single bit pixels are packed eight to a byte as defined by the encoding rules in PS 3.5.

The VOI LUT module shall not be present.

The Overlay module shall not be present.

A.8.3 Multi-frame Grayscale Byte SC Image Information Object Definition

A.8.3.1 Multi-frame Grayscale Byte Image IOD Description

The Multi-frame Grayscale Byte Secondary Capture (SC) Image Information Object Definition (IOD) specifies Grayscale Byte images that are converted from a non-DICOM format to a modality independent DICOM format.

This IOD is typically used for screen captured images for modalities that have pixel values of 8 bits, but may also be appropriate for scanned grayscale documents.

A.8.3.2 Multi-frame Grayscale Byte SC Image IOD Entity-Relationship Model

The E-R Model in Section A.1.2 depicts those components of the DICOM Information Model which directly reference the Secondary Capture Image family of IODs. The Frame of Reference IE, Overlay IE, Modality LUT IE and Curve IE are not components of this IOD.

A.8.3.3 Multi-frame Grayscale Byte SC Image IOD Module Table

**Table A.8-3
MULTI-FRAME GRAYSCALE BYTE SC IMAGE IOD MODULES**

IE	Module	Reference	Usage
Patient	Patient	C.7.1.1	M
Study	General Study	C.7.2.1	M
	Patient Study	C.7.2.2	U
Series	General Series	C.7.3.1	M
Equipment	General Equipment	C.7.5.1	U
	SC Equipment	C.8.6.1	M
Image	General Image	C.7.6.1	M
	Image Pixel	C.7.6.3	M
	Cine	C.7.6.5	C – Required if Frame Increment Pointer (0028,0009) is Frame Time (0018,1063) or Frame Time Vector (0018,1065)
	Multi-frame	C.7.6.6	M
	Frame Pointers	C.7.6.9	U
	SC Image	C.8.6.2	U
	SC Multi-frame Image	C.8.6.3	M
	SC Multi-frame Vector	C.8.6.4	C – Required if Number of Frames is greater than 1
	VOI LUT	C.11.2	C – Required if the VOI LUT stage is not an identity transformation
SOP Common	C.12.1	M	

A.8.3.4 Multi-frame Grayscale Byte SC Image IOD Content Constraints

The VOI LUT module is required if the VOI LUT stage is not an identity transformation. Support for both window and LUT is mandatory. The output grayscale space is defined to be in P-Values.

Note: If the VOI LUT module is absent, then the stored pixel values are in P-Values.

In the Image Pixel Module, the following constraints apply:

- Samples per Pixel (0028,0002) shall be 1
- Photometric Interpretation (0028,0004) shall be MONOCHROME2
- Bits Allocated (0028,0100) shall be 8
- Bits Stored (0028,0101) shall be 8
- High Bit (0028,0102) shall be 7
- Pixel Representation (0028,0103) shall be 0
- Planar Configuration (0028,0006) shall not be present

The Overlay module shall not be present.

A.8.4 Multi-frame Grayscale Word SC Image Information Object Definition

A.8.4.1 Multi-frame Grayscale Word SC Image IOD Description

The Multi-frame Grayscale Word Secondary Capture (SC) Image Information Object Definition (IOD) specifies Grayscale Word images that are converted from a non-DICOM format to a modality independent DICOM format.

This IOD is typically used for screen captured images for modalities that have pixel values greater than 8 bits.

A.8.4.2 Multi-frame Grayscale Word SC Image IOD Entity-Relationship Model

The E-R Model in Section A.1.2 depicts those components of the DICOM Information Model which directly reference the Secondary Capture Image family of IODs. The Frame of Reference IE, Overlay IE, Modality LUT IE and Curve IE are not components this IOD.

A.8.4.3 Multi-frame Grayscale Word SC Image IOD Module Table

**Table A.8-4
MULTI-FRAME GRAYSCALE WORD SC IMAGE IOD MODULES**

IE	Module	Reference	Usage
Patient	Patient	C.7.1.1	M
Study	General Study	C.7.2.1	M
	Patient Study	C.7.2.2	U
Series	General Series	C.7.3.1	M
Equipment	General Equipment	C.7.5.1	U
	SC Equipment	C.8.6.1	M
Image	General Image	C.7.6.1	M
	Image Pixel	C.7.6.3	M
	Cine	C.7.6.5	C – Required if Frame Increment Pointer (0028,0009) is Frame Time (0018,1063) or Frame Time Vector (0018,1065)
	Multi-frame	C.7.6.6	M
	Frame Pointers	C.7.6.9	U
	SC Image	C.8.6.2	U
	SC Multi-frame Image	C.8.6.3	M
	SC Multi-frame Vector	C.8.6.4	C – Required if Number of Frames is greater than 1
	VOI LUT	C.11.2	C – Required if the VOI LUT stage is not an identity transformation
SOP Common	C.12.1	M	

A.8.4.4 Multi-frame Grayscale Word SC Image IOD Content Constraints

The VOI LUT module is required if the VOI LUT stage is not an identity transformation. Support for both window and LUT is mandatory. The output grayscale space is defined to be in P-Values.

Note: If the VOI LUT module is absent, then the stored pixel values are in P-Values.

In the Image Pixel Module, the following constraints apply:

- Samples per Pixel (0028,0002) shall be 1
- Photometric Interpretation (0028,0004) shall be MONOCHROME2
- Bits Allocated (0028,0100) shall be 16
- Bits Stored (0028,0101) shall be greater than or equal to 9 and less than or equal to 16
- High Bit (0028,0102) shall be one less than Bits Stored (0028,0101)
- Pixel Representation (0028,0103) shall be 0
- Planar Configuration (0028,0006) shall not be present

The Overlay module shall not be present. Unused high bits shall be filled with zeroes.

A.8.5 Multi-frame True Color SC Image Information Object Definition

A.8.5.1 Multi-frame True Color Image IOD Description

The Multi-frame True Color Secondary Capture (SC) Image Information Object Definition (IOD) specifies True Color images that are converted from a non-DICOM format to a modality independent DICOM format.

This IOD is typically used for screen captured or synthetic images where true color is used, but may also be appropriate for scanned color documents.

A.8.5.2 Multi-frame True Color SC Image IOD Entity-Relationship Model

The E-R Model in Section A.1.2 depicts those components of the DICOM Information Model which directly reference the Secondary Capture Image family of IODs. The Frame of Reference IE, Overlay IE, Modality LUT IE, VOI LUT IE and Curve IE are not components of the this IOD.

A.8.5.3 Multi-frame True Color SC Image IOD Module Table

**Table A.8-5
MULTI-FRAME TRUE COLOR SC IMAGE IOD MODULES**

IE	Module	Reference	Usage
Patient	Patient	C.7.1.1	M
Study	General Study	C.7.2.1	M
	Patient Study	C.7.2.2	U
Series	General Series	C.7.3.1	M
Equipment	General Equipment	C.7.5.1	U
	SC Equipment	C.8.6.1	M
Image	General Image	C.7.6.1	M
	Image Pixel	C.7.6.3	M
	Cine	C.7.6.5	C – Required if Frame Increment Pointer (0028,0009) is Frame Time (0018,1063) or Frame Time Vector (0018,1065)
	Multi-frame	C.7.6.6	M
	Frame Pointers	C.7.6.9	U
	SC Image	C.8.6.2	U
	SC Multi-frame Image	C.8.6.3	M
	SC Multi-frame Vector	C.8.6.4	C – Required if Number of Frames is greater than 1
	SOP Common	C.12.1	M

A.8.5.4 Multi-frame True Color SC Image IOD Content Constraints

The VOI LUT module shall not be present.

In the Image Pixel Module, the following constraints apply:

- Samples per Pixel (0028,0002) shall be 3

- Photometric Interpretation (0028,0004) shall be RGB for uncompressed or lossless compressed transfer syntaxes, and YBR_FULL_422 for lossy compressed transfer syntaxes

Note: Future lossless and lossy transfer syntaxes may lead to the need for new definitions and choices for Photometric Interpretation, such as the proposed RC T (Reversible Color Transformation) used in JPEG 2000.

- Bits Allocated (0028,0100) shall be 8
- Bits Stored (0028,0101) shall be 8
- High Bit (0028,0102) shall be 7
- Pixel Representation (0028,0103) shall be 0
- Planar Configuration (0028,0006) shall be 0 (color-by-pixel) if Photometric Interpretation (0028,0004) is RGB

The Overlay module shall not be present.

A.9 STANDALONE OVERLAY INFORMATION OBJECT DEFINITION

A.9.1 Standalone Overlay IOD Description

A Standalone Overlay IOD is the specification of an overlay which may be related to an Image, but also may have its own existence within a Series. The Standalone Overlay IOD is modality independent. It provides a mechanism to convey bit-mapped text, graphical information, etc. included in a Series.

A.9.2 Standalone Overlay IOD Entity-Relationship Model

The E-R Model in Section A.1.2 depicts those components of the DICOM Information Model which directly reference the Standalone Overlay IOD. The Frame of Reference IE, Image IE, Modality LUT IE, VOI LUT IE and Curve IE are not components of the Standalone Overlay IOD.

A.9.3 Standalone Overlay IOD Module Table

**Table A.9-1
STANDALONE OVERLAY IOD MODULES**

IE	Module	Reference	Usage
Patient	Patient	C.7.1.1	M
Study	General Study	C.7.2.1	M
	Patient Study	C.7.2.2	U
Series	General Series	C.7.3.1	M
Equipment	General Equipment	C.7.5.1	M
Overlay	Overlay Identification	C.9.1	M
	Overlay Plane (see note)	C.9.2	M
	SOP Common	C.12.1	M

Note: The Attribute Overlay Data (60xx,3000) allows for overlay data to be encoded in the pixel data in Group 7FE0H. For this Standalone Overlay IOD, Group 7FE0H does not exist and therefore the overlay data is contained in the Overlay Data Attribute.

A.10 STANDALONE CURVE INFORMATION OBJECT DEFINITION

A.10.1 Standalone Curve IOD Description

A Standalone Curve IOD is the specification of an curve which may be related to an Image, but also may have its own existence within a Series. The Standalone Curve IOD is modality independent.

A.10.2 Standalone Curve IOD Entity-Relationship Model

The E-R Model in Section A.1.2 depicts those components of the DICOM Information Model which directly reference the Standalone Curve IOD. The Frame of Reference IE, Overlay IE, Modality LUT IE, VOI LUT IE and Image IE are not components of the Standalone Curve IOD.

A.10.3 Standalone Curve IOD Module Table

**Table A.10-1
STANDALONE CURVE IOD MODULES**

IE	Module	Reference	Usage
Patient	Patient	C.7.1.1	M
Study	General Study	C.7.2.1	M
	Patient Study	C.7.2.2	U
Series	General Series	C.7.3.1	M
Equipment	General Equipment	C.7.5.1	M
Curve	Curve Identification	C.10.1	M
	Curve	C.10.2	M
	SOP Common	C.12.1	M

A.11 BASIC STUDY DESCRIPTOR INFORMATION OBJECT DEFINITION

A.11.1 Basic Study Descriptor IOD Description

A Basic Study Descriptor IOD is the specification of an abstract information model of summary information for a Study, which may be exchanged between connecting devices which claim conformance to the DICOM Standard. This Basic Study Descriptor is intended to be modality independent. It is intended to provide a simple "directory" for a study to explicitly convey references to the content of a study.

A.11.2 Basic Study Descriptor Entity-Relationship Model

The E-R model for the Basic Study Descriptor Information Object Definition is shown in Figure A.11-1.

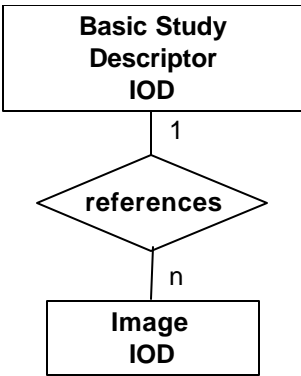

**Figure A.11-1
BASIC STUDY DESCRIPTOR INFORMATION OBJECT DEFINITION E-R MODEL**

A.11.3 Basic Study Descriptor IOD Module Table

**Table A.11-1
BASIC STUDY DESCRIPTOR IOD MODULE TABLE**

Module	Reference	Usage
Patient Summary	C.7.7	M
Study Content	C.7.8	M
SOP Common	C.12.1	M

A.12 STANDALONE MODALITY LUT INFORMATION OBJECT DEFINITION

A.12.1 Standalone Modality LUT IOD Description

The Standalone Modality LUT IOD specifies one or more Modality LUTs that are related to an Image.

A.12.2 Standalone Modality LUT IOD Entity-Relationship Model

The E-R Model in Section A.1.2 depicts those components of the DICOM Information Model which directly reference the Standalone Modality LUT IOD. The Frame of Reference IE, Overlay IE, Curve IE, VOI LUT IE and Image IE are not components of the Standalone Modality LUT IOD.

A.12.3 Standalone Modality LUT IOD Module Table

**Table A.12-1
STANDALONE MODALITY LUT IOD MODULES**

IE	Module	Reference	Usage
Patient	Patient	C.7.1.1	M
Study	General Study	C.7.2.1	M
	Patient Study	C.7.2.2	U
Series	General Series	C.7.3.1	M
Equipment	General Equipment	C.7.5.1	M
Modality LUT	Modality LUT Module	C.11.1	M
	LUT Identification	C.11.3	M
	SOP Common	C.12.1	M

A.13 STANDALONE VOI LUT INFORMATION OBJECT DEFINITION

A.13.1 Standalone VOI LUT IOD Description

The Standalone VOI LUT IOD specifies one or more VOI LUTs that are related to an Image.

A.13.2 Standalone VOI LUT IOD Entity-Relationship Model

The E-R Model in Section A.1.2 depicts those components of the DICOM Information Model which directly reference the Standalone VOI LUT IOD. The Frame of Reference IE, Overlay IE, Curve IE, Modality LUT IE and Image IE are not components of the Standalone VOI LUT IOD.

A.13.3 Standalone VOI LUT IOD Module Table

**Table A.13-1
STANDALONE VOI LUT IOD MODULES**

IE	Module	Reference	Usage
Patient	Patient	C.7.1.1	M
Study	General Study	C.7.2.1	M
	Patient Study	C.7.2.2	U
Series	General Series	C.7.3.1	M
Equipment	General Equipment	C.7.5.1	M
VOI LUT	VOI LUT Module	C.11.2	M
	LUT Identification	C.11.3	M
	SOP Common	C.12.1	M

A.14 X-RAY ANGIOGRAPHIC IMAGE INFORMATION OBJECT DEFINITION

A.14.1 XA Image IOD Description

This Section defines the Information Object for single plane X-Ray Angiographic Imaging which includes those data elements and information objects necessary for the interchange of digital X-Ray Angiographic data. This includes images of the heart and all blood vessels.

The XA IOD share a significant amount of common information with the XRF IOD. The differences between the two IODs are that the XRF Image IOD includes a tomography module; and the two IODs utilize different methods to specify positioner angles. The XRF Image IOD contains a single column angulation Data Element which uses an equipment based coordinate system, while XA Image IOD c-arm positioner angles are specified in a patient based coordinate system. RF applications which support a patient-based coordinate system with cranial/caudal, LAO/RAO angles may utilize the XA IOD.

The XA IOD is also applicable to clinical areas other than angiography (e.g. Interventional Procedures, Myelography, Biopsy/Localization, and Neurology).

- Note:
1. For the purpose of X-Ray Angiography (XA), this IOD can be used to encode a single frame image, or a Cine Run encoded in a single multi-frame image.
 2. A typical study might include all the images generated between the time a patient gets on and gets off the procedure table. As several separable diagnostic or therapeutic processes may occur during a single study (e.g., pre-intervention CA, left ventriculography, and post-intervention CA), a series may be defined as comprising a set of images (single or Multi-Frame) associated with one such process within a study.
 3. This IOD can be used to encode a single plane acquisition, or one plane of a biplane acquisition.

A.14.2 XA Image IOD Entity-Relationship Model

The E-R Model in Section A.1.2 depicts those components of the DICOM Application Information Model which directly reference the X-Ray Angiographic Image IOD, with exception of the Frame of Reference and Modality LUT entities which are not used. Additionally, "Image" in Figure A.1-1 may represent a Single Frame or a Multi-Frame image. A frame denotes a two-dimensional organization of pixels recorded as a single exposure.

A.14.3 XA Image IOD Module Table

**Table A.14.-1
X-RAY ANGIOGRAPHIC IMAGE IOD MODULES**

IE	Module	Reference	Usage
Patient	Patient	C.7.1.1	M
Study	General Study	C.7.2.1	M
	Patient Study	C.7.2.2	U
Series	General Series	C.7.3.1	M
Equipment	General Equipment	C.7.5.1	M
Image	General Image	C.7.6.1	M
	Image Pixel	C.7.6.3	M
	Contrast/Bolus	C.7.6.4	C - Required if contrast media was used in this Image
	Cine	C.7.6.5	C - Required if pixel data is Multi-Frame Cine data
	Multi-Frame	C.7.6.6	C - Required if pixel data is Multi-Frame Cine data
	Frame Pointers	C.7.6.9	U
	Mask	C.7.6.10	C - Required if the Image may be subtracted
	Display Shutter	C.7.6.11	U
	Device	C.7.6.12	U
	Therapy	C.7.6.13	U
	X-Ray Image	C.8.7.1	M
	X-Ray Acquisition	C.8.7.2	M
	X-Ray Collimator	C.8.7.3	U
	X-Ray Table	C.8.7.4	C - Required if Image is created with table motion
	XA Positioner	C.8.7.5	M
	Overlay Plane	C.9.2	U
	Multi-Frame Overlay	C.9.3	C - Required if Overlay data contains multiple frames.
	Curve	C.10.2	U (See C.8.7.1.1.9)
	Modality LUT	C.11.1	C - Required if Pixel Intensity Relationship (0028,1040) is LOG U - Optional if Pixel Intensity Relationship (0028,1040) is DISP
	VOI LUT	C.11.2	U
SOP Common	C.12.1	M	

A.15 X-RAY ANGIOGRAPHIC BI-PLANE IMAGE INFORMATION OBJECT DEFINITION (RETIRED)

A.16 X-RAY RF IMAGE INFORMATION OBJECT DEFINITION

A.16.1 XRF Image IOD Description

The focus for this X-Ray RF Image IOD (XRF IOD) is to address the requirements for image transfer found in general Radiofluoroscopic applications performed on a table with a column. For applications performed on X-Ray RF acquisition systems which support a patient based coordinate system with cranial/caudal, LAO/RAO angles, etc. the XA Image IOD may be used.

Note: An example of a case where the XA IOD may be preferred to the RF IOD are RF acquisition system equipped with an X-Ray source and an image Receptor positioned by what is generally called a c-arm (e.g. Interventional Procedures, Myelography, Biopsy, and Neurology).

This Section defines the Information Object for X-Ray Radiofluoroscopic Imaging which includes those data elements and information objects necessary for the interchange of digital X-Ray RF Image data. The XRF IOD is applicable to X-Ray acquisition systems equipped with an image receptor whose plane is parallel to the table plane where the patient is. This Table has in general the ability to be tilted. Furthermore the X-Ray source may be supported by a column which can be angulated to adjust the incidence of the X-Ray beam on the image receptor plan. An equipment based coordinated system is used to track these angles.

Notes: 1. For the purpose of X-Ray Radiofluoroscopy, this IOD can be used to encode a single frame image, or a cine run encoded in a single multi-frame image.
2. A typical study might include all the images generated between the time a patient gets on and gets off the procedure table. As several separable diagnostic or therapeutic processes may occur during a single study, a series may be defined as comprising a set of images (single or Multi-Frame) associated with one such process within a study.

A.16.2 XRF Image IOD Entity-Relationship Model

The E-R Model in Section A.1.2 depicts those components of the DICOM Application Information Model which directly reference the X-Ray RF Image IOD, with exception of the Frame of Reference entity which is not used. Additionally, "Image" in figure A.1-1 may represent a Single Frame or a Multi-Frame image. A frame denotes a two-dimensional organization of pixels recorded as a single exposure.

Note: When a Study (or Study Component) contains a number of Multi-frame images which do not need to be grouped under different Series, a single Series may be used with a series number containing an arbitrary value (e.g. 1).

A.16.3 XRF Image IOD Module Table

Table A.16-1 - XRF IMAGE IOD MODULES

IE	Module	Reference	Usage
Patient	Patient	C.7.1.1	M
Study	General Study	C.7.2.1	M
	Patient Study	C.7.2.2	U
Series	General Series	C.7.3.1	M
Equipment	General Equipment	C.7.5.1	M
Image	General Image	C.7.6.1	M
	Image Pixel	C.7.6.3	M
	Contrast/bolus	C.7.6.4	C - Required if contrast media was used in this Image
	Cine	C.7.6.5	C - Required if pixel data is Multi-Frame Cine Data
	Multi-Frame	C.7.6.6	C - Required if pixel data is Multi-Frame Cine Data
	Frame Pointers	C.7.6.9	U
	Mask	C.7.6.10	C - Required if the Image may be subtracted
	X-Ray Image	C.8.7.1	M
	X-Ray Acquisition	C.8.7.2	M
	X-Ray Collimator	C.8.7.3	U
	Display Shutter	C.7.6.11	U
	Therapy	C.7.6.12	U
	Device	C.7.6.13	U
	X-Ray Table	C.8.7.4	U
	XRF Positioner	C.8.7.6	U
	X-Ray Tomo Acquisition	C.8.7.7	C - Required if Scan Option (0018,0022) is TOMO
	Overlay Plane	C.9.2	U
	Multi-frame Overlay	C.9.3	C - Required if Overlay Data contains multiple frames
	Curve	C.10.2	U
	Modality LUT	C.11.1	C - Required if Pixel Intensity Relationship (0028,1040) is LOG U - Optional if Pixel Intensity Relationship (0028,1040) is DISP
VOI LUT	C.11.2	U	
SOP Common	C.12.1	M	

A.17 RT IMAGE INFORMATION OBJECT DEFINITION

A.17.1 RT Image IOD Description

The focus for this Radiotherapy Image IOD (RT Image IOD) is to address the requirements for image transfer found in general radiotherapy applications performed on conventional simulators, virtual simulators, and portal imaging devices. Such images have a conical imaging geometry and may either be acquired directly from the device, or digitized using a film digitizer. They may or may not have superimposed curves describing beam limiting device (collimator) openings, beam modifying devices, patient structures and target volumes. Numeric beam data parameters may also be recorded with the image, indicating the parameter values at the time the image was taken or created.

A.17.2 RT Image IOD entity-relationship model

The E-R model for the RT Image IOD is illustrated in Figure A.17-1.

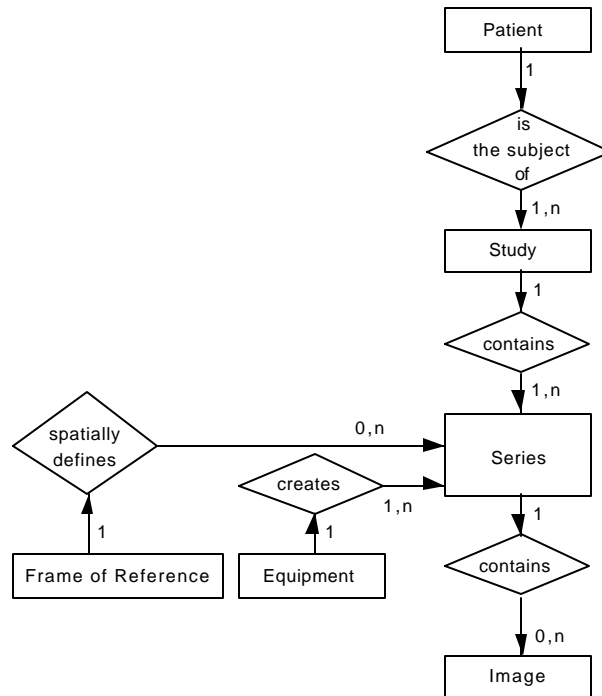

Figure A.17-1—DICOM RT Image IOD information model

A.17.3 RT Image IOD Module Table

Table A.17.3-1—RT IMAGE IOD MODULES

IE	Module	Reference	Usage
Patient	Patient	C.7.1.1	M
Study	General Study	C.7.2.1	M
	Patient Study	C.7.2.2	U
Series	RT Series	C.8.8.1	M
Frame of Reference	Frame of Reference	C.7.4.1	U
Equipment	General Equipment	C.7.5.1	M
Image	General Image	C.7.6.1	M
	Image Pixel	C.7.6.3	M
	Contrast/bolus	C.7.6.4	C-Required if contrast media was used in this image.
	Cine	C.7.6.5	C - Required if multi-frame image is a cine image.
	Multi-Frame	C.7.6.6	C - Required if pixel data is multi-frame data.
	RT Image	C.8.8.2	M
	Modality LUT	C.11.1	U
	VOI LUT	C.11.2	U
	Approval	C.8.8.16	U
	Curve	C.10.2	U
	Audio	C.10.3	U
SOP Common	C.12.1	M	

- Notes:
1. The inclusion of the Multi-Frame module allows for the expression of time-dependent image series or multiple exposures of identical beam geometries (i.e. multiple exposure portal images). If a time-dependent series of images (such as port images or DRRs) is represented the Cine module is used to indicate this. This would subsequently allow analysis of patient movement during treatment. Multiple exposure images allow individual images of treatment ports and open field ports to be grouped into a single multi-frame image.
 2. The Modality LUT module has been included to allow the possibility of conversion between portal image pixel values and dose transmitted through the patient. The VOI LUT module has been included to allow the possibility of translation between stored pixel values (after the Modality LUT has been applied if specified) and display levels.
 3. The Curve module has been included to allow the possibility of storing one or more curves overlaid with a given image. Generally these curves would represent patient structures, target volumes, or beam limiting device (collimator) openings, although they could also be used to store other data such as axis information. Such curves would be stored in pixel units (i.e. the coordinates would represent pixel indices in the image data). For example, patient structures might have the following attribute assignments:

Curve Dimensions (50xx,0005)	= 2
Number of Points (50xx,0010)	= Number of data points in curve
Type of Data (50xx,0020)	= ROI
Data Value Representation (50xx,0103)	= US (unsigned short)
Curve Data (50xx,3000)	= (x,y) pixel coordinates
Curve Description (50xx,0022)	= Structure/Target name

Note that there is no facility for representing multi-frame curves (i.e. all curves are interpreted as being related to the first image frame in a multi-frame image). Curves other than patient structures might also be represented using the HIST, POLY or TABL curve types (see C.10.2.1).

4. The Equipment module contains information describing the equipment used to acquire or generate the RT Image (such as a portal imager, conventional simulator or treatment planning system). However, the equipment attributes in the RT Image module describe the equipment on which the treatment has been or will be given, typically an electron accelerator.

5. For RT Images which contain no relevant pixel data, such as BEV images without DRR information, Pixel Data (7FE0,0010) should be filled with a sequence of zeros.

6. The Frame of Reference module has been included to allow the indication of spatial association of two or more RT Image instances (e.g. where the images have been acquired in the same frame of reference, or have been resampled to share the same frame of reference). If the Frame of Reference occurs within a SOP Instance within a given series, then all SOP Instances within that series will be spatially related. For example, two RT Images may share the same Frame of Reference if they are located on the same physical plane, as determined by the treatment machine Gantry Angle (300A,011E) and source to image plane distance specified by RT Image SID (3002,0026).

A.18 RT DOSE INFORMATION OBJECT DEFINITION

A.18.1 RT Dose IOD Description

The focus for this Radiotherapy Dose IOD (RT Dose IOD) is to address the requirements for transfer of dose distributions calculated by radiotherapy treatment planning systems. These distributions may be represented as 2D or 3D grids, as isodose curves, or as named or unnamed dose points scattered throughout the volume. This IOD may also contain dose-volume histogram data, single or multi-frame overlays, audio annotations, and application-defined lookup tables. This IOD does not provide for definition of doses in beam or other coordinate systems. The application is responsible for transforming data in other, non-patient based coordinate systems to the patient based coordinate system described in C.7.6.2.1.1.

A.18.2 RT Dose IOD entity-relationship model

The E-R model for the RT Dose IOD is illustrated in Figure A.18-1.

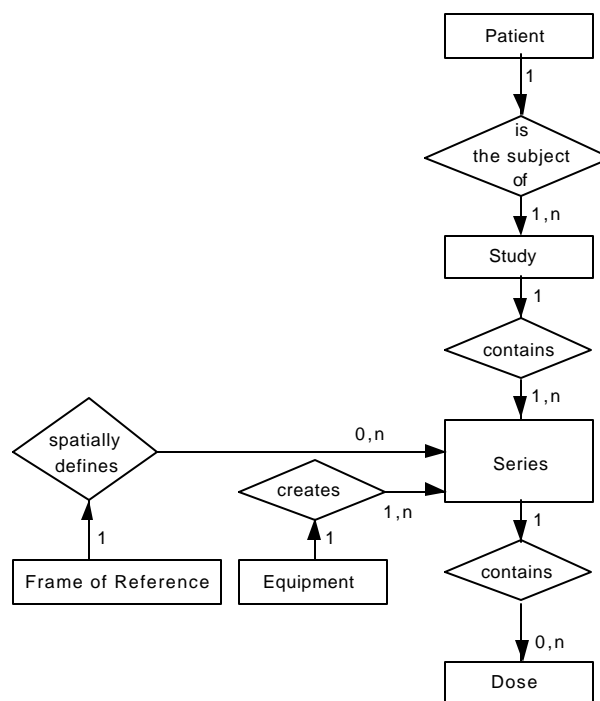

Figure A.18-1—DICOM RT Dose IOD information model

A.18.3 RT Dose IOD Module Table

Table A.18.3-1—RT DOSE IOD MODULES

IE	Module	Reference	Usage
Patient	Patient	C.7.1.1	M
Study	General Study	C.7.2.1	M
	Patient Study	C.7.2.2	U
Series	RT Series	C.8.8.1	M
Frame of Reference	Frame of Reference	C.7.4.1	M
Equipment	General Equipment	C.7.5.1	M
Dose	General Image	C.7.6.1	C - Required if dose data contains grid-based doses.
	Image Plane	C.7.6.2	C - Required if dose data contains grid-based doses.
	Image Pixel	C.7.6.3	C - Required if dose data contains grid-based doses.
	Multi-Frame	C.7.6.6	C - Required if dose data contains grid-based doses and pixel data is multi-frame data.
	Overlay Plane	C.9.2	U
	Multi-Frame Overlay	C.9.3	U
	Modality LUT	C.11.1	U
	RT Dose	C.8.8.3	M
	RT DVH	C.8.8.4	U
	Structure Set	C.8.8.5	C - Required if dose data contains dose points or isodose curves
	ROI Contour	C.8.8.6	C - Required if dose data contains dose points or isodose curves
	RT Dose ROI	C.8.8.7	C - Required if dose data contains dose points or isodose curves
	Audio	C.10.3	U
SOP Common	C.12.1	M	

- Notes:
1. Within the RT Dose IOD, the RT Dose module supports 2D and 3D dose grids. The Structure Set, ROI Contour and RT Dose ROI modules together support isodose curves and points, and the RT DVH module supports dose-volume histogram data. They are not mutually exclusive: all four representations may be included in a single instance of the object or they may be included in any combination. Product Conformance Statements should clearly state which of these mechanisms is supported and under what conditions.
 2. The RT Dose IOD has been defined as a composite IOD, separate from the RT Plan IOD. This has been done for the following reasons:
 - to allow for the multiplicity of possible dose calculations using beam models for the same basic plan,

- to avoid undesirable transmission of large amounts of data with the treatment plan, and
- to accommodate the fact that CT Simulation and other “beam geometry” generating devices which use the RT Plan IOD do not have or require access to this data, either for transmission or storage.

A.19 RT STRUCTURE SET INFORMATION OBJECT DEFINITION

A.19.1 RT Structure Set IOD Description

The focus for this Radiotherapy Structure Set IOD (RT Structure Set IOD) is to address the requirements for transfer of patient structures and related data defined on CT scanners, virtual simulation workstations, treatment planning systems and similar devices. This IOD may also contain audio curve annotations.

A.19.2 RT Structure Set IOD entity-relationship model

The E-R model for the RT Structure Set IOD is illustrated in Figure A.19-1.

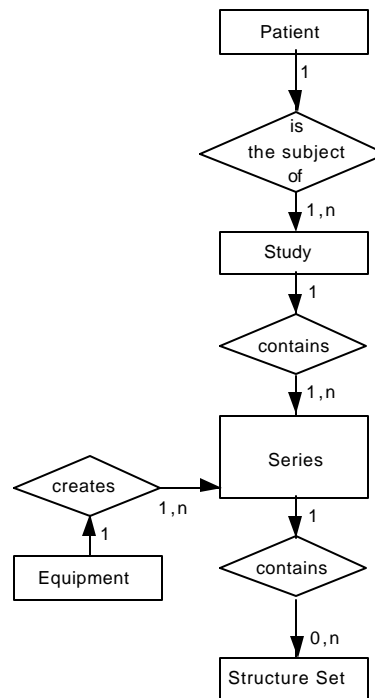

Figure A.19-1—DICOM RT Structure Set IOD information model

A.19.3 RT Structure Set IOD Module Table**Table A.19.3-1—RT STRUCTURE SET IOD MODULES**

IE	Module	Reference	Usage
Patient	Patient	C.7.1.1	M
Study	General Study	C.7.2.1	M
	Patient Study	C.7.2.2	U
Series	RT Series	C.8.8.1	M
Equipment	General Equipment	C.7.5.1	M
Structure Set	Structure Set	C.8.8.5	M
	ROI Contour	C.8.8.6	M
	RT ROI Observations	C.8.8.8	M
	Approval	C.8.8.16	U
	Audio	C.10.3	U
	SOP Common	C.12.1	M

A.20 RT PLAN INFORMATION OBJECT DEFINITION

A.20.1 RT Plan IOD Description

The focus for this Radiotherapy Plan IOD (RT Plan IOD) is to address the requirements for transfer of treatment plans generated by manual entry, a virtual simulation system, or a treatment planning system before or during a course of treatment. Such plans may contain fractionation information, and define external beams and/or brachytherapy application setups. This IOD may also contain audio curve annotations.

A.20.2 RT Plan IOD entity-relationship model

The E-R model for the RT Plan IOD is illustrated in Figure A.20-1.

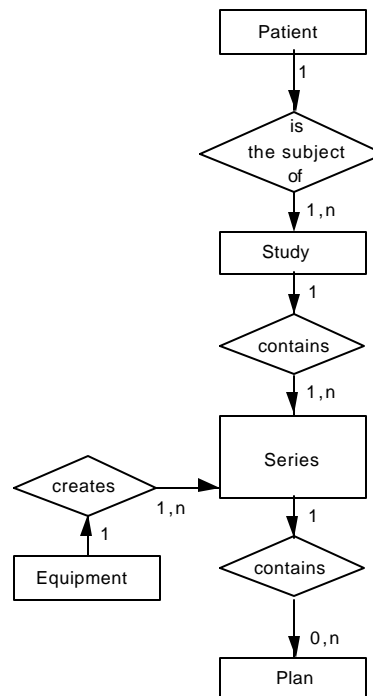

Figure A.20-1—DICOM RT Plan IOD information model

A.20.3 RT Plan IOD Module Table

Table A.20.3-1—RT PLAN IOD MODULES

IE	Module	Reference	Usage
Patient	Patient	C.7.1.1	M
Study	General Study	C.7.2.1	M
	Patient Study	C.7.2.2	U
Series	RT Series	C.8.8.1	M
Equipment	General Equipment	C.7.5.1	M
Plan	RT General Plan	C.8.8.9	M
	RT Prescription	C.8.8.10	U
	RT Tolerance Tables	C.8.8.11	U
	RT Patient Setup	C.8.8.12	U
	RT Fraction Scheme	C.8.8.13	U
	RT Beams	C.8.8.14	C - Required if RT Fraction Scheme Module exists and Number of Beams (300A,0080) is greater than zero for one or more fraction groups
	RT Brachy Application Setups	C.8.8.15	C - Required if RT Fraction Scheme Module exists and Number of Brachy Application Setups (300A,00A0) is greater than zero for one or more fraction groups
	Approval	C.8.8.16	U
	Audio	C.10.3	U
	SOP Common	C.12.1	M

A.20.3.1 RT FRACTION SCHEME MODULE

The RT Fraction Scheme module is structured to be used together with the RT Beams or RT Brachy Application Setups module. If beams are referenced in the RT Fraction Scheme module, all such beams shall be included in the RT Beams module if it is present. Similarly, if brachy application setups are referenced in the RT Fraction Scheme module, all such setups shall be included in the RT Brachy Application Setups module if it is present. However, the RT Fraction Scheme module can be used without the RT Beams or RT Brachy Application Setups modules if no beams or brachy application setups are referenced, and the RT Beams or RT Brachy Application Setups modules can also be used without the RT Fraction Scheme module if no fraction scheme information is available.

A.20.3.2 RT PRESCRIPTION MODULE

The RT Prescription module provides for the inclusion of dose prescription information pertinent to the complete plan, which may comprise several fraction schemes, themselves consisting of many beams.

A.20.3.3 RT TOLERANCE TABLES MODULE

The RT Tolerance Tables module provides information concerning machine tolerances as they apply to the whole treatment plan. Tolerances are applied by reference to a tolerance table within the RT Tolerance Tables module for beams contained within the RT Beams module.

A.20.3.4 RT PATIENT SETUP MODULE

The RT Patient Setup module provides information concerning patient setup parameters and fixation devices as they apply to the whole treatment plan. Patient setup information within the RT Patient Setup module is referenced by beams contained within the RT Beams module.

A.21 POSITRON EMISSION TOMOGRAPHY IMAGE INFORMATION OBJECT DEFINITION

A.21.1 PET Image IOD Description

The Positron Emission Tomography (PET) Image Information Object Definition specifies an image which has been created by a Positron Tomograph imaging device, including dedicated PET cameras and Nuclear Medicine imaging devices operating in coincidence mode. This includes data created by external detection devices which create images of the distribution of administered radioactive materials, specifically positron emitters, in the body. Depending on the specific radiopharmaceuticals administered and the particular imaging procedure performed, problems involving changes in metabolism, function, or physiology can be investigated and various region pathologies can be studied. For these problems, quantitation of image data in absolute activity and physiological units is important. In addition, the PET Image IOD specifies attenuation (transmission) images used for correction and anatomical reference of emission images.

A.21.2 PET Image IOD Entity-Relationship Model

The E-R model in Section A.1.2 of this part depicts those components of the DICOM Information Model which directly reference the PET Image IOD. The overlay IE, modality LUT IE, VOI LUT IE, and curve IE are not components of the PET Image IOD.

A.21.3 PET Image IOD Module Table

Table A.21.3-1 - PET IMAGE IOD MODULES

IE	Module	Reference	Usage
Patient	Patient	C.7.1.1	M
Study	General Study	C.7.2.1	M
	Patient Study	C.7.2.2	U
Series	General Series	C.7.3.1	M
	PET Series	C.8.9.1	M
	PET Isotope	C.8.9.2	M
	PET Multi-gated Acquisition	C.8.9.3	C - Required if Series Type (0054,1000) Value 1 is GATED.
	NM/PET Patient Orientation	C.8.4.6	M
Frame of Reference	Frame of Reference	C.7.4.1	M
Equipment	General Equipment	C.7.5.1	M
Image	General Image	C.7.6.1	M
	Image Plane	C.7.6.2	M
	Image Pixel	C.7.6.3	M
	PET Image	C.8.9.4	M
	Overlay Plane	C.9.2	U
	VOI LUT	C.11.2	U
	SOP Common	C.12.1	M

A.22 STANDALONE PET CURVE INFORMATION OBJECT DEFINITION

A.22.1 Standalone PET Curve IOD Description

A standalone PET curve IOD is the specification of a PET curve which may be related to an image, but also may have its own existence within a PET Series.

A.22.2 Standalone PET Curve IOD Entity-Relationship Model

The E-R model in Section A.1.2 of this part depicts those components of the DICOM Information Model which directly reference the standalone PET curve IOD. The frame of reference IE, overlay IE, modality LUT IE, VOI LUT IE and Image IE are not components of the standalone PET curve IOD.

A.22.3 Standalone PET Curve IOD Module Table

Table A.22.3-1 - STANDALONE PET CURVE IOD MODULES

IE	Module	Reference	Usage
Patient	Patient	C.7.1.1	M
Study	General Study	C.7.2.1	M
	Patient Study	C.7.2.2	U
Series	General Series	C.7.3.1	M
	PET Series	C.8.9.1	M
	PET Isotope	C.8.9.2	M
	PET Multi-gated Acquisition	C.8.9.3	C - Required if Series Type (0054,1000) Value 1 is GATED.
Equipment	General Equipment	C.7.5.1	M
Curve	Curve Identification	C.10.1	M
	Curve	C.10.2	M
	PET Curve	C.8.9.5	M
	SOP Common	C.12.1	M

A.23 STORED PRINT INFORMATION OBJECT DEFINITION

A.23.1 IOD Description

The Stored Print IOD describes all the print parameters to print a single film. The Stored Print IOD contains one or more references to Image SOP Instances. There is a many to one relationship between the Stored Print IOD and the Printer IOD.

Images referenced by the Stored Print IOD shall be Preformatted Grayscale or Preformatted Color Images or other grayscale images where all grayscale transformations up to and including VOI LUT have been applied.

A.23.2 Stored Print IOD Entity-Relationship Model

The E-R Model in Section A.1.2 depicts those components of the DICOM Information Model which directly reference the Stored Print IOD. The Frame of Reference IE, Overlay IE, Curve IE, VOI LUT IE, and Modality LUT IE are not components of the Stored Print IOD.

A.23.3 IOD Module Table

**Table A.23-1
STORED PRINT IOD MODULES**

IE	Module	Reference	Usage
Patient	Patient	C.7.1.1	M
Study	General Study	C.7.2.1	M
	Patient Study	C.7.2.2	U
Series	General Series	C.7.3.1	M
Equipment	General Equipment	C.7.5.1	M
	Printer Characteristics	C.16.1	M
Image	Film Box	C.16.2	M
	Image Box List	C.16.3	M
	Annotation List	C.16.4	U
	Image Overlay Box List	C.16.5	U
	Presentation LUT List	C.16.6	U
	SOP Common Information	C.12.1	M

A.24 HARDCOPY GRAYSCALE IMAGE INFORMATION OBJECT DEFINITION

A.24.1 IOD Description

The Hardcopy Grayscale IOD is an abstraction of a printable 8 or 12 bit grayscale image where annotation, overlays, graphics may be burned in and where the LUT operations up to and including VOI LUT have already been performed.

- Notes:
1. A hardcopy grayscale image corresponds with a Preformatted Grayscale Image (see PS 3.4) and is a specialization of the Secondary Capture Image.
 2. The optional Annotation List and Image Overlay Box Modules in the Stored Print IOD provide additional overlay, graphic, and annotation information that will be burnt into the printed image only if both the SCU and SCP support the Attributes in these Modules. See the Pull Print Request N-CREATE Behavior Section in PS 3.4.

A.24.2 Hardcopy Grayscale Image IOD Entity-Relationship Model

The E-R Model in Section A.1.2 depicts those components of the DICOM Information Model which are related to the Hardcopy Grayscale Image IOD.

A.24.3 IOD Module Table

**Table A.24-1
HARDCOPY GRAYSCALE IMAGE IOD MODULES**

IE	Module	Reference	Usage
Patient	Patient	C.7.1.1	M
Study	General Study	C.7.2.1	M
	Patient Study	C.7.2.2	U
Series	General Series	C.7.3.1	M
Equipment	General Equipment	C.7.5.1	U
	Hardcopy Equipment	C.8.10.1	M
Image	General Image	C.7.6.1	M
	HC Grayscale Image	C.8.10.2	M
	SOP Common Information	C.12.1	M

The Overlay Plane Module (C.9.2) was previously in this IOD. Its use in this IOD has been retired. See PS 3.3-1998.

A.25 HARDCOPY COLOR IMAGE INFORMATION OBJECT DEFINITION

A.25.1 IOD Description

The Hardcopy Color IOD is an abstraction of a printable 8 bit color image where annotation, overlays, and graphics may be burned in.

Note : A hardcopy color image corresponds with a Preformatted Color Image (see PS 3.4) and is a specialization of the Secondary Capture Image.

A.25.2 Hardcopy Color Image IOD Entity-Relationship Model

The E-R Model in Section A.1.2 depicts those components of the DICOM Information Model which are related to the Hardcopy Color Image IOD.

A.25.3 IOD Module Table

**Table A.25-1
HARDCOPY COLOR IMAGE IOD MODULES**

IE	Module	Reference	Usage
Patient	Patient	C.7.1.1	M
Study	General Study	C.7.2.1	M
	Patient Study	C.7.2.2	U
Series	General Series	C.7.3.1	M
Equipment	General Equipment	C.7.5.1	U
	Hardcopy Equipment	C.8.10.1	M
Image	General Image	C.7.6.1	M
	HC Color Image	C.8.10.3	M
	SOP Common Information	C.12.1	M

The Overlay Plane Module (C.9.2) was previously in this IOD. Its use in this IOD has been retired. See PS 3.3-1998.

A.26 DIGITAL X-RAY IMAGE INFORMATION OBJECT DEFINITION

A.26.1 DX Image IOD Description

The Digital X-Ray (DX) Image Information Object Definition specifies an image which has been created by a digital projection radiography imaging device.

- Notes:
1. This includes but is not limited to: chest radiography, linear and multi-directional tomography, orthopantomography and skeletal radiography. Acquisition of image data may include but is not limited to: CCD-based sensors, stimulable phosphor imaging plates, amorphous selenium, scintillation based amorphous silicon and secondary capture of film-based images.
 2. Specific IODs are defined for intra-oral radiography and mammography that further specialize the DX IOD.

A DX image shall consist of the result of a single X-Ray exposure, in order to ensure that the anatomical and orientation attributes are meaningful for the image, permitting safe annotation, appropriate image processing and appropriate dissemination.

- Notes:
1. This requirement specifically deprecates the common film/screen and Computed Radiography practice of making multiple exposures on different areas of a cassette or plate by using lead occlusion between exposures. Such acquisitions could be separated and transformed into multiple DX images during an appropriate quality assurance step by an operator.
 2. This requirement does not deprecate the acquisition of multiple paired structures during a single exposure, provided that they can be described by the relevant orientation Attributes. For example, an AP or PA projection of both hands side by side is typically obtained in a single exposure, and can be described by a Patient Orientation (0020,0020) of R\H or L\H since both hands are in the same traditional Anatomical Position. See Annex E.

The DX Image IOD is used in two SOP Classes as defined in PS 3.4 Storage Service Class, a SOP Class for storage of images intended for presentation, and a SOP Class for storage of images intended for further processing before presentation. These are distinguished by their SOP Class UID and by the Enumerated Value of the mandatory Attribute in the DX Series Module, Presentation Intent Type (0008,0068).

A.26.2 DX Image IOD Entity-Relationship Model

The E-R Model in Section A.1.2 depicts those components of the DICOM Information Model which directly reference the DX Image IOD.

A.26.3 DX Image IOD Module Table

**Table A.26-1
DIGITAL X-RAY IMAGE IOD MODULES**

IE	Module	Reference	Usage
Patient	Patient	C.7.1.1	M
	Specimen Identification	C.7.1.2	U
Study	General Study	C.7.2.1	M

	Patient Study	C.7.2.2	U
Series	General Series	C.7.3.1	M
	DX Series	C.8.11.1	M
Frame of Reference	Frame of Reference	C.7.4.1	U
Equipment	General Equipment	C.7.5.1	M
Image	General Image	C.7.6.1	M
	Image Pixel	C.7.6.3	M
	Contrast/Bolus	C.7.6.4	U
	Display Shutter	C.7.6.11	U
	Device	C.7.6.12	U
	Therapy	C.7.6.13	U
	DX Anatomy Imaged	C.8.11.2	M
	DX Image	C.8.11.3	M
	DX Detector	C.8.11.4	M
	X-Ray Collimator	C.8.7.3	U
	DX Positioning	C.8.11.5	U
	X-Ray Tomo Acquisition	C.8.7.7	U
	X-Ray Acquisition Dose	C.8.7.8	U
	X-Ray Generation	C.8.7.9	U
	X-Ray Filtration	C.8.7.10	U
	X-Ray Grid	C.8.7.11	U
	Overlay Plane	C.9.2	C - Required if graphic annotation is present - See A.26.4
	Curve	C.10.2	U
	VOI LUT	C.11.2	C - Required if Presentation Intent Type (0008,0068) is FOR PRESENTATION. Shall not be present otherwise. See Note 8.
	Image Histogram	C.11.5	U
Acquisition Context	C.7.6.14	M	
SOP Common	C.12.1	M	

Notes: 1. The Overlay Plane requirement is determined by the presence of "graphic annotation". Graphic annotation includes user or machine drawn graphics or text (such as computer assisted diagnosis) to indicate regions of interest or descriptions. It specifically does not include patient or image identification or technique information that is defined in other Attributes of the IOD..

2. The Device and Therapy Modules are User optional, though it is desirable that, if present, they are stored by an SCP. It is recognized that in some cases the digital image acquisition system will not have a user interface or direct connection that allows acquisition of these parameters, even if device or therapy have been used.
3. The Frame of Reference, X-Ray Collimator, DX Positioner and DX Tomo Acquisition Modules are User optional, though it is desirable that, if present, they are stored by an SCP. It is recognized that in some cases the parameters of the mechanical devices used for collimation, positioning and tomography may not be available to a digital image acquisition system that is not integrated with the X-Ray generation and positioning system.
4. The Acquisition Context Module is mandatory, but may be empty. The intent is that all Storage SCPs will preserve any information present, without requiring acquisition systems to be required to generate any contents, or requiring display systems to use the information for annotation (which is beyond the scope of DICOM).
5. Expectations on what an SCP of a SOP Class based on this IOD will store may be determined by evaluating a Conformance Statement of the form defined in PS 3.2 that specifies the level of conformance to the Storage SOP Classes as defined in PS 3.4. For example, Level 2 (Full) conformance indicates that all standard and optional attributes will be stored and may be accessed.
6. The Histogram Module may contain a single or multiple statistical representations of the pixel data used to derive the VOI LUT Module, or intended to be used to derive or replace the VOI LUT Module. The Histogram Module may contain statistics of a subset of the stored image pixel data (such as from a cropped area or region of interest that is not the full field of view) that are useful for deriving a better VOI LUT than might be derived from the statistics obtained from the entire stored pixel data.
7. The Specimen Identification Module is User optional, because although its Attributes may be helpful for identification and correlation with Pathology Information Systems, much specimen radiography, including forensic radiography, is performed with conventional clinical X-Ray equipment which is not likely to support specific specimen identification features.
8. The VOI LUT Module Attributes and behaviour are further specialized in the DX Image Module.

A.26.4 Overlay Plane Module

If the Overlay Plane Module is present, any Overlays defined in that Module shall store the overlay data in Overlay Data (60xx,3000), and not any unused high bits in Pixel Data (7FE0,0010).

A.27 DIGITAL MAMMOGRAPHY X-RAY IMAGE INFORMATION OBJECT DEFINITION

A.27.1 Digital Mammography X-Ray Image IOD Description

The Digital Mammography X-Ray Image Information Object Definition specifies an image which has been created by a digital mammography projection radiography imaging device.

Note: It meets all of the requirements of the DX IOD in A.26 in addition to those specified in this section.

The Digital Mammography Image IOD is used in two SOP Classes as defined in PS 3.4 Storage Service Class, a SOP Class for storage of images intended for presentation, and a SOP Class for storage of images intended for further processing before presentation. These are distinguished by their SOP Class UID and by the Enumerated Value of the mandatory Attribute in the DX Series Module, Presentation Intent Type (0008,0068).

A.27.2 Digital Mammography X-Ray Image IOD Module Table

Table A.27-1
DIGITAL MAMMOGRAPHY X-RAY IMAGE IOD MODULES

IE	Module	Reference	Usage
Patient	Patient	C.7.1.1	M
	Specimen Identification	C.7.1.2	U
Study	General Study	C.7.2.1	M
	Patient Study	C.7.2.2	U
Series	General Series	C.7.3.1	M
	DX Series	C.8.11.1	M
	Mammography Series	C.8.11.6	M
Frame of Reference	Frame of Reference	C.7.4.1	C - Required if multiple images are obtained without releasing breast compression
Equipment	General Equipment	C.7.5.1	M
Image	General Image	C.7.6.1	M
	Image Pixel	C.7.6.3	M
	Contrast/Bolus	C.7.6.4	U
	Display Shutter	C.7.6.11	U
	Device	C.7.6.12	U
	Therapy	C.7.6.13	U
	DX Anatomy Imaged	C.8.11.2	M
	DX Image	C.8.11.3	M
	DX Detector	C.8.11.4	M
	X-Ray Collimator	C.8.7.3	U
	DX Positioning	C.8.11.5	U
	X-Ray Tomo Acquisition	C.8.7.7	U
	X-Ray Acquisition Dose	C.8.7.8	U
	X-Ray Generation	C.8.7.9	U
	X-Ray Filtration	C.8.7.10	U
	X-Ray Grid	C.8.7.11	U
	Mammography Image	C.8.11.7	M
	Overlay Plane	C.9.2	C - Required if graphic annotation is present - See A.27.3
	Curve	C.10.2	U
	VOI LUT	C.11.2	C - Required if Presentation Intent Type (0008,0068) is FOR PRESENTATION. Shall not be present otherwise.
Image Histogram	C.11.5	U	

	Acquisition Context	C.7.6.14	M
	SOP Common	C.12.1	M

A.27.3 Overlay Plane Module

If the Overlay Plane Module is present, any Overlays defined in that Module shall store the overlay data in Overlay Data (60xx,3000), and not any unused high bits in Pixel Data (7FE0,0010).

A.28 DIGITAL INTRA-ORAL X-RAY IMAGE INFORMATION OBJECT DEFINITION

A.28.1 Digital Intra-oral X-Ray Image IOD Description

The Digital Intra-oral X-Ray Image Information Object Definition specifies an image that has been created by an intra-oral projection radiography imaging device.

Note: It meets all of the requirements of the DX IOD in A.26 in addition to those specified in this section.

The Digital Intra-oral X-Ray Image IOD is used in two SOP Classes as defined in PS 3.4 Storage Service Class, a SOP Class for storage of images intended for presentation, and a SOP Class for storage of images intended for further processing before presentation. These are distinguished by their SOP Class UID and by the Enumerated Value of the mandatory Attribute in the DX Series Module, Presentation Intent Type (0008,0068).

A.28.2 Digital Intra-oral X-Ray Image IOD Module Table

Table A.28-1
DIGITAL INTRA-ORAL X-RAY IMAGE IOD MODULES

IE	Module	Reference	Usage
Patient	Patient	C.7.1.1	M
	Specimen Identification	C.7.1.2	U
Study	General Study	C.7.2.1	M
	Patient Study	C.7.2.2	U
Series	General Series	C.7.3.1	M
	DX Series	C.8.11.1	M
	Intra-oral Series	C.8.11.8	M
Frame of Reference	Frame of Reference	C.7.4.1	U
Equipment	General Equipment	C.7.5.1	M
Image	General Image	C.7.6.1	M
	Image Pixel	C.7.6.3	M
	Contrast/Bolus	C.7.6.4	U
	Display Shutter	C.7.6.11	U
	Device	C.7.6.12	U
	Therapy	C.7.6.13	U
	DX Anatomy Imaged	C.8.11.2	M
	DX Image	C.8.11.3	M
	DX Detector	C.8.11.4	M
	X-Ray Collimator	C.8.7.3	U
	DX Positioning	C.8.11.5	U
	X-Ray Tomo Acquisition	C.8.7.7	U
	X-Ray Acquisition Dose	C.8.7.8	U
	X-Ray Generation	C.8.7.9	U
	X-Ray Filtration	C.8.7.10	U
X-Ray Grid	C.8.7.11	U	

Intra-oral Image	C.8.11.9	M
Overlay Plane	C.9.2	C - Required if graphic annotation is present - See A.28.3
Curve	C.10.2	U
VOI LUT	C.11.2	C - Required if Presentation Intent Type (0008,0068) is FOR PRESENTATION. Shall not be present otherwise.
Image Histogram	C.11.5	U
Acquisition Context	C.7.6.14	M
SOP Common	C.12.1	M

A.28.3 Overlay Plane Module

If the Overlay Plane Module is present, any Overlays defined in that Module shall store the overlay data in Overlay Data (60xx,3000), and not any unused high bits in Pixel Data (7FE0,0010).

A.29 RT BEAMS TREATMENT RECORD INFORMATION OBJECT DEFINITION

A.29.1 RT Beams Treatment Record IOD Description

The focus for this Radiotherapy Beams Treatment Record IOD (RT Beams Treatment Record IOD) is to address the requirements for transfer of treatment session reports generated by a treatment verification system during a course of external beam treatment, with optional cumulative summary information. It may also be used for transfer of treatment information during delivery.

A.29.2 RT Beams Treatment Record IOD entity-relationship model

The E-R model for the RT Beams Treatment Record IOD is illustrated in Figure A.29-1.

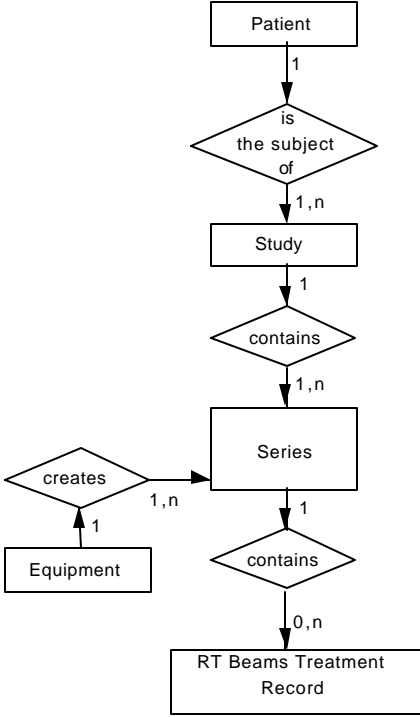

Figure A.29-1—DICOM RT Beams Treatment Record IOD information model

A.29.3 RT Beams Treatment Record IOD Module Table

Table A.29.3-1—RT Beams Treatment Record IOD Modules

IE	Module	Reference	Usage
Patient	Patient	C.7.1.1	M
Study	General Study	C.7.2.1	M
	Patient Study	C.7.2.2	U
Series	RT Series	C.8.8.1	M
Equipment	General Equipment	C.7.5.1	M
Treatment Record	RT General Treatment Record	C.8.8.17	M
	RT Patient Setup	C.8.8.12	U
	RT Treatment Machine Record	C.8.8.18	M
	Measured Dose Reference Record	C.8.8.19	U
	Calculated Dose Reference Record	C.8.8.20	U
	RT Beams Session Record	C.8.8.21	M
	RT Treatment Summary Record	C.8.8.23	U
	Curve	C.10.2	U
	SOP Common	C.12.1	M

A.30 RT BRACHY TREATMENT RECORD INFORMATION OBJECT DEFINITION

A.30.1 RT Brachy Treatment Record IOD Description

The focus for this Radiotherapy Brachy Treatment Record IOD (RT Brachy Treatment Record IOD) is to address the requirements for transfer of treatment session reports generated by a treatment verification system during a course of Brachytherapy treatment, with optional cumulative summary information. It may also be used for transfer of treatment information during delivery.

A.30.2 RT Brachy Treatment Record IOD entity-relationship model

The E-R model for the RT Brachy Treatment Record IOD is illustrated in Figure A.Y-1.

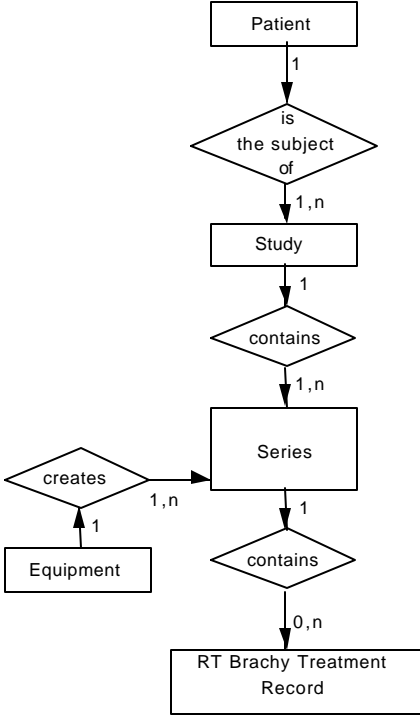

Figure A.30-1—DICOM RT Brachy Treatment Record IOD information model

A.30.3 RT Brachy Treatment Record IOD Module Table

Table A.30.3-1—RT Brachy Treatment Record IOD Modules

IE	Module	Reference	Usage
Patient	Patient	C.7.1.1	M
Study	General Study	C.7.2.1	M
	Patient Study	C.7.2.2	U
Series	RT Series	C.8.8.1	M
Equipment	General Equipment	C.7.5.1	M
Treatment Record	RT General Treatment Record	C.8.8.17	M
	RT Patient Setup	C.8.8.12	U
	RT Treatment Machine Record	C.8.8.18	M
	Measured Dose Reference Record	C.8.8.19	U
	Calculated Dose Reference Record	C.8.8.20	U
	RT Brachy Session Record	C.8.8.22	M
	RT Treatment Summary Record	C.8.8.23	U
	Curve	C.10.2	U
	SOP Common	C.12.1	M

A.31 RT TREATMENT SUMMARY RECORD INFORMATION OBJECT DEFINITION

A.31.1 RT Treatment Summary Record IOD Description

The focus for this Radiotherapy Treatment Summary Record IOD (RT Treatment Summary Record IOD) is to address the requirements for transfer of cumulative summary information, normally generated at the completion of a course of treatment.

A.31.2 RT Treatment Summary Record IOD entity-relationship model

The E-R model for the RT Treatment Summary Record IOD is illustrated in Figure A.31-1.

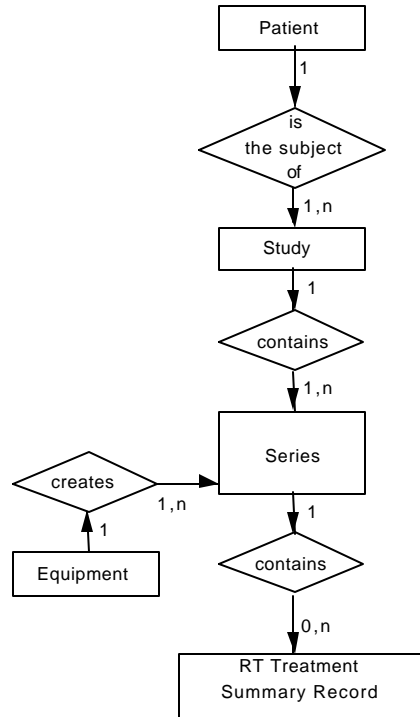

Figure A.31-1—DICOM RT Treatment Summary Record IOD information model

A.31.3 RT Treatment Summary Record IOD Module Table

Table A.31.3-1—RT Treatment Summary Record IOD Modules

IE	Module	Reference	Usage
Patient	Patient	C.7.1.1	M
Study	General Study	C.7.2.1	M
	Patient Study	C.7.2.2	U
Series	RT Series	C.8.8.1	M
Equipment	General Equipment	C.7.5.1	M
Treatment Record	RT General Treatment Record	C.8.8.17	M
	RT Treatment Summary Record	C.8.8.23	M
	Curve	C.10.2	U
	SOP Common	C.12.1	M

A.32 VISIBLE LIGHT IMAGE INFORMATION OBJECT DEFINITIONS

A.32.1 VL Endoscopic Image Information Object Definition

A.32.1.1 VL Endoscopic Image IOD Description

The VL Endoscopic Image IOD specifies the Attributes of Single-frame VL Endoscopic Images.

A.32.1.2 VL Endoscopic Image IOD Entity-Relationship Model

The E-R Model in Section A.1.2 of this Part depicts those components of the DICOM Information Model which directly reference the VL Endoscopic Image IOD, with exception of the Curve, VOI LUT, Frame of Reference and Modality LUT entities which are not used. Additionally, Image in figure A.1.2 of PS3.3 represents a Single Frame image. A frame denotes a two-dimensional organization of pixels recorded as a single exposure. Table A.32.1-1 specifies the Modules of the VL Endoscopic Image IOD.

- Notes:
1. An endoscopic procedure might include multiple series of single frame endoscopic images as well as one or more additional series of related diagnostic images. The procedure might involve multiple Performed Procedure Steps, multiple endoscopes, and multiple anatomic regions and might be supervised, performed, and/or interpreted by one or more individuals.
 2. Several distinct diagnostic or therapeutic processes might occur during an endoscopic procedure. For example: Endoscopic examination of duodenal mucosa, biopsy, lavage, or biliary stone removal.

**Table A.32.1-1
VL ENDOSCOPIC IMAGE IOD MODULES**

IE	Module	Reference	Usage
Patient	Patient	C.7.1.1	M
Study	General Study	C.7.2.1	M
	Patient Study	C.7.2.2	U
Series	General Series	C.7.3.1	M
Equipment	General Equipment	C.7.5.1	M
Image	General Image	C.7.6.1	M
	Image Pixel	C.7.6.3	M
	Acquisition Context	C.7.6.14	M
	VL Image	C.8.12.1	M
	Overlay Plane	C.9.2	U
	SOP Common	C.12.1	M

A.32.1.3 VL Endoscopic Image IOD Content Constraints

A.32.1.3.1 Modality

The value of Modality (0008,0060) shall be ES.

A.32.2 VL Microscopic Image Information Object Definition

A.32.2.1 VL Microscopic Image IOD Description

The VL Microscopic Image IOD specifies the Attributes of Single-frame VL Microscopic Images. Slide Coordinates shall not be encoded with this IOD.

A.32.2.2 VL Microscopic Image IOD Entity-Relationship Model

The E-R Model in Section A.1.2 of this Part depicts those components of the DICOM Information Model which directly reference the VL Microscopic Image IOD, with exception of the Curve, VOI LUT, Frame of Reference and Modality LUT entities which are not used. Additionally, Image in figure A.1.2 of PS3.3 represents a Single Frame image. A frame denotes a two-dimensional organization

of pixels recorded as a single exposure. Table A.32.1-2 specifies the Modules of the VL Microscopic Image IOD.

- Notes:
1. A microscopy procedure might include multiple series of single frame VL Microscopic Images as well as one or more additional series of related diagnostic images. The procedure might involve multiple Performed Procedure Steps, multiple microscopes, and multiple anatomic regions and might be supervised, performed, and/or interpreted by one or more individuals.
 2. Several distinct diagnostic or therapeutic processes might occur during a single procedure. For example: Histologic staining of the same section with multiple special stains.

Table A.32.1-2
VL MICROSCOPIC IMAGE IOD MODULES

IE	Module	Reference	Usage
Patient	Patient	C.7.1.1	M
	Specimen Identification	C.7.1.2	M
Study	General Study	C.7.2.1	M
	Patient Study	C.7.2.2	U
Series	General Series	C.7.3.1	M
Equipment	General Equipment	C.7.5.1	M
Image	General Image	C.7.6.1	M
	Image Pixel	C.7.6.3	M
	Acquisition Context	C.7.6.14	M
	VL Image	C.8.12.1	M
	Overlay Plane	C.9.2	U
	SOP Common	C.12.1	M

A.32.2.3 VL Microscopic Image IOD Content Constraints

A.32.2.3.1 Modality

The value of Modality (0008,0060) shall be GM.

A.32.3 VL Slide-Coordinates Microscopic Image Information Object Definition

A.32.3.1 VL Slide-Coordinates Microscopic Image IOD Description

The VL Slide-Coordinates Microscopic Image IOD specifies the Attributes of VL Single-frame Slide-Coordinates Microscopic Images.

A.32.3.2 VL Slide-Coordinates Microscopic Image IOD Entity-Relationship Model

The E-R Model in Section A.1.2 of this Part depicts those components of the DICOM Information Model which directly reference the VL Slide-Coordinates Microscopic Image IOD, with exception of the Curve, VOI LUT, Frame of Reference and Modality LUT entities which are not used. Additionally, Image in figure A.1.2 of PS3.3 represents a Single Frame image. A frame denotes a two-dimensional organization of pixels recorded as a single exposure. Table A.32.1-3 specifies the Modules of the VL Slide-Coordinates Microscopic Image IOD.

- Notes:
1. A microscopic imaging procedure might include multiple series of single frame Microscopic Images as well as one or more additional series of related diagnostic images and might involve multiple Performed Procedure Steps, multiple Microscopes, and multiple anatomic regions. The procedure might be supervised, performed, and/or interpreted by one or more individuals.
 2. Several distinct diagnostic or therapeutic processes might occur during a single procedure. For example: Histologic staining of the same section with multiple special stains.

**Table A.32.1-3
VL SLIDE-COORDINATES MICROSCOPIC IMAGE IOD MODULES**

IE	Module	Reference	Usage
Patient	Patient	C.7.1.1	M
	Specimen Identification	C.7.1.2	M
Study	General Study	C.7.2.1	M
	Patient Study	C.7.2.2	U
Series	General Series	C.7.3.1	M
	Frame of Reference	C.7.4.1	M
Equipment	General Equipment	C.7.5.1	M
Image	General Image	C.7.6.1	M
	Image Pixel	C.7.6.3	M
	Acquisition Context	C.7.6.14	M
	VL Image	C.8.12.1	M
	Slide Coordinates	C.8.12.2	M
	Overlay Plane	C.9.2	U
	SOP Common	C.12.1	M

A.32.3.3 VL Slide-Coordinates Microscopic Image IOD Content Constraints

A.32.3.3.1 Modality

The value of Modality (0008,0060) shall be SM.

A.32.4 VL Photographic Image Information Object Definition

A.32.4.1 VL Photographic Image IOD Description

The VL Photographic Image IOD specifies the attributes of VL Single-frame photographic Images.

A.32.4.2 VL Photographic Image IOD Entity-Relationship Model

The E-R Model in Section A.1.2 of this Part depicts those components of the DICOM Information Model which directly reference the VL Photographic Image IOD, with exception of the Curve, VOI LUT, Frame of Reference and Modality LUT entities which are not used. Additionally, Image in figure A.1.2 of PS3.3 represents a Single Frame image. A frame denotes a two-dimensional organization of pixels recorded as a single exposure. Table A.32.4-1 specifies the Modules of the VL Photographic Image IOD.

- Notes:
1. A VL photographic imaging procedure might include multiple series of single frame VL Photographic images as well as one or more additional series of related diagnostic images. The procedure might involve multiple Performed Procedure Steps, multiple cameras, and multiple anatomic regions and might be supervised, performed, and/or interpreted by one or more individuals.
 2. Several distinct diagnostic or therapeutic processes might occur during a single procedure.

Table A.32.4-1
VL PHOTOGRAPHIC IMAGE IOD MODULES

IE	Module	Reference	Usage
Patient	Patient	C.7.1.1	M
	Specimen Identification	C.7.1.2	C - Required if the Imaging Subject is a Specimen
Study	General Study	C.7.2.1	M
	Patient Study	C.7.2.2	U
Series	General Series	C.7.3.1	M
Equipment	General Equipment	C.7.5.1	M
Image	General Image	C.7.6.1	M
	Image Pixel	C.7.6.3	M
	Acquisition Context	C.7.6.14	M
	VL Image	C.8.12.1	M
	Overlay Plane	C.9.2	U
	SOP Common	C.12.1	M

A.32.4.3 VL Photographic Image IOD Content Constraints

A.32.4.3.1 Modality

The value of Modality (0008,0060) shall be XC.

A.33 GRAYSCALE SOFTCOPY PRESENTATION STATE INFORMATION OBJECT DEFINITION

A.33.1 Grayscale Softcopy Presentation State IOD Description

The Grayscale Softcopy Presentation State Information Object Definition (IOD) specifies information that may be used to present (display) images that are referenced from within the IOD.

It includes capabilities for specifying:

- a. the output grayscale space in P-Values
- b. grayscale contrast transformations including modality and VOI LUT
- c. mask subtraction for multi-frame images
- d. selection of the area of the image to display and whether to rotate or flip it
- e. image and display relative annotations, including graphics, text and overlays

A.33.2 Grayscale Softcopy Presentation State IOD Module Table

**Table A.33-1
Grayscale Softcopy Presentation State IOD MODULES**

IE	Module	Reference	Usage
Patient	Patient	C.7.1.1	M
Study	General Study	C.7.2.1	M
	Patient Study	C.7.2.2	U
Series	General Series	C.7.3.1	M
	Presentation Series	C.11.9	M
Equipment	General Equipment	C.7.5.1	M
Presentation State	Presentation State	C.11.10	M
	Mask	C.7.6.10	C - Required if the referenced image(s) are multi-frame and are to be subtracted
	Display Shutter	C.7.6.11	C - Required if a Display Shutter is to be applied to referenced image(s) and the Bitmap Display Shutter Module is not present
	Bitmap Display Shutter	C.7.6.15	C - Required if a Display Shutter is to be applied to referenced image(s) and the Display Shutter Module is not present
	Overlay Plane	C.9.2	C - Required if Overlay is to be applied to referenced image(s) or the Bitmap Display Shutter Module is present
	Overlay/Curve Activation	C.11.7	C- Required if referenced image contains curve or overlay data which is to be displayed
	Displayed Area	C.10.4	M
	Graphic Annotation	C.10.5	C - Required if Graphic Annotations are to be applied to referenced image(s)
	Spatial Transformation	C.10.6	C - Required if rotation, flipping or magnification are to be applied to referenced image(s)
	Graphic Layer	C.10.7	C - Required if Graphic Annotations or Overlays or Curves are to be applied to referenced image(s)
	Modality LUT	C.11.1	C - Required if a Modality LUT

			is to be applied to referenced image(s)
	Softcopy VOI LUT	C.11.8	C - Required if a VOI LUT is to be applied to referenced image(s)
	Softcopy Presentation LUT	C.11.6	M
	SOP Common	C.12.1	M

In the Grayscale Softcopy Presentation State IOD, the Presentation Series Module specializes some Attributes of the General Series Module, and the Presentation State Module specializes some Attributes of the Mask and Display Shutter Modules.

- Notes:
1. Subtraction between different images is not supported.
 2. The Mask Module condition implies that it need not be supported by an SCP that supports presentation states only for single frame image storage SOP Classes, or instances of multi-frame image Storage SOP Classes that contain only one frame.
 3. The Display Shutter may be used to darken image areas that surround important information and exclude extraneous bright areas that increase glare and ambient lighting impairing image interpretation. For example, unexposed areas in a CR image might be obscured using the Display Shutter, rather than permanently replacing image pixels in those areas.
 4. This IOD does not support the storage of a multi-frame overlay in the IOD itself, but does support selective activation of multi-frame overlays within the referenced images via the Overlay/Curve Activation Module.

A.34 WAVEFORM INFORMATION OBJECT DEFINITIONS

A.34.1 Waveform IOD Entity-Relationship Model

The Waveform E-R Model is shown in Figure A.34-1. This model applies to a variety of Waveform IODs.

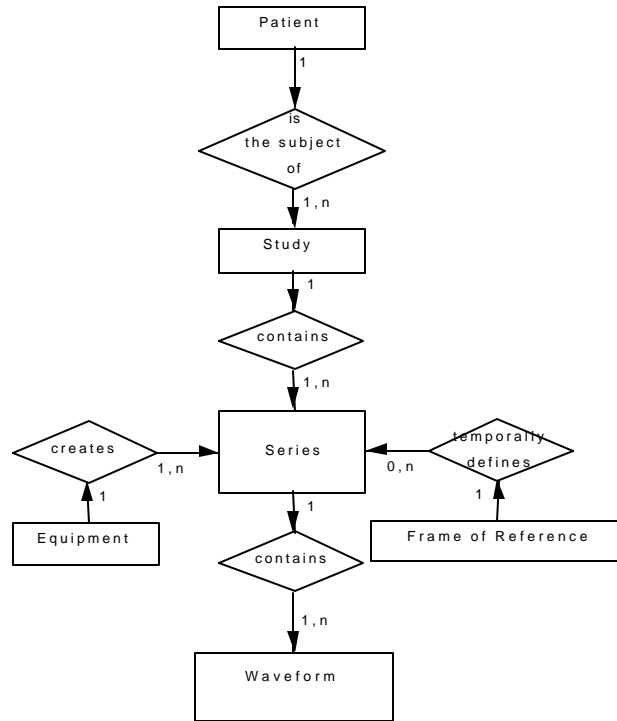

Figure A.34-1
DICOM Waveform IOD Information Model

A.34.2 Basic Voice Audio Information Object Definition

A.34.2.1 Basic Voice Audio IOD Description

The Basic Voice Audio IOD is the specification of a digitized sound which has been acquired or created by an audio modality or by an audio acquisition function within an imaging modality. A typical use is report dictation.

A.34.2.2 Basic Voice Audio IOD Entity-Relationship Model

The E-R Model in Section A.34.1 of this Part applies to the Basic Voice Audio IOD.

A.34.2.3 Basic Voice Audio IOD Module Table

Table A.34.2-1
Basic Voice Audio IOD Modules

IE	Module	Reference	Usage
Patient	Patient	C.7.1.1	M
Study	General Study	C.7.2.1	M
	Patient Study	C.7.2.2	U

Series	General Series	C.7.3.1	M
Frame of Reference	Synchronization	C.7.4.2	U
Equipment	General Equipment	C.7.5.1	M
Waveform	Waveform Identification	C.10.8	M
	Waveform	C.10.9	M
	Acquisition Context	C.7.6.14	M
	Waveform Annotation	C.10.10	U
	SOP Common	C.12.1	M

A.34.2.4 Basic Voice Audio IOD Content Constraints

A.34.2.4.1 Modality

The value of Modality (0008,0060) shall be AU.

A.34.2.4.2 Waveform Sequence

The number of Waveform Sequence (5400,0100) Items shall be one.

A.34.2.4.3 Number of Waveform Channels

The value of the Number of Waveform Channels (003A,0005) in the Waveform Sequence Item shall be 1 or 2.

A.34.2.4.4 Sampling Frequency

The value of the Sampling Frequency (003A,001A) in the Waveform Sequence Item shall be 8000.

A.34.2.4.5 Waveform Sample Interpretation

The value of the Waveform Sample Interpretation (5400,1006) in the Waveform Sequence Item shall be UB, MB, or AB.

A.34.3 12-Lead Electrocardiogram Information Object Definition

A.34.3.1 12-Lead ECG IOD Description

The 12-Lead Electrocardiogram (12-Lead ECG) IOD is the specification of digitized electrical signals from the patient cardiac conduction system collected on the body surface, which has been acquired by an ECG modality or by an ECG acquisition function within an imaging modality.

A.34.3.2 12-Lead ECG IOD Entity-Relationship Model

The E-R Model in Section A.34.1 of this Part applies to the 12-Lead ECG IOD.

A.34.3.3 12-Lead ECG IOD Module Table

**Table A.34.3-1
12-Lead ECG IOD Modules**

IE	Module	Reference	Usage
Patient	Patient	C.7.1.1	M
Study	General Study	C.7.2.1	M
	Patient Study	C.7.2.2	U

Series	General Series	C.7.3.1	M
Frame of Reference	Synchronization	C.7.4.2	U
Equipment	General Equipment	C.7.5.1	M
Waveform	Waveform Identification	C.10.8	M
	Waveform	C.10.9	M
	Acquisition Context	C.7.6.14	M
	Waveform Annotation	C.10.10	C – required if annotation is present
	SOP Common	C.12.1	M

A.34.3.4 12-Lead ECG IOD Content Constraints

A.34.3.4.1 Modality

The value of Modality (0008,0060) shall be ECG.

A.34.3.4.2 Acquisition Context Module

For SOP Instances of ECG acquired in the cardiac catheterization lab, the Defined Template for Acquisition Context Sequence (0040,0555) is TID 3403. For routine resting or stress ECG, the Defined Template for Acquisition Context Sequence (0040,0555) is TID 3401.

A.34.3.4.3 Waveform Sequence

The number of Waveform Sequence (5400,0100) Items shall be between 1 and 5, inclusive.

A.34.3.4.4 Number of Waveform Channels

The value of the Number of Waveform Channels (003A,0005) in each Waveform Sequence Item shall be between 1 and 13, inclusive. The total number of channels encoded across all Items shall not exceed 13.

Note: This specialization provides for up to five Waveform Sequence Items (multiplex groups), with a total of 13 channels. This allows, for instance, encoding of four sets of three simultaneously recorded channels, the sets being acquired sequentially, plus one continuous channel for the duration of the other sets. This can be used to emulate the behavior of classical 12-lead ECG strip chart recorders with 4x3 presentation, plus a continuous lead II recording (see figure).

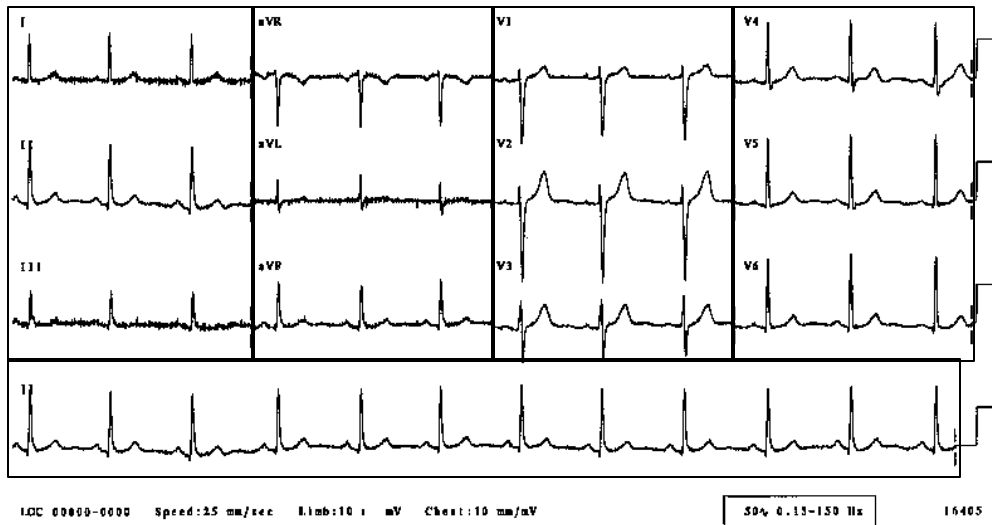

Multiplex Group 1 – leads I, II, III; time offset 0; duration 2.5 s
Multiplex Group 2 – leads aVR, aVL, aVF; time offset 2.5 s; duration 2.5 s
Multiplex Group 3 – leads V1, V2, V3; time offset 5.0 s; duration 2.5 s
Multiplex Group 4 – leads V4, V5, V6; time offset 7.5 s; duration 2.5 s
Multiplex Group 5 – lead II; time offset 0; duration 9.84 s

FIGURE A.34.3-1 12-Lead ECG Example (Informative)

A.34.3.4.5 Number of Waveform Samples

The value of the Number of Waveform Samples (003A,0010) in each Waveform Sequence Item shall be less than or equal to 16384.

Note: This allows over 16 seconds per channel at the maximum sampling frequency; if longer recordings are required, the General ECG IOD may be used.

A.34.3.4.6 Sampling Frequency

The value of the Sampling Frequency (003A,001A) in each Waveform Sequence Item shall be between 200 and 1000, inclusive.

A.34.3.4.7 Channel Source

The Baseline Context ID for the Channel Source Sequence (003A,0208) in each Channel Definition Sequence Item shall be CID 3001.

A.34.3.4.8 Waveform Sample Interpretation

The value of the Waveform Sample Interpretation (5400,1006) in each Waveform Sequence Item shall be SS.

A.34.3.4.9 Waveform Annotation Module

The Defined Context ID for the Concept Name Code Sequence (0040,A043) in the Waveform Annotation Sequence (0040,B020) shall be CID 3335. This Context Group supports the annotation of suppressed pacemaker spikes in the ECG waveform.

A.34.4 General Electrocardiogram Information Object Definition

A.34.4.1 General ECG IOD Description

The General Electrocardiogram (ECG) IOD is the specification of digitized electrical signals from the patient cardiac conduction system collected on the body surface, which has been acquired by an ECG modality or by an ECG acquisition function within an imaging modality.

A.34.4.2 General ECG IOD Entity-Relationship Model

The E-R Model in Section A.34.1 of this Part applies to the General ECG IOD.

A.34.4.3 General ECG IOD Module Table

**Table A.34.4-1
General ECG IOD Modules**

IE	Module	Reference	Usage
Patient	Patient	C.7.1.1	M
Study	General Study	C.7.2.1	M
	Patient Study	C.7.2.2	U
Series	General Series	C.7.3.1	M
Frame of Reference	Synchronization	C.7.4.2	U
Equipment	General Equipment	C.7.5.1	M
Waveform	Waveform Identification	C.10.8	M
	Waveform	C.10.9	M
	Acquisition Context	C.7.6.14	M
	Waveform Annotation	C.10.10	C – required if annotation is present
	SOP Common	C.12.1	M

A.34.4.4 General ECG IOD Content Constraints

A.34.4.4.1 Modality

The value of Modality (0008,0060) shall be ECG.

A.34.4.4.2 Waveform Sequence

The number of Waveform Sequence (5400,0100) Items shall be between 1 and 4, inclusive.

A.34.4.4.3 Number of Waveform Channels

The value of the Number of Waveform Channels (003A,0005) in each Waveform Sequence Item shall be between 1 and 24, inclusive.

A.34.4.4.4 Sampling Frequency

The value of the Sampling Frequency (003A,001A) in each Waveform Sequence Item shall be between 200 and 1000, inclusive.

A.34.4.4.5 Channel Source

The Defined Context ID for the Channel Source Sequence (003A,0208) in each Channel Definition Sequence Item shall be CID 3001.

Note: Terms from other Context Groups may also be used for extended specification of the Channel Source, as declared in the Conformance Statement for an application (see PS3.2).

A.34.4.4.6 Waveform Sample Interpretation

The value of the Waveform Sample Interpretation (5400,1006) in each Waveform Sequence Item shall be SS.

A.34.4.4.7 Waveform Annotation Module

The Defined Context ID for the Concept Name Code Sequence (0040,A043) in the Waveform Annotation Sequence (0040,B020) shall be CID 3335. This Context Group supports the annotation of suppressed pacemaker spikes in the ECG waveform.

A.34.5 Ambulatory Electrocardiogram Information Object Definition

A.34.5.1 Ambulatory ECG IOD Description

The Ambulatory Electrocardiogram (ECG) IOD is the specification of digitized electrical signals from the patient cardiac conduction system collected on the body surface, which has been acquired by an ambulatory electrocardiography (Holter) device.

Note: The duration of acquisition represented in one SOP Instance is not specifically constrained, and is limited only by the maximum size of the Waveform Data attribute.

A.34.5.2 Ambulatory ECG IOD Entity-Relationship Model

The E-R Model in Section A.34.1 of this Part applies to the Ambulatory ECG IOD.

A.34.5.3 Ambulatory ECG IOD Module Table

**Table A.34.5-1
Ambulatory ECG IOD Modules**

IE	Module	Reference	Usage
Patient	Patient	C.7.1.1	M
Study	General Study	C.7.2.1	M
	Patient Study	C.7.2.2	U
Series	General Series	C.7.3.1	M
Frame of Reference	Synchronization	C.7.4.2	U
Equipment	General Equipment	C.7.5.1	M
Waveform	Waveform Identification	C.10.8	M
	Waveform	C.10.9	M
	Acquisition Context	C.7.6.14	U
	Waveform Annotation	C.10.10	C – required if annotation is present
	SOP Common	C.12.1	M

A.34.5.4 Ambulatory ECG IOD Content Constraints

A.34.5.4.1 Modality

The value of Modality (0008,0060) shall be ECG.

A.34.5.4.2 Waveform Sequence

The number of Waveform Sequence (5400,0100) Items shall be 1.

A.34.5.4.3 Number of Waveform Channels

The value of the Number of Waveform Channels (003A,0005) in the Waveform Sequence Item shall be between 1 and 12, inclusive.

A.34.5.4.5 Sampling Frequency

The value of the Sampling Frequency (003A,001A) in each Waveform Sequence Item shall be between 50 and 1000, inclusive.

A.34.5.4.6 Channel Source

The Defined Context ID for the Channel Source Sequence (003A,0208) in each Channel Definition Sequence Item shall be CID 3001.

A.34.5.4.7 Waveform Sample Interpretation

The value of the Waveform Sample Interpretation (5400,1006) in each Waveform Sequence Item shall be SB or SS.

A.34.6 Hemodynamic Information Object Definition

A.34.6.1 Hemodynamic IOD Description

The Hemodynamic IOD is the specification of digitized pressure, electrical, and other signals from the patient circulatory system, which has been acquired by a hemodynamic modality.

Note: The duration of acquisition represented in one SOP Instance is not specifically constrained, and is limited only by the maximum size of the Waveform Data attribute.

A.34.6.2 Hemodynamic IOD Entity-Relationship Model

The E-R Model in Section A.34.1 of this Part applies to the Hemodynamic IOD.

A.34.6.3 Hemodynamic IOD Module Table

**Table A.34.6-1
Hemodynamic IOD Modules**

IE	Module	Reference	Usage
Patient	Patient	C.7.1.1	M
Study	General Study	C.7.2.1	M
	Patient Study	C.7.2.2	U
Series	General Series	C.7.3.1	M
Frame of Reference	Synchronization	C.7.4.2	C – Required if Waveform Originality (003A,0004) is ORIGINAL; may be present otherwise

Equipment	General Equipment	C.7.5.1	M
Waveform	Waveform Identification	C.10.8	M
	Waveform	C.10.9	M
	Acquisition Context	C.7.6.14	M
	Waveform Annotation	C.10.10	C – required if annotation is present
	SOP Common	C.12.1	M

A.34.6.4 Hemodynamic IOD Content Constraints

A.34.6.4.1 Modality

The value of Modality (0008,0060) shall be HD.

A.34.6.4.2 Acquisition Context Module

The Defined Template for Acquisition Context Sequence (0040,0555) is TID 3403.

A.34.6.4.3 Waveform Sequence

The number of Waveform Sequence (5400,0100) Items shall be between 1 and 4, inclusive.

A.34.6.4.4 Number of Waveform Channels

The value of the Number of Waveform Channels (003A,0005) in each Waveform Sequence Item shall be between 1 and 8, inclusive.

A.34.6.4.5 Sampling Frequency

The value of the Sampling Frequency (003A,001A) in each Waveform Sequence Item shall be less than or equal to 400.

A.34.6.4.7 Channel Source

The Defined Context ID for the Channel Source Sequence (003A,0208) in each Channel Definition Sequence Item shall be CID 3003, CID 3001 for surface ECG channels, or CID 3090 for time synchronization channels. The Channel Source Code Value shall encode at minimum the metric (measured physical quality) and function (measurement or stimulus); unless otherwise specifically encoded, the default function shall be “measurement”.

The Channel Source Modifiers Sequence (003A,0209) in each Channel Definition Sequence Item shall be used to specify additional qualifiers of the semantics of the waveform source, including technique and anatomic location, if not encoded by the Channel Source Code Value. Technique, with terms from Defined Context ID 3241, shall be specified in Channel Source Modifiers Sequence Items prior to the cardiac anatomic location(s), with terms from Defined Context ID 3010, 3014, and 3019. If technique is pullback, the sequence of anatomic locations shall be specified in ordered Channel Source Modifiers Sequence Items (e.g., initial, transitional, and final locations).

Note: Terms from other Context Groups may also be used for extended specification of the Channel Source, as declared in the Conformance Statement for an application (see PS3.2).

A.34.6.4.8 Waveform Sample Interpretation

The value of the Waveform Sample Interpretation (5400,1006) in each Waveform Sequence Item shall be SS.

A.34.6.4.9 Waveform Annotation Module

The Defined Context ID for the Concept Name Code Sequence (0040,A043) in the Waveform Annotation Sequence (0040,B020) shall be CID 3337.

A.34.7 Basic Cardiac Electrophysiology Information Object Definition

A.34.7.1 Basic Cardiac EP IOD Description

The Basic Cardiac Electrophysiology IOD is the specification of digitized electrical signals from the patient cardiac conduction system collected in the heart, which has been acquired by an EP modality.

Note: The duration of acquisition represented in one SOP Instance is not specifically constrained, and is limited only by the maximum size of the Waveform Data attribute.

A.34.7.2 Basic Cardiac EP IOD Entity-Relationship Model

The E-R Model in Section A.34.1 of this Part applies to the Cardiac EP IOD.

A.34.7.3 Basic Cardiac EP IOD Module Table

**Table A.34.7-1
Basic Cardiac EP IOD Modules**

IE	Module	Reference	Usage
Patient	Patient	C.7.1.1	M
Study	General Study	C.7.2.1	M
	Patient Study	C.7.2.2	U
Series	General Series	C.7.3.1	M
Frame of Reference	Synchronization	C.7.4.2	C – Required if Waveform Originality (003A,0004) value is ORIGINAL; may be present otherwise
Equipment	General Equipment	C.7.5.1	M
Waveform	Waveform Identification	C.10.8	M
	Waveform	C.10.9	M
	Acquisition Context	C.7.6.14	M
	Waveform Annotation	C.10.10	C – required if annotation is present
	SOP Common	C.12.1	M

A.34.7.4 Basic Cardiac EP IOD Content Constraints

A.34.7.4.1 Modality

The value of Modality (0008,0060) shall be EPS.

A.34.7.4.2 Acquisition Context Module

The Defined Template for Acquisition Context Sequence (0040,0555) is TID 3450.

A.34.7.4.3 Waveform Sequence

The number of Waveform Sequence (5400,0100) Items shall be between 1 and 4, inclusive.

A.34.7.4.4 Sampling Frequency

The value of the Sampling Frequency (003A,001A) in each Waveform Sequence Item shall be less than or equal to 2000.

A.34.7.4.5 Channel Source

The Defined Context ID for the Channel Source Sequence (003A,0208) in each Channel Definition Sequence Item shall be CID 3011. The Channel Source Code Value shall encode at minimum the anatomic location of the channel source.

The Channel Source Modifiers Sequence (003A,0209) in each Channel Definition Sequence Item shall be used to specify additional qualifiers of the semantics of the waveform source, including metric (measured physical quality), function (measurement or stimulus), and technique from Defined Context ID 3240, and anatomic location qualifiers from Defined Context ID 3019, if not encoded by the Channel Source Code Value. If not explicitly encoded, the default metric and function shall be "voltage measurement". If a differential signal is used, that shall be indicated in a Modifier Item, and the positive pole and negative pole identified in the subsequent two modifiers.

- Notes:
1. Terms from other Context Groups may also be used for extended specification of the Channel Source, as declared in the Conformance Statement for an application (see PS3.2).
 2. A differential signal from the high right atrium , where electrode 1 on the catheter is the positive pole and electrode 3 the negative pole, could be specified by coded terms meaning:
Channel Source: "High Right Atrium"
Channel Source Modifiers: "Differential", "E1", "E3"
(Implicit default modifier: "Voltage Measurement")

A.34.7.4.6 Waveform Sample Interpretation

The value of the Waveform Sample Interpretation (5400,1006) in each Waveform Sequence Item shall be SS.

A.34.7.4.7 Waveform Annotation Module

The Defined Context ID for the Concept Name Code Sequence (0040,A043) in the Waveform Annotation Sequence (0040,B020) shall be CID 3339.

A.35 STRUCTURED REPORT DOCUMENT INFORMATION OBJECT DEFINITIONS

A.35.1 Basic Text SR Information Object Definition

A.35.1.1 Basic Text SR Information Object Description

The Basic Text Structured Report (SR) IOD is intended for the representation of reports with minimal usage of coded entries (typically used in Document Title and headings) and a hierarchical tree of headings under which may appear text and subheadings. Reference to SOP Instances (e.g. images or waveforms or other SR Documents) is restricted to appear at the level of the leaves of this primarily textual tree. This structure simplifies the encoding of conventional textual reports as SR Documents, as well as their rendering.

A.35.1.2 Basic Text SR IOD Entity-Relationship Model

The E-R Model in Section A.1.2 of this Part applies to the Basic Text SR IOD. The Frame of Reference IE, and the IEs at the level of the Image IE in Section A.1.2 are not components of the Basic Text SR IOD. Table A.35.1-1 specifies the Modules of the Basic Text SR IOD.

A.35.1.3 Basic Text SR IOD Module Table

Table A.35.3-1 specifies the Modules of the Basic Text SR IOD.

**Table A.35.1-1
BASIC TEXT SR IOD MODULES**

IE	Module	Reference	Usage
Patient	Patient	C.7.1.1	M
	Specimen Identification	C.7.1.2	C - Required if the Observation Subject is a Specimen
Study	General Study	C.7.2.1	M
	Patient Study	C.7.2.2	U
Series	SR Document Series	C.17.1	M
Equipment	General Equipment	C.7.5.1	M
Document	SR Document General	C.17.2	M
	SR Document Content	C.17.3	M
	SOP Common	C.12.1	M

A.35.1.3.1 Basic Text SR IOD Content Constraints

A.35.1.3.1.1 Value Type

Value Type (0040,A040) in the Content Sequence (0040,A730) of the SR Document Content Module is constrained to the following Enumerated Values (see Table C.17.3-1 for Value Type definitions):

TEXT
CODE
DATETIME
DATE
TIME
UIDREF
PNAME
COMPOSITE
IMAGE

WAVEFORM
CONTAINER

A.35.1.3.1.2 Relationship Constraints

Relationships between Content Items in the content of this IOD shall be conveyed in the by-value mode. See Table C.17.3-2 for Relationship Type definitions.

Note: Relationships by-reference are forbidden. Therefore, Referenced Content Item Identifier (0040,DB73) is not present in any of the Content Items within the SR Document Content Module.

Table A.35.1-2 specifies the relationship constraints of this IOD.

**Table A.35.1-2
RELATIONSHIP CONTENT CONSTRAINTS FOR BASIC TEXT SR IOD**

Source Value Type	Relationship Type (Enumerated Values)	Target Value Type
CONTAINER	CONTAINS	TEXT, CODE, DATETIME, DATE, TIME, UIDREF, PNAME, COMPOSITE ¹ , IMAGE ¹ , WAVEFORM ¹ , CONTAINER
CONTAINER	HAS OBS CONTEXT	TEXT, CODE, DATETIME, DATE, TIME, UIDREF, PNAME
CONTAINER, IMAGE ¹ , WAVEFORM ¹ , COMPOSITE ¹	HAS ACQ CONTEXT	TEXT, CODE, DATETIME, DATE, TIME, UIDREF, PNAME
any type	HAS CONCEPT MOD	TEXT, CODE ²
TEXT	HAS PROPERTIES	TEXT, CODE, DATETIME, DATE, TIME, UIDREF, PNAME, IMAGE ¹ , WAVEFORM ¹ , COMPOSITE ¹
TEXT	INFERRED FROM	TEXT, CODE, DATETIME, DATE, TIME, UIDREF, PNAME, IMAGE ¹ , WAVEFORM ¹ , COMPOSITE ¹

Note: 1. Which SOP Classes the IMAGE, WAVEFORM or COMPOSITE Value Type may refer to, is documented in the Conformance Statement for an application (see PS 3.2 and PS 3.4).
2. The HAS CONCEPT MOD relationship is used to modify the meaning of the Concept Name of a Source Content Item, for example to provide a more descriptive explanation, a different language translation, or to define a post-coordinated concept.

A.35.2 Enhanced SR Information Object Definition

A.35.2.1 Enhanced SR Information Object Description

The Enhanced Structured Report (SR) IOD is a superset of the Basic Text SR IOD. It is also intended for the representation of reports with minimal usage of coded entries (typically Document Title and headings) and a hierarchical tree of headings under which may appear text and subheadings. In addition, it supports the use of numeric measurements with coded measurement names and units. Reference to SOP Instances (e.g. images or waveforms or SR Documents) is restricted to appear at the level of the leaves of this primarily textual tree. It enhances references to

SOP Instances with spatial regions of interest (points, lines, circle, ellipse, etc.) and temporal regions of interest .

A.35.2.2 Enhanced SR IOD Entity-Relationship Model

The E-R Model in Section A.1.2 of this Part applies to the Enhanced SR IOD. The Frame of Reference IE, and the IEs at the level of the Image IE in Section A.1.2 are not components of the Enhanced SR IOD. Table A.35.2-1 specifies the Modules of the Enhanced SR IOD.

A.35.2.3 Enhanced SR IOD Module Table

**Table A.35.2-1
ENHANCED SR IOD MODULES**

IE	Module	Reference	Usage
Patient	Patient	C.7.1.1	M
	Specimen Identification	C.7.1.2	C - Required if the Observation Subject is a Specimen
Study	General Study	C.7.2.1	M
	Patient Study	C.7.2.2	U
Series	SR Document Series	C.17.1	M
Equipment	General Equipment	C.7.5.1	M
Document	SR Document General	C.17.2	M
	SR Document Content	C.17.3	M
	SOP Common	C.12.1	M

A.35.2.3.1 Enhanced SR IOD Content Constraints

A.35.2.3.1.1 Value Type

Value Type (0040,A040) in the Content Sequence (0040,A730) of the SR Document Content Module is constrained to the following Enumerated Values (see Table C.17.3-1 for Value Type definitions):

- TEXT
- CODE
- NUM
- DATETIME
- DATE
- TIME
- UIDREF
- PNAME
- SCOORD
- TCOORD
- COMPOSITE
- IMAGE
- WAVEFORM
- CONTAINER

A.35.2.3.1.2 Relationship Constraints

Relationships between Content Items in the content of this IOD shall be conveyed in the by-value mode. See Table C.17.3-2 for Relationship Type definitions.

Note: Relationships by-reference are forbidden. Therefore, Referenced Content Item Identifier (0040,DB73) is not present in any of the Content Items within the SR Document Content Module.

Table A.35.2-2 specifies the relationship constraints of this IOD.

**Table A.35.2-2
RELATIONSHIP CONTENT CONSTRAINTS FOR ENHANCED SR IOD**

Source Value Type	Relationship Type (Enumerated Values)	Target Value Type
CONTAINER	CONTAINS	TEXT, CODE, NUM, DATETIME, DATE, TIME, UIDREF, PNAME, SCOORD, TCOORD, COMPOSITE ¹ , IMAGE ¹ , WAVEFORM ¹ , CONTAINER
CONTAINER	HAS OBS CONTEXT	TEXT, CODE, NUM, DATETIME, DATE, TIME, UIDREF, PNAME
CONTAINER, IMAGE ¹ , WAVEFORM ¹ , COMPOSITE ¹	HAS ACQ CONTEXT	TEXT, CODE, NUM, DATETIME, DATE, TIME, UIDREF, PNAME
any type	HAS CONCEPT MOD	TEXT, CODE ²
TEXT	HAS PROPERTIES	TEXT, CODE, NUM, DATETIME, DATE, TIME, UIDREF, PNAME, IMAGE ¹ , WAVEFORM ¹ , COMPOSITE ¹ , SCOORD, TCOORD
TEXT	INFERRED FROM	TEXT, CODE, NUM, DATETIME, DATE, TIME, UIDREF, PNAME, IMAGE ¹ , WAVEFORM ¹ , COMPOSITE ¹ , SCOORD, TCOORD
SCOORD	SELECTED FROM	IMAGE ¹
TCOORD	SELECTED FROM	SCOORD, IMAGE ¹ , WAVEFORM ¹

Note: 1. Which SOP Classes the IMAGE, WAVEFORM or COMPOSITE Value Type may refer to, is documented in the Conformance Statement for an application (see PS 3.2 and PS 3.4).
2. The HAS CONCEPT MOD relationship is used to modify the meaning of the Concept Name of a Source Content Item, for example to provide a more descriptive explanation, a different language translation, or to define a post-coordinated concept.

A.35.3 Comprehensive SR Information Object Definition

A.35.3.1 Comprehensive SR Information Object Description

The Comprehensive SR IOD is a superset of the Basic Text SR IOD and the Enhanced SR IOD, which specifies a class of documents, the content of which may include textual and a variety of coded information, numeric measurement values, references to the SOP Instances and spatial or temporal regions of interest within such SOP Instances. Relationships by-reference are enabled between Content Items.

A.35.3.2 Comprehensive SR IOD Entity-Relationship Model

The E-R Model in Section A.1.2 of this Part applies to the Comprehensive SR IOD. The Frame of Reference IE, and the IEs at the level of the Image IE in Section A.1.2 are not components of the Comprehensive SR IOD. Table A.35.3-1 specifies the Modules of the Comprehensive SR IOD.

A.35.3.3 Comprehensive SR IOD Module Table

**Table A.35.3-1
COMPREHENSIVE SR IOD MODULES**

IE	Module	Reference	Usage
Patient	Patient	C.7.1.1	M
	Specimen Identification	C.7.1.2	C - Required if the Observation Subject is a Specimen
Study	General Study	C.7.2.1	M
	Patient Study	C.7.2.2	U
Series	SR Document Series	C.17.1	M
Equipment	General Equipment	C.7.5.1	M
Document	SR Document General	C.17.2	M
	SR Document Content	C.17.3	M
	SOP Common	C.12.1	M

A.35.3.3.1 Comprehensive SR IOD Content Constraints

A.35.3.3.1.1 Value Type

Value Type (0040,A040) in the Content Sequence (0040,A730) of the SR Document Content Module is constrained to the following Enumerated Values (see Table C.17.3-1 for Value Type definitions):

TEXT
CODE
NUM
DATETIME
DATE
TIME
UIDREF
PNAME
SCOORD
TCOORD
COMPOSITE
IMAGE
WAVEFORM
CONTAINER

A.35.3.3.1.2 Relationship Constraints

Relationships between content items in the content of this IOD may be conveyed either by-value or by-reference. Table A.35.3-2 specifies the relationship constraints of this IOD. See Table C.17.3-2 for Relationship Type definitions.

**Table A.35.3-2
RELATIONSHIP CONTENT CONSTRAINTS FOR COMPREHENSIVE SR IOD**

Source Value Type	Relationship Type (Enumerated Values)	Target Value Type
CONTAINER	CONTAINS	TEXT, CODE, NUM, DATETIME, DATE, TIME, UIDREF, PNAME, SCOORD, TCOORD, COMPOSITE ¹ , IMAGE ¹ , WAVEFORM ¹ , CONTAINER (See below).
TEXT, CODE, NUM, CONTAINER	HAS OBS CONTEXT	TEXT, CODE, NUM, DATETIME, DATE, TIME, UIDREF, PNAME
CONTAINER, IMAGE ¹ , WAVEFORM ¹ , COMPOSITE ¹	HAS ACQ CONTEXT	TEXT, CODE, NUM, DATETIME, DATE, TIME, UIDREF, PNAME, CONTAINER.
any type	HAS CONCEPT MOD	TEXT, CODE ²
TEXT, CODE, NUM	HAS PROPERTIES	TEXT, CODE, NUM, DATETIME, DATE, TIME, UIDREF, PNAME, IMAGE ¹ , WAVEFORM ¹ , COMPOSITE ¹ , SCOORD, TCOORD, CONTAINER.
TEXT, CODE, NUM	INFERRED FROM	TEXT, CODE, NUM, DATETIME, DATE, TIME, UIDREF, PNAME, IMAGE ¹ , WAVEFORM ¹ , COMPOSITE ¹ , SCOORD, TCOORD, CONTAINER.
SCOORD	SELECTED FROM	IMAGE ¹
TCOORD	SELECTED FROM	SCOORD, IMAGE ¹ , WAVEFORM ¹

- Note:
1. Which SOP Classes the IMAGE, WAVEFORM or COMPOSITE Value Type may refer to, is documented in the Conformance Statement for an application (see PS 3.2 and PS 3.4).
 2. The HAS CONCEPT MOD relationship is used to modify the meaning of the Concept Name of a Source Content Item, for example to provide a more descriptive explanation, a different language translation, or to define a post-coordinated concept.

For relationships conveyed by-reference, Content Items with a Value Type of CONTAINER shall only be the target of relationships other than CONTAINS.

That is, CONTAINS relationships with CONTAINERS may not span by-reference links; containment of directly nested CONTAINERS shall only be conveyed by value.

- Note:
1. It is legal to have a CONTAINS relationship by-reference to a target that is not a CONTAINER, such as a TEXT or CODE, which itself has immediate or distant descendants that are CONTAINERS, which may then subsequently have CONTAINS relationships by value with CONTAINERS.
 2. The intent of this constraint is to prevent the need arising to follow by-reference links to build up a strict CONTAINS hierarchy of CONTAINERS that are used as headings and subheadings of an outline. Otherwise the outline hierarchy could become a more general

graph than a tree, which would be awkward to render. The intent is not to prohibit by-reference relationships to other parts of the tree that may be part of an outline, which is why only the CONTAINS relationship is forbidden in this constraint.

3. These constraints only apply to by-reference relationships. There is no intent to prohibit CONTAINERS from being the target value types of by-value relationships other than CONTAINS. That is why CONTAINERS are indicated as valid target value types of HAS PROPERTIES, INFERRED FROM and HAS ACQ CONTEXT in Table A.35.3-2.

Relationships by-reference to ancestor Content Items are forbidden in this IOD to prevent loops.

A.35.4 Key Object Selection Document Information Object Definition

A.35.4.1 Key Object Selection Document Information Object Description

The Key Object Selection Document IOD is intended for flagging one or more significant images, waveforms, or other composite SOP Instances.

A.35.4.2 Key Object Selection Document IOD Entity-Relationship Model

The E-R Model in Section A.1.2 of this Part applies to the Key Object Selection Document IOD. Table A.35.1-1 specifies the Modules of the Key Object Selection Document IOD.

A.35.4.3 Key Object Selection Document IOD Module Table

Table A.35.4-1 specifies the Modules of the Key Object Selection Document IOD.

**Table A.35.4-1
KEY OBJECT SELECTION DOCUMENT IOD MODULES**

IE	Module	Reference	Usage
Patient	Patient	C.7.1.1	M
	Specimen Identification	C.7.1.2	C - Required if the Observation Subject is a Specimen
Study	General Study	C.7.2.1	M
	Patient Study	C.7.2.2	U
Series	Key Object Document Series	C.17.6.1	M
Equipment	General Equipment	C.7.5.1	M
Document	Key Object Document	C.17.6.2	M
	SR Document Content	C.17.3	M
	SOP Common	C.12.1	M

A.35.4.3.1 Key Object Selection Document IOD Content Constraints

A.35.4.3.1.1 Value Type

Value Type (0040,A040) in the Content Sequence (0040,A730) of the SR Document Content Module is constrained to the following Enumerated Values (see Table C.17.3-1 for Value Type definitions):

TEXT
CODE
UIDREF
PNAME
IMAGE

WAVEFORM
COMPOSITE
CONTAINER

A.35.4.3.1.2 Relationship Constraints

Relationships between Content Items in the content of this IOD shall be conveyed in the by-value mode. See Table C.17.3-2 for Relationship Type definitions.

Note: Relationships by-reference are forbidden. Therefore, Referenced Content Item Identifier (0040,DB73) is not present in any of the Content Items within the SR Document Content Module.

Table A.35.4-2 specifies the relationship constraints of this IOD.

Table A.35.4-2
RELATIONSHIP CONTENT CONSTRAINTS FOR KEY OBJECT SELECTION DOCUMENT IOD

Source Value Type	Relationship Type (Enumerated Values)	Target Value Type
CONTAINER	CONTAINS	TEXT, IMAGE, WAVEFORM, COMPOSITE
CONTAINER	HAS OBS CONTEXT	TEXT, CODE, UIDREF, PNAME
CONTAINER	HAS CONCEPT MOD	CODE

A.35.4.3.1.3 Template Constraints

The document shall be constructed from TID 2010 Key Object Selection invoked at the root node.

A.35.5 Mammography CAD SR Information Object Definition

A.35.5.1 Mammography CAD SR Information Object Description

The Mammography CAD SR IOD is used to convey the detection and analysis results of a mammography CAD device. The content may include textual and a variety of coded information, numeric measurement values, references to the SOP Instances, and spatial regions of interest within such SOP Instances. Relationships by-reference are enabled between Content Items.

A.35.5.2 Mammography CAD SR IOD Entity-Relationship Model

The E-R Model in Section A.1.2 of this Part applies to the Mammography CAD SR IOD. The Frame of Reference IE, and the IEs at the level of the Image IE in Section A.1.2 are not components of the Mammography CAD SR IOD. Table A.35.5-1 specifies the Modules of the Mammography CAD SR IOD.

A.35.5.3 Mammography CAD SR IOD Module Table

Table A.35.5-1 specifies the Modules of the Mammography CAD SR IOD.

Table A.35.5-1
MAMMOGRAPHY CAD SR IOD MODULES

IE	Module	Reference	Usage
Patient	Patient	C.7.1.1	M
	Specimen Identification	C.7.1.2	C - Required if the Observation Subject is a Specimen

Study	General Study	C.7.2.1	M
	Patient Study	C.7.2.2	U
Series	SR Document Series	C.17.1	M
Equipment	General Equipment	C.7.5.1	M
Document	SR Document General	C.17.2	M
	SR Document Content	C.17.3	M
	SOP Common	C.12.1	M

A.35.5.3.1 Mammography CAD SR IOD Content Constraints

A.35.5.3.1.1 Template Constraints

- The document shall be constructed from TID 4000 Mammography CAD Document Root invoked at the root node.
- When a content item sub-tree from a prior document is duplicated by-value, its observation context shall be defined by TID 1001, Observation Context, and its subordinate templates, as described in PS 3.16, DCMR Templates.

Note: All Template and Context Group definitions are located in PS 3.16, DICOM Content Mapping Resource, in the Annexes titled DCMR Templates and DCMR Context Groups, respectively.

A.35.5.3.1.2 Value Type

Value Type (0040,A040) in the Content Sequence (0040,A730) of the SR Document Content Module is constrained to the following Enumerated Values (see Table C.17.3-1 for Value Type definitions):

TEXT
CODE
NUM
DATE
TIME
PNAME
SCOORD
COMPOSITE
IMAGE
CONTAINER

A.35.5.3.1.3 Relationship Constraints

The Mammography CAD SR IOD makes extensive use of by-reference INFERRED FROM and by-reference SELECTED FROM relationships. Other relationships by-reference are forbidden. Table A.35.5-2 specifies the relationship constraints of this IOD. See Table C.17.3-2 for Relationship Type definitions.

**Table A.35.5-2
RELATIONSHIP CONTENT CONSTRAINTS FOR MAMMOGRAPHY CAD SR IOD**

Source Value Type	Relationship Type (Enumerated Values)	Target Value Type
CONTAINER	CONTAINS	CODE, NUM, SCOORD, IMAGE ¹ , CONTAINER.
TEXT, CODE, NUM, CONTAINER	HAS OBS CONTEXT	TEXT, CODE, NUM, DATE, TIME, PNAME, COMPOSITE ¹ .
IMAGE	HAS ACQ CONTEXT	TEXT, CODE, DATE, TIME.
CONTAINER, CODE	HAS CONCEPT MOD	TEXT, CODE ² .
TEXT, CODE	HAS PROPERTIES	TEXT, CODE, NUM, DATE, IMAGE ¹ , SCOORD.
CODE, NUM	INFERRED FROM	CODE, NUM, SCOORD, CONTAINER.
SCOORD	SELECTED FROM	IMAGE ¹ .

- Note:
1. Which SOP Classes the IMAGE or COMPOSITE Value Type may refer to, is documented in the Conformance Statement for an application (see PS 3.2 and PS 3.4).
 2. The HAS CONCEPT MOD relationship is used to modify the meaning of the Concept Name of a Source Content Item, for example to provide a more descriptive explanation, a different language translation, or to define a post-coordinated concept.

Annex B Normalized Information Object Definitions (Normative)

B.1 PATIENT INFORMATION OBJECT DEFINITION

B.1.1 IOD description

The Patient Information Object Definition is an abstraction of the information describing a patient upon whom medical imaging services are performed. The Patient IOD is tailored by Service Class Definitions that use services which facilitate the exchange of patient-related information between DICOM Application Entities.

A Patient SOP Instance uses the Patient IOD as a basis to describe a real world patient. Each Patient SOP Instance references related Visit SOP Instances and Study SOP Instances as described by the Entity-Relationship diagram in Section 7.

B.1.2 Patient IOD modules

Table B.1-1 identifies and defines the Modules that comprise this IOD. Modules listed are either mandatory or optional as specified in PS 3.4. Mandatory Modules contain Attributes that are included in all SOP Instances employing this IOD.

**Table B.1-1
PATIENT IOD MODULES**

Module	Reference	Module Description
SOP Common	C.12.1	Contains SOP common information
Patient Relationship	C.2.1	References to related SOPs
Patient Identification	C.2.2	Identifies the real world patient
Patient Demographic	C.2.3	Describe the patient
Patient Medical	C.2.4	Medical information about patient

B.2 VISIT INFORMATION OBJECT DEFINITION

B.2.1 IOD description

The Visit Information Object Definition is an abstraction of the information that describes a patient attendance to a healthcare provider. Because it is defined generically, this IOD may be used in applications ranging from inpatient hospital to outpatient radiological attendances. It includes such information as the admitting date and time, the admitting diagnosis, and the physician who referred the patient. The Visit IOD is tailored by Service Class Definitions that use services which facilitate the exchange of visit-related information between DICOM Application Entities.

A Visit SOP Instance uses the Visit Information Object Definition as a basis to describe a real world patient visit. Each Visit SOP Instance references related Patient SOP Instances and Study SOP Instances as described by the Entity-Relationship diagram in Section 7.

B.2.2 IOD modules

Table B.2-1 identifies and defines the Modules that comprise this IOD. Modules listed are either mandatory or optional as specified in PS 3.4. Mandatory Modules contain Attributes that are included in all SOP Instances employing this IOD.

**Table B.2-1
VISIT IOD MODULES**

Module	Reference	Module Description
SOP Common	C.12.1	Contains SOP common information
Visit Relationship	C.3.1	Reference to related SOPs
Visit Identification	C.3.2	Identifies the real world visit
Visit Admission	C.3.4	Describes patient's admission
Visit Status	C.3.3	Describes patient's stay
Visit Discharge	C.3.5	Describes patient's discharge
Visit Scheduling	C.3.6	Describes scheduling information for the patient's stay

B.3 STUDY INFORMATION OBJECT DEFINITION

B.3.1 IOD description

The Study Information Object Definition is an abstraction of the information which describes a diagnostic imaging study. It includes such information as the reason for performing the study, the radiological procedure performed, and the time and date of the radiological procedure. The Study IOD is tailored by Service Class Definitions which use services which facilitate the exchange of Study-related information between DICOM Application Entities.

A Study SOP Instance uses the Study Information Object Definition as a basis to describe a real world diagnostic imaging study for a patient. Each Study SOP Instance references related Visit SOP Instances and Patient SOP Instances as described by the Entity-Relationship diagram in Section 7.

B.3.2 IOD modules

Table B.3-1 identifies and defines the Modules which comprise this IOD. Modules listed are either mandatory or optional as specified in PS 3.4. Mandatory Modules contain Attributes which are included in all SOP Instances employing this IOD.

**Table B.3-1
STUDY IOD MODULES**

Module	Reference	Module Description
SOP Common	C.12.1	Contains SOP Common information
Study Relationship	C.4.1	References to related SOP's
Study Identification	C.4.2	Identifies the real world study
Study Classification	C.4.3	Classifies the real world study
Study Scheduling	C.4.4	Times and dates to perform study
Study Acquisition	C.4.5	Information acquired in study
Study Read	C.4.6	Reading related information

B.4 STUDY COMPONENT INFORMATION OBJECT DEFINITION

B.4.1 IOD description

A Study Component Information Object Definition is the specification of an abstract information model of summary information for a Study, which may be exchanged between connecting devices which claim conformance to the DICOM Standard. This Study Component is intended to be modality independent.

Each Study IOD as defined in Section B.3 relates to one or more Study Component IOD. This relationship is maintained by the Study Component Relationship Module. A Study Component represents one modality's contribution to a Study which may include additional components contributed by other modalities.

B.4.2 IOD modules

**Table B.4-1
STUDY COMPONENT IOD MODULES**

Module	Reference	Module Description
SOP Common	C.12.1	Contains SOP common information
Study Component Relationship	C.4.8	References to related SOPs
Study Component Acquisition	C.4.9	Status and acquisition information
Study Component	C.4.7	Identifies the related series

B.5 RESULTS INFORMATION OBJECT DEFINITION

B.5.1 IOD description

The Results Information Object Definition is an abstraction of the information resulting from the analysis of a diagnostic imaging study. This information consists of an initial report, some number of amendments to the initial report, and associated general Attributes. The Results IOD is tailored

by Service Class Definitions which use services which facilitate the exchange of results-related information between DICOM Application Entities.

A Results SOP Instance uses the Results Information Object Definition as a basis to describe real world diagnostic imaging results for a patient. Each Results SOP Instance references related Interpretation SOP Instances which represent diagnoses made during interpretation of the related studies. There may be one report (i.e. original interpretation) and many amendments (i.e. additional interpretations). The full results for a diagnostic study are hence the sum of the original report and all of its associated amendments.

Each Results SOP Instance references related Study SOP Instances and Interpretation SOP Instances as described by the Entity-Relationship diagram in Section 7.

B.5.2 IOD modules

Table B.5-1 identifies and defines the Modules which comprise this IOD. Modules listed are either mandatory or optional as specified in PS 3.4. Mandatory Modules contain Attributes which are included in all SOP Instances employing this IOD.

Table B.5-1
RESULTS IOD MODULES

Module	Reference	Module Description
SOP Common	C.12.1	Contains SOP common information
Results Relationship	C.5.1	References to related SOPs
Results Identification	C.5.2	Identifies the real world results
Results Impressions	C.5.3	Classifies the real world results

B.6 INTERPRETATION INFORMATION OBJECT DEFINITION

B.6.1 IOD description

The Interpretation Information Object Definition is an abstraction of the information resulting from a single interpretation of a diagnostic imaging study. This interpretation may be either a report (initial interpretation) or an amendment to a report for a diagnostic imaging study. The Interpretation IOD is tailored by Service Class Definitions which use services which facilitate the exchange of interpretation-related information between DICOM Application Entities.

An Interpretation SOP Instance uses the Interpretation Information Object Definition as a basis to describe real world interpretation of a diagnostic imaging study. Each Interpretation SOP Instance references one Results SOP Instance which represent the total diagnosis made for the related study. There may be one report interpretation and many amendment interpretations. The full results for a diagnostic study are hence the sum of the original report and all of its associated amendments.

B.6.2 IOD modules

Table B.6-1 identifies and defines the Modules which comprise this IOD. Modules listed are either mandatory or optional as specified in PS 3.4. Mandatory Modules contain Attributes which are included in all SOP Instances of this IOD.

**Table B.6-1
INTERPRETATION IOD MODULES**

Module	Reference	Module Description
SOP Common	C.12.1	Contains SOP Common information
Interpretation Relationship	C.6.1	References to related SOPs
Interpretation Identification	C.6.2	Identifies the real world interpretation
Interpretation State	C.6.3	State of real world interpretation
Interpretation Recording	C.6.4	When, by whom the interpretation was recorded
Interpretation Transcription	C.6.5	When, by whom the interpretation was transcribed
Interpretation Approval	C.6.6	When, by whom the interpretation was approved

B.7 BASIC FILM SESSION INFORMATION OBJECT DEFINITION

B.7.1 IOD description

The Basic Film Session Information Object Definition describes the presentation parameters, which are common for all the films of a film session (e.g. number of films, film destination).

B.7.2 IOD modules

**Table B.7-1
FILM SESSION IOD MODULES**

Module	Reference	Module Description
SOP Common	C.12.1	Contains SOP Common information
Basic Film Session Presentation	C.13.1	Contains Film Session presentations information
Basic Film Session Relationship	C.13.2	References to related SOPs

B.8 BASIC FILM BOX INFORMATION OBJECT DEFINITION

B.8.1 IOD description

The Basic Film Box Information Object Definition is an abstraction of the presentation of one film of the film session. The Basic Film Box IOD describes the presentation parameters which are common for all images on a given sheet of film.

B.8.2 IOD modules

Table B.8-1
BASIC FILM BOX IOD MODULES

Module	Reference	Module Description
SOP Common	C.12.1	Contains SOP Common information
Basic Film Box Presentation Module	C.13.3	Contains Film Box presentation information
Basic Film Box Relationship	C.13.4	References to related SOPs

B.9 BASIC IMAGE BOX INFORMATION OBJECT DEFINITION

B.9.1 IOD description

The Basic Image Box Information Object Definition is an abstraction of the presentation of an image and image related data in the image area of a film. The Basic Image Box IOD describes the presentation parameters and image pixel data which apply to a single image of a sheet of film.

B.9.2 IOD modules

Table B.9-1
BASIC IMAGE BOX IOD MODULES

Module	Reference	Module Description
SOP Common	C.12.1	Contains SOP Common information
Image Box Presentation Module	C.13.5	Contains Image Box presentation information

The Image Box Relationship Module was previously defined in DICOM. It is now retired. See PS 3.3-1998.

B.10 BASIC ANNOTATION INFORMATION OBJECT DEFINITION

B.10.1 IOD description

The Basic Annotation Box Information Object Definition is an abstraction of the presentation of an annotation (e.g. text string) on a film. The Basic Annotation Box IOD describes the most used text related presentation parameters.

B.10.2 IOD modules

**Table B.10-1
BASIC ANNOTATION IOD MODULES**

Module	Reference	Module Description
SOP Common	C.12.1	Contains SOP Common information
Basic Annotation Presentation Module	C.13.7	Contains annotation presentation information

B.11 PRINT JOB INFORMATION OBJECT DEFINITION

B.11.1 IOD description

The Print Job Information Object Definition is an abstraction of the print job transaction and is the basic information entity to monitor the execution of the print process. A print job contains one film or multiple films, all belonging to the same film session.

B.11.2 IOD modules

**Table B.11-1
PRINT JOB IOD MODULES**

Module	Reference	Module Description
SOP Common	C.12.1	Contains SOP Common information
Print Job Module	C.13.8	Contains print job transaction information

B.12 PRINTER INFORMATION OBJECT DEFINITION

B.12.1 IOD description

The Printer Information Object Definition is an abstraction of the hardcopy printer and is the basic information entity to monitor the status of the printer.

B.12.2 IOD modules

**Table B.12-1
PRINTER IOD MODULES**

Module	Reference	Module Description
SOP Common	C.12.1	Contains SOP Common information
Printer Module	C.13.9	Contains status information to monitor the printer

B.13 VOI LUT BOX INFORMATION OBJECT DEFINITION (RETIRED)

This section was previously defined in DICOM. It is now retired. See PS 3.3-1998.

B.14 IMAGE OVERLAY BOX INFORMATION OBJECT DEFINITION (RETIRED)

This section was previously defined in DICOM. It is now retired. See PS 3.3-1998.

B.15 STORAGE COMMITMENT INFORMATION OBJECT DEFINITION

B.15.1 Storage Commitment IOD Description

The Storage Commitment IOD describes the Attributes which may be present in a Storage Commitment Request or Response. The SOP Instances referenced by the Storage Commitment IOD are not restricted to images and may include other SOP Instances.

B.15.2 Storage Commitment IOD Modules

Table B.15-1 identifies and defines the Modules which comprise this IOD. The requirements for whether Attributes in these Modules are mandatory or optional are as specified in PS 3.4.

**Table B.15-1
STORAGE COMMITMENT IOD MODULES**

Module	Reference	Module Description
SOP Common	C.12.1	Contains SOP common information
Storage Commitment	C.14	Contains references to the SOP Instances and associated information which are contained in Storage Commitment.

B.16 PRINT QUEUE INFORMATION OBJECT DEFINITION

B.16.1 IOD Description

The Print Queue IOD is an abstraction of a print queue. The Print Queue IOD is related to the Printer IOD, which corresponds to one printer or a group of printers (see also PS 3.4).

The Print Queue IOD describes the content and status of the queue. The Print Queue IOD contains a list of queue entries. A queue entry is an abstraction of the print job transaction and is the basic information entity to monitor the execution of the print process. A print job contains one film or multiple films, all belonging to the same film session.

With the Print Queue IOD, an SCU can monitor all jobs in the queue. In addition, the SCU can manage jobs for which it knows the Owner ID.

B.16.2 IOD Modules

**Table B.16-1
PRINT QUEUE IOD MODULES**

Module	Reference
SOP Common Information	C.12.1
General Queue Module	C.15.1
Print Queue Module	C.15.2

B.17 MODALITY PERFORMED PROCEDURE STEP INFORMATION OBJECT DEFINITION

B.17.1 IOD Description

A "Modality Performed Procedure Step Information Object Definition" is an abstraction of the information that describes the activities, conditions and results of an imaging procedure performed on a modality. It contains information about the Modality Performed Procedure Step (MPPS) and its relations to other Information Entities of the DICOM real-world model as introduced in this Part.

A Modality Performed Procedure Step is related to the actual imaging procedure carried out at the modality. Other types of Performed Procedure Steps, e.g. reporting or image processing, are not covered by the Modality Performed Procedure Step IOD. The information gathered includes data about the performance of the procedure itself, radiation dose values to which the patient has been exposed, and data for billing and material management. The Modality Performed Procedure Step IOD includes general PPS modules and image acquisition specific ones, such as Image Acquisition Results, Radiation Dose and Billing and Material Management.

B.17.2 IOD Modules

Table B.17.2-1 lists the modules which make up the Modality Performed Procedure Step IOD.

Table B.17.2-1
MODALITY PERFORMED PROCEDURE STEP IOD MODULES

Module	Reference	Module Description
SOP Common	C.12.1	Contains SOP common information
Performed Procedure Step Relationship	C.4.13	References the related SOPs and IEs.
Performed Procedure Step Information	C.4.14	Includes identifying and status information as well as place and time
Image Acquisition Results	C.4.15	Identifies Series, Images, Standalone LUTs, Overlays and Curves related to this PPS and specific image acquisition conditions.
Radiation Dose	C.4.16	Contains radiation dose information related to this Performed Procedure Step.
Billing and Material Management Codes	C.4.17	Contains codes for billing and material management.

Notes: The Radiation Dose Module (C.4.16) does not have meaning if the modality does not generate ionizing radiation or if the generator does not provide the area dose product.

B.18 PRESENTATION LUT INFORMATION OBJECT DEFINITION

B.18.1 IOD Description

The Presentation LUT Information Object is an abstraction of a Presentation LUT. The objective of the Presentation LUT is to realize image display tailored for specific modalities, applications, and user preferences. It is used to prepare image pixel data for display on devices that conform to the Grayscale Standard Display Function defined in PS 3.14.

The output of the Presentation LUT is Presentation Values (P-Values). P-Values are approximately related to human perceptual response. They are intended to facilitate common input for both hardcopy and softcopy display devices. P-Values are intended to be independent of the specific class or characteristics of the display device.

B.18.2 IOD Modules

Module	Reference
SOP Common Information	C.12.1
Presentation LUT Module	C.11.4

B.19 PULL PRINT REQUEST INFORMATION OBJECT DEFINITION

B.19.1 IOD description

The Pull Print Request IOD is an abstraction of a request to print one or more films, based on the information stored in the Stored Print IOD.

The Pull Print Request IOD contains print transaction related information (e.g. priority, number of copies) and a reference to the Stored Print IOD, which contains the print presentation parameters and references to images.

Note: The Film Session IOD is split into 2 IODs :

- Stored Print IOD, containing layout information and references to images. It contains information which remains invariant during subsequent re-prints (of the same film session). The Stored Print IOD may be archived.
- Print Request IOD, which contains information that may change during subsequent re-prints.

The E-R Model in Section A.1.2 depicts those components of the DICOM Information Model which are related to the Pull Print Request IOD.

B.19.2 IOD module table

Table B.19-1
PULL PRINT REQUEST IOD MODULES

Module	Reference	Usage
Print Request	C.13.12	M
SOP Common Information	C.12.1	M

B.20 PRINTER CONFIGURATION INFORMATION OBJECT DEFINITION

B.20.1 IOD Description

The Printer Configuration IOD describes key imaging characteristics of the printer.

B.20.2 IOD Modules

**Table B.20-1
Printer Configuration IOD Modules**

Module	Reference	Module Description
SOP Common	C.12.1	Contains SOP Common Information
Printer	C13.9	Contains information about the printer
Printer Configuration	C.13.13	Contains Printer Configuration Information

B.21 BASIC PRINT IMAGE OVERLAY BOX INFORMATION OBJECT DEFINITION

B.21.1 IOD Description

The Basic Print Image Overlay Box IOD is an abstraction of the presentation of an image overlay in a basic image box. It contains the overlay pixel data to be printed on the image. A single overlay plane is supported. Overlays may be printed on both color and grayscale images. However, printing of the overlay pixels is only supported in black or white.

B.21.2 IOD Modules

Module	Reference
SOP Common Information	C.12.1
Basic Print Image Overlay Box Module	C.9.5

B.22 GENERAL PURPOSE SCHEDULED PROCEDURE STEP INFORMATION OBJECT DEFINITION

B.22.1 IOD Description

A "General Purpose Scheduled Procedure Step Information Object Definition" is an abstraction of the information that describes the scheduled activities, conditions and status of a scheduled procedure step. It contains information about the General Purpose Scheduled Procedure Step (GP-SPS) and its relations to other Information Entities of the DICOM real-world model as introduced in PS 3.3.

A General Purpose Scheduled Procedure Step is related to one of the steps to be performed in response to the Requested Procedure.

B.22.2 IOD Modules

Table B.22.2-1 lists the modules which make up the General Purpose Scheduled Procedure Step IOD.

**Table B.22.2-1
GENERAL PURPOSE SCHEDULED PROCEDURE STEP IOD MODULES**

Module	Reference	Module Description
SOP Common	C.12.1	Contains SOP common information
General Purpose Scheduled Procedure Step Relationship	C.4.18	References the related SOPs and IEs.

General Purpose Scheduled Procedure Step Information	C.4.19	Includes identifying and status information as well as place and time
--	--------	---

B.23 GENERAL PURPOSE PERFORMED PROCEDURE STEP INFORMATION OBJECT DEFINITION

B.23.1 IOD Description

A "General Purpose Performed Procedure Step Information Object Definition" is an abstraction of the information that describes the activities, conditions and results of a procedure step performed on a performing device. It contains information about the General Purpose Performed Procedure Step (GP-PPS) and its relations to other Information Entities of the DICOM real-world model as introduced in PS 3.3.

A General Purpose Performed Procedure Step is related to the procedure scheduled to be performed. The information gathered at the performing device includes data about the performance of the procedure step itself and the results. The General Purpose Performed Procedure Step IOD includes general GP-PPS modules and a specific one for the created results, the General Purpose Results.

B.23.2 IOD Modules

Table B.21.2-1 lists the modules, which make up the General Purpose Performed Procedure Step IOD.

**Table B.23.2-1
GENERAL PURPOSE PERFORMED PROCEDURE STEP IOD MODULES**

Module	Reference	Module Description
SOP Common	C.12.1	Contains SOP common information
General Purpose Performed Procedure Step Relationship	C.4.20	References the related SOPs and IEs.
General Purpose Performed Procedure Step Information	C.4.21	Includes identifying and status information as well as place and time
General Purpose Results	C.4.22	Identifies Results related to this GP-PPS.

Annex C INFORMATION MODULE DEFINITIONS (NORMATIVE)

C.1 ELEMENTS OF A MODULE DEFINITION

A Module Definition is composed of the following Sections

- a. Module Description
- b. Module Definition
- c. Attribute Description (Optional)

Sections C.1.1 through C.1.3 define the requirements of a. through c. above.

C.1.1 Module Description

This Section briefly describes the Module and references the Module Definition.

C.1.2 Module Definition

This Section contains a table which enumerates each Attribute contained in the Module. For each Attribute in the table the following information is given:

- a. Attribute Name (see C.1.2.1)
- b. Data Element Tag (see C.1.2.2)
- c. Type Designation (see C.1.2.3)
- d. Attribute Definition (see C.1.2.4)

C.1.2.1 Attribute Name

This name shall be used whenever referencing the Attribute. This name shall also identify the Attribute in PS 3.6.

C.1.2.2 Attribute Tag

Each Attribute has a tag which uniquely identifies the Attribute (also used for encoding into a Data Set - see PS 3.5). This tag also serves as an index into the Data Dictionary of PS 3.6.

C.1.2.3 Type Designation

Each Attribute contained in a Module referenced by a Composite IOD defines a Type designation which indicates if a specific Attribute is required for all DIMSE operations/notifications associated with a SOP Class using this Module. PS 3.5 defines a choice of generic Type designations available for DICOM Attributes.

Note: The Type designation specified is generally determined by the value most appropriate for the C-STORE DIMSE Service.

The Type designation given in a Module is a default value and as such may be overridden by an IOD referencing the Module. Some Attributes may also be contained in more than one Module for the IOD. In that case, the Type designation applicable for the Attribute of the specific IOD is the lowest Type value (e.g. if type 2 is specified in one Module and type 3 in another, then type 2 shall apply), unless explicitly stated by the Attribute description.

The Type designation given in a Module (and/or IOD) may also be overridden by Service Class Definitions referencing the IOD containing the Module. PS 3.4 specifies the Service Class Definitions.

C.1.2.4 Attribute Definition

A brief definition will be provided for each attribute in the Module definition table. The description shall provide a context for the use of the Attribute and provide general elucidation. Defined Terms and Enumerated Values applicable to the Attribute may also be listed in the Attribute Description.

C.1.3 Attribute Descriptions

Additional information may be provided if necessary for selected Attributes. Such information shall be placed following the Module definition table. Dependencies between Attributes may be specified in this Section.

C.2 PATIENT MODULES

The following Sections specify Modules used for patient management.

C.2.1 Patient Relationship Module

Table C.2-1 defines the Attributes that reference SOP Instances related to this SOP Class.

**Table C.2-1
PATIENT RELATIONSHIP MODULE ATTRIBUTES**

Attribute Name	Tag	Attribute Description
Referenced Study Sequence	(0008,1110)	Uniquely identifies the Study SOP Instances associated with the Patient SOP Instance. One or more Items may be included in this Sequence.
>Referenced SOP Class UID	(0008,1150)	Uniquely identifies the referenced SOP Class.
>Referenced SOP Instance UID	(0008,1155)	Uniquely identifies the referenced SOP Instance.
Referenced Visit Sequence	(0008,1125)	Uniquely identifies the Visit SOP Instances associated with this Patient SOP Instance. One or more Items may be included in this Sequence.
>Referenced SOP Class UID	(0008,1150)	Uniquely identifies the referenced SOP Class.
>Referenced SOP Instance UID	(0008,1155)	Uniquely identifies the referenced SOP Instance.
Referenced Patient Alias Sequence	(0038,0004)	Uniquely identifies any Patient SOP Instances which also describe this patient. These SOP Instances are aliases. Zero or more Items may be included in this Sequence.
>Referenced SOP Class UID	(0008,1150)	Uniquely identifies the referenced SOP Class.
>Referenced SOP Instance UID	(0008,1155)	Uniquely identifies the referenced SOP Instance.

C.2.2 Patient Identification Module

Table C.2-2 defines the Attributes relevant to identifying a patient.

**Table C.2-2
PATIENT IDENTIFICATION MODULE ATTRIBUTES**

Attribute Name	Tag	Attribute Description
Patient's Name	(0010,0010)	Patient's full name
Patient ID	(0010,0020)	Primary hospital identification number or code for the patient
Issuer of Patient ID	(0010,0021)	Name of healthcare provider which issued the Patient ID
Other Patient IDs	(0010,1000)	Other identification numbers or codes used to identify the patient
Other Patient Names	(0010,1001)	Other names used to identify the patient
Patient's Birth Name	(0010,1005)	Patient's birth name
Patient's Mother's Birth Name	(0010,1060)	Birth name of patient's mother
Medical Record Locator	(0010,1090)	An identifier used to find the patient's existing medical record (e.g. film jacket)

C.2.3 Patient Demographic Module

Table C.2-3 defines the Attributes relevant to generally describing a patient.

**Table C.2-3
PATIENT DEMOGRAPHIC MODULE ATTRIBUTES**

Attribute Name	Tag	Attribute Description
Patient's Age	(0010,1010)	Age of the Patient.
Occupation	(0010,2180)	Occupation of the Patient.
Patient Data Confidentiality Constraint Description	(0040,3001)	Special indication to the modality operator about confidentiality of patient information (e.g., that he should not use the patients name where other patients are present).
Patient's Birth Date	(0010,0030)	Date of birth of the named patient
Patient's Birth Time	(0010,0032)	Time of birth of the named patient
Patient's Sex	(0010,0040)	Sex of the named patient. Enumerated Values: M = male F = female O = other
Patient's Insurance Plan Code Sequence	(0010,0050)	A sequence that conveys the patient's insurance plan. Zero or more Items may be included in this Sequence.
<i>>Include 'Code Sequence Macro' Table 8.8-1</i>		<i>No Baseline Context ID is defined.</i>
Patient's Primary Language Code Sequence	(0010,0101)	The languages which can be used to communicate with the patient. Zero or more Items may be included in the sequence. The sequence items are ordered by preference (most preferred language to least preferred language).
<i>> Include Code Sequence Macro Table 8.8-2</i>		<i>Baseline Context ID is CID 5000 - Languages.</i>
> Patient's Primary Language Code Modifier Sequence	(0010,0102)	A modifier for a Patient's Primary Language. Can be used to specify a national language variant. Exactly one Item may be included in the sequence.
<i>>> Include Code Sequence Macro Table 8.8-2</i>		<i>Baseline Context ID is CID 5001 - Countries.</i>
Patient's Size	(0010,1020)	Patient's height or length in meters
Patient's Weight	(0010,1030)	Weight of the patient in kilograms
Patient's Address	(0010,1040)	Legal address of the named patient
Military Rank	(0010,1080)	Military rank of patient
Branch of Service	(0010,1081)	Branch of the military. The country allegiance may also be included (e.g. U.S. Army).
Country of Residence	(0010,2150)	Country in which patient currently resides
Region of Residence	(0010,2152)	Region within patient's country of residence
Patient's Telephone Numbers	(0010,2154)	Telephone numbers at which the patient can be reached
Ethnic Group	(0010,2160)	Ethnic group or race of patient

Patient's Religious Preference	(0010,21F0)	The religious preference of the patient
Patient Comments	(0010,4000)	User-defined comments about the patient

C.2.4 Patient Medical Module

Table C.2-4 defines the Attributes relevant to a patient's medical state or history.

Table C.2-4
PATIENT MEDICAL MODULE ATTRIBUTES

Attribute Name	Tag	Attribute Description
Medical Alerts	(0010,2000)	Conditions to which medical staff should be alerted (e.g. contagious condition, drug allergies, etc.)
Contrast Allergies	(0010,2110)	Description of prior reaction to contrast agents.
Smoking Status	(0010,21A0)	Indicates whether patient smokes. Enumerated Values: YES NO UNKNOWN
Additional Patient History	(0010,21B0)	Additional information about the patient's medical history
Pregnancy Status	(0010,21C0)	Describes pregnancy state of patient. Enumerated Values: 0001 = not pregnant 0002 = possibly pregnant 0003 = definitely pregnant 0004 = unknown
Last Menstrual Date	(0010,21D0)	Date of onset of last menstrual period
Special Needs	(0038,0050)	Medical and social needs (e.g. wheelchair, oxygen, non-English-speaking etc.)
Patient State	(0038,0500)	Description of patient state (comatose, disoriented, vision impaired etc.)

C.3 VISIT MODULES

The following Sections specify Modules relevant to a real world patient visit.

C.3.1 Visit Relationship Module

Table C.3-1 defines the Attributes which reference SOP Instances related to this SOP Class.

**Table C.3-1
VISIT RELATIONSHIP MODULE ATTRIBUTES**

Attribute Name	Tag	Attribute Description
Referenced Study Sequence	(0008,1110)	Uniquely identifies the Study SOP Instances associated with the Visit SOP Instance. One or more Items may be included in this Sequence.
>Referenced SOP Class UID	(0008,1150)	Uniquely identifies the referenced SOP Class.
>Referenced SOP Instance UID	(0008,1155)	Uniquely identifies the referenced SOP Instance.
Referenced Patient Sequence	(0008,1120)	Uniquely identifies the Patient SOP Instance that relates to the Visit SOP Instance. Only a single Item shall be permitted in this Sequence.
>Referenced SOP Class UID	(0008,1150)	Uniquely identifies the referenced SOP Class.
>Referenced SOP Instance UID	(0008,1155)	Uniquely identifies the referenced SOP Instance.

C.3.2 Visit Identification Module

Table C.3-2 defines the Attributes relevant to identifying a visit.

**Table C.3-2
VISIT IDENTIFICATION MODULE ATTRIBUTES**

Attribute Name	Tag	Attribute Description
Institution Name	(0008,0080)	Institution where the equipment is located
Institution Address	(0008,0081)	Mailing Address of the institution where the equipment is located
Institution Code Sequence	(0008,0082)	A sequence that conveys the healthcare facility identification. Only a single Item shall be permitted in this Sequence.
>Include 'Code Sequence Macro' Table 8.8-1		No Baseline Context ID is defined.
Admission ID	(0038,0010)	Identification number of the visit as assigned by the healthcare provider
Issuer of Admission ID	(0038,0011)	Name of healthcare provider which issued the Admission ID

C.3.3 Visit Status Module

Table C.3-3 defines the Attributes relevant to the patient's stay with the healthcare provider.

Table C.3-3
VISIT STATUS MODULE ATTRIBUTES

Attribute Name	Tag	Attribute Description
Visit Status ID	(0038,0008)	Identifies the state of the visit. Defined Terms: CREATED = Created but not yet scheduled SCHEDULED = Scheduled but not yet admitted ADMITTED = Patient admitted to institution DISCHARGED = Patient Discharged
Current Patient Location	(0038,0300)	Describes the current known location of the patient
Patient's Institution Residence	(0038,0400)	Primary location where patient resides (ward, floor, room, etc. or outpatient)
Visit Comments	(0038,4000)	User-defined comments about the visit

C.3.4 Visit Admission Module

Table C.3-4 defines the Attributes relevant to admitting a patient during a visit.

Table C.3-4
VISIT ADMISSION MODULE ATTRIBUTES

Attribute Name	Tag	Attribute Description
Referring Physician's Name	(0008,0090)	Patient's primary referring physician for this visit
Referring Physician's Address	(0008,0092)	Referring physician's address
Referring Physician's Phone Numbers	(0008,0094)	Referring physician's phone numbers
Admitting Diagnoses Description	(0008,1080)	Description of admitting diagnosis (diagnoses).
Admitting Diagnoses Code Sequence	(0008,1084)	A sequence that conveys the admitting diagnosis (diagnoses). One or more Items may be included in this Sequence.
<i>>Include 'Code Sequence Macro' Table 8.8-1</i>		<i>No Baseline Context ID is defined.</i>
Route of Admissions	(0038,0016)	Mode of admission: emergency, normal
Admitting Date	(0038,0020)	Date patient visit began
Admitting Time	(0038,0021)	Time patient visit began

C.3.5 Visit Discharge Module

Table C.3-5 defines the Attributes relevant to the discharging of a patient from a visit.

**Table C.3-5
VISIT DISCHARGE MODULE ATTRIBUTES**

Attribute Name	Tag	Attribute Description
Discharge Date	(0038,0030)	Date patient visit ended or is scheduled to end.
Discharge Time	(0038,0032)	Time patient visit ended or is scheduled to end.
Discharge Diagnosis Description	(0038,0040)	Institution-generated description of discharge diagnosis.
Discharge Diagnosis Code Sequence	(0038,0044)	A sequence that conveys the discharge diagnosis. One or more Items may be included in this Sequence.
<i>>Include 'Code Sequence Macro' Table 8.8-1</i>		<i>No Baseline Context ID is defined.</i>

C.3.6 Visit Scheduling Module

Table C.3-6 defines the Attributes relevant to the scheduling of a patient visit.

**Table C.3-6
VISIT SCHEDULING MODULE ATTRIBUTES**

Attribute Name	Tag	Attribute Description
Scheduled Admission Date	(0038,001A)	Date patient visit is scheduled to start
Scheduled Admission Time	(0038,001B)	Time patient visit is scheduled to start
Scheduled Discharge Date	(0038,001C)	Date patient visit is scheduled to end
Scheduled Discharge Time	(0038,001D)	Time patient visit is scheduled to end
Scheduled Patient Institution Residence	(0038,001E)	Scheduled location where patient is to reside (ward, floor, room, etc. or outpatient)

C.4 STUDY MODULES

The following Sections specify Modules relevant to a real world diagnostic imaging study performed on a patient.

C.4.1 Study Relationship Module

Table C.4-1 defines the Attributes which reference SOP Instances Subordinate or Superior to this SOP Class in the Naming Hierarchy.

**Table C.4-1
STUDY RELATIONSHIP MODULE ATTRIBUTES**

Attribute Name	Tag	Attribute Description
Referenced Visit Sequence	(0008,1125)	Uniquely identifies the Visit SOP Instances associated with this Study SOP Instance. One or more Items may be included in this Sequence.
>Referenced SOP Class UID	(0008,1150)	Uniquely identifies the referenced SOP Class.
>Referenced SOP Instance UID	(0008,1155)	Uniquely identifies the referenced SOP Instance.
Referenced Patient Sequence	(0008,1120)	Uniquely identifies the Patient SOP Instance that relates to the Study SOP Instance. Only a single Item shall be permitted in this Sequence.
>Referenced SOP Class UID	(0008,1150)	Uniquely identifies the referenced SOP Class.
>Referenced SOP Instance UID	(0008,1155)	Uniquely identifies the referenced SOP Instance.
Referenced Results Sequence	(0008,1100)	Uniquely identifies the results SOP Instance for which the interpretation SOP Instance applies. Zero or more Items may be included in this Sequence.
>Referenced SOP Class UID	(0008,1150)	Uniquely identifies the referenced SOP Class.
>Referenced SOP Instance UID	(0008,1155)	Uniquely identifies the referenced SOP Instance.
Referenced Study Component Sequence	(0008,1111)	Uniquely identifies the Study Component SOP Instances to which the Study SOP Instance is related.
>Referenced SOP Class UID	(0008,1150)	Uniquely identifies the referenced SOP Class.
>Referenced SOP Instance UID	(0008,1155)	Uniquely identifies the referenced SOP Instance.
Study Instance UID	(0020,000D)	Unique identifier for the Study
Accession Number	(0008,0050)	A RIS generated number which identifies the order for the Study.

C.4.2 Study Identification Module

Table C.4-2 defines the Attributes relevant to identifying a study.

**Table C.4-2
STUDY IDENTIFICATION MODULE ATTRIBUTES**

Attribute Name	Tag	Attribute Description
Study ID	(0020,0010)	User or equipment generated Study identifier
Study ID Issuer	(0032,0012)	Name of healthcare provider that issued the Study ID
Other Study Numbers	(0020,1070)	Other identifiers assigned to study by institution

C.4.3 Study Classification Module

Table C.4-3 defines the Attributes relevant to classifying a study.

Table C.4-3
STUDY CLASSIFICATION MODULE ATTRIBUTES

Attribute Name	Tag	Attribute Description
Study Status ID	(0032,000A)	Identifies the state of the study. Enumerated Values: CREATED = Created but not yet scheduled SCHEDULED = Scheduled but not yet started ARRIVED = Patient Arrived but study not started STARTED = Started but not yet finished COMPLETED = Complete but image quality not verified VERIFIED = Complete and image quality verified READ = Read by the Physicians
Study Priority ID	(0032,000C)	Identifies the priority of the study. Enumerated values: LOW, MED, HIGH
Study Comments	(0032,4000)	User-defined comments about the study

C.4.4 Study Scheduling Module

Table C.4-4 defines the Attributes relevant to scheduling a study.

**Table C.4-4
STUDY SCHEDULING MODULE ATTRIBUTES**

Attribute Name	Tag	Attribute Description
Scheduled Study Start Date	(0032,1000)	Date on which the study is scheduled to start
Scheduled Study Start Time	(0032,1001)	Time at which the study is scheduled to start
Scheduled Study Stop Date	(0032,1010)	Date on which the patient examination for the study is scheduled to end
Scheduled Study Stop Time	(0032,1011)	Time at which the patient examination for the study is scheduled to end
Scheduled Study Location	(0032,1020)	User-defined location at which the study will be performed
Scheduled Study Location AE Title	(0032,1021)	A list of Application Entity Title(s) of the location at which the study will be performed
Reason for Study	(0032,1030)	Describes the reason for performing study
Requesting Physician	(0032,1032)	Physician who requested the study
Requesting Service	(0032,1033)	Institutional department where the request initiated.
Requested Procedure Description	(0032,1060)	Institution-generated description or classification of requested procedure
Requested Procedure Code Sequence	(0032,1064)	A sequence that conveys the requested procedure. One or more Items may be included in this Sequence.
<i>>Include 'Code Sequence Macro' Table 8.8-1</i>		<i>No Baseline Context ID is defined.</i>
Requested Contrast Agent	(0032,1070)	Contrast agent requested for use in the procedure

C.4.5 Study Acquisition Module

Table C.4-5 defines the Attributes relevant to acquiring a study.

**Table C.4-5
STUDY ACQUISITION MODULE ATTRIBUTES**

Attribute Name	Tag	Attribute Description
Study Arrival Date	(0032,1040)	Date that patient arrived at study check-in location
Study Arrival Time	(0032,1041)	Time at which patient arrived at study check-in location
Study Date	(0008,0020)	Date on which the acquisition of the study information was started
Study Time	(0008,0030)	Time at which the acquisition of the study information was started
Study Completion Date	(0032,1050)	Date on which the acquisition of study information was completed
Study Completion Time	(0032,1051)	Time at which the acquisition of study information was completed
Study Verified Date	(0032,0032)	Date on which the image quality for the patient examination was verified
Study Verified Time	(0032,0033)	Time at which the image quality for the patient examination was verified
Modalities in Study	(0008,0061)	This Attribute may take one or more of the values defined for Modality (0008,0060)
Series in Study	(0020,1000)	Number of series in the study
Acquisitions in Study	(0020,1004)	Number of image data acquisitions used in performing the study

C.4.6 Study Read Module

Table C.4-6 defines the Attributes relevant to the reading of a study.

**Table C.4-6
STUDY READ MODULE ATTRIBUTES**

Attribute Name	Tag	Attribute Description
Name of Physician (s) Reading Study	(0008,1060)	Physician(s) reading the study
Study Read Date	(0032,0034)	Date on which the study was read
Study Read Time	(0032,0035)	Time at which the study was read

C.4.7 Study Component Module

Table C.4-7 defines the Attributes relevant to the study component.

Table C.4-7
STUDY COMPONENT MODULE ATTRIBUTES

Attribute Name	Tag	Attribute Description
Study ID	(0020,0010)	User or equipment generated Study identifier
Study Instance UID	(0020,000D)	Unique identifier for the Study
Referenced Series Sequence	(0008,1115)	Sequence of Repeating Items where each Item includes the Attributes of a Series. Zero or more Items may be included in this Sequence.
>Series Date	(0008,0021)	Date the Series started.
>Series Time	(0008,0031)	Time the Series started.
>Series Instance UID	(0020,000E)	Unique identifier of the Series.
>Retrieve AE Title	(0008,0054)	Title of the DICOM Application Entity where the Image(s) may be retrieved on the network.
>Storage Media File-Set ID	(0088,0130)	The user or implementation specific human readable identifier that identifies the Storage Media on which the Image(s) reside.
>Storage Media File-Set UID	(0088,0140)	Uniquely identifies the Storage Media on which the Image(s) reside.
>Referenced Image Sequence	(0008,1140)	Sequence of Repeating Items where each Item provides reference to a set of Image SOP Class/SOP Instance pairs that are contained in the Series identified by the Series Instance UID (0020,000E). One or more Items may be included in this Sequence.
>>Referenced SOP Class UID	(0008,1150)	Uniquely identifies the referenced SOP Class. This Attribute is used only if Images may be retrieved as Single Image SOP Classes.
>>Referenced SOP Instance UID	(0008,1155)	Uniquely identifies the referenced SOP Instance. This Attribute is used only if Images may be retrieved as Single Image SOP Classes.
>>Retrieve AE Title	(0008,0054)	Title of the DICOM Application Entity where the Image(s) may be retrieved on the network.
>>Storage Media File-Set ID	(0088,0130)	The user or implementation specific human readable identifier that identifies the Storage Media on which the Image(s) reside.
>>Storage Media File-Set UID	(0088,0140)	Uniquely identifies the Storage Media on which the Image(s) reside.

C.4.8 Study Component Relationship Module

**Table C.4-8
STUDY COMPONENT RELATIONSHIP MODULE ATTRIBUTES**

Attribute Name	Tag	Attribute Description
Referenced Study Sequence	(0008,1110)	Uniquely identifies the Study SOP Instances associated with this SOP Instance.
>Referenced SOP Class UID	(0008,1150)	Uniquely identifies the SOP Class.
>Referenced SOP Instance UID	(0008,1155)	Uniquely identifies the SOP Instance.

C.4.9 Study Component Acquisition Module

**Table C.4-9
STUDY COMPONENT ACQUISITION MODULE ATTRIBUTES**

Attribute Name	Tag	Attribute Description
Modality	(0008,0060)	Type of equipment that acquired the data used to create the images in this Study Component. See C.7.3.1.1.1 for Defined Terms.
Study Description	(0008,1030)	Institution-generated description or classification of the Study (component) performed.
Procedure Code Sequence	(0008,1032)	A sequence that conveys the (single) type of procedure performed. Only a single Item shall be permitted in this Sequence.
<i>>Include 'Code Sequence Macro' Table 8.8-1</i>		<i>No Baseline Context ID is defined.</i>
Performing Physician's Name	(0008,1050)	Physician administering the study
Study Component Status ID	(0032,1055)	Identifies the state of the Study Component. Enumerated values: CREATED = Instance created but not yet complete INCOMPLETE = Acquisition not complete COMPLETED = Acquisition complete VERIFIED = Acquisition complete and Quality Control review complete POSTINTERPRET = Instance created or updated after referenced Study Instance status = COMPLETED

C.4.10 Scheduled Procedure Step Module

**Table C.4-10
SCHEDULED PROCEDURE STEP MODULE ATTRIBUTES**

Attribute Name	Tag	Attribute Description
Scheduled Procedure Step Sequence	(0040,0100)	One or more Scheduled Procedure Steps for one Requested Procedure.
>Scheduled Station AE Title	(0040,0001)	The AE title of the modality on which the Scheduled Procedure Step is scheduled to be performed.
>Scheduled Station Name	(0040,0010)	An institution defined name for the modality on which the Scheduled Procedure Step is scheduled to be performed.
>Scheduled Procedure Step Location	(0040,0011)	The location at which the Procedure Step is scheduled to be performed.
>Scheduled Procedure Step Start Date	(0040,0002)	Date on which the Scheduled Procedure Step is scheduled to start.
>Scheduled Procedure Step Start Time	(0040,0003)	Time at which the Scheduled Procedure Step is scheduled to start.
>Scheduled Procedure Step End Date	(0040,0004)	Date on which the Scheduled Procedure Step is scheduled to end.
>Scheduled Procedure Step End Time	(0040,0005)	Time at which the Scheduled Procedure Step is scheduled to end.
>Scheduled Performing Physician's Name	(0040,0006)	Name of the physician scheduled to administer the Scheduled Procedure Step.
>Scheduled Procedure Step Description	(0040,0007)	Institution-generated description or classification of the Scheduled Procedure Step to be performed. Note: The purpose of this attribute is to store a description or classification that is used at a local level (e.g., a hospital or a managed care network), and this description need not comply to an accepted standard.
>Scheduled Protocol Code Sequence	(0040,0008)	Sequence describing the Scheduled Protocol following a specified coding scheme. This sequence contains one or more Items.
>>Include 'Code Sequence Macro' Table 8.8-1		No Baseline Context ID is defined.
>Scheduled Procedure Step ID	(0040,0009)	Identifier which identifies the Scheduled Procedure Step.
>Scheduled Procedure Step Status	(0040,0020)	Defines the state of the Scheduled Procedure Step. Defined Terms: SCHEDULED ARRIVED
>Comments on the Scheduled Procedure Step	(0040,0400)	User-defined comments on the Scheduled Procedure Step. Note: The Comments attribute is intended to transmit non-structured information, which can be displayed to the operator of the Modality.

>Modality	(0008,0060)	Source equipment for the image. See Section C.7.3.1.1.1 for Enumerated Values.
>Requested Contrast Agent	(0032,1070)	Contrast agent requested for use in the Scheduled Procedure Step.
>Pre-Medication	(0040,0012)	Medication to be administered at the beginning of the Scheduled Procedure Step, e.g. Nuclear Medicine radiopharmaceutical.

C.4.11 Requested Procedure Module

**Table C.4-11
REQUESTED PROCEDURE MODULE ATTRIBUTES**

Attribute Name	Tag	Attribute Description
Requested Procedure ID	(0040,1001)	Identifier which identifies the Requested Procedure in the Imaging Service Request.
Reason for the Requested Procedure	(0040,1002)	Reason for requesting this imaging procedure. Note: This reason is more specific to the requested procedure than the reason mentioned in the imaging service request (0040,2001).
Requested Procedure Comments	(0040,1400)	User-defined comments on the Requested Procedure. Note: The Comments attribute is intended to transmit non-structured information, which can be displayed to the operator of the equipment (e.g. Modality).
Requested Procedure Code Sequence	(0032,1064)	A sequence that conveys the Requested Procedure of one Procedure Type.
<i>>Include 'Code Sequence Macro' Table 8.8-1</i>		<i>No Baseline Context ID is defined.</i>
Study Instance UID	(0020,000D)	Unique identifier to be used to identify the Study
Referenced Study Sequence	(0008,1110)	Uniquely identifies the Study SOP Instances associated with this SOP Instance.
>Referenced SOP Class UID	(0008,1150)	Uniquely identifies the SOP Class.
>Referenced SOP Instance UID	(0008,1155)	Uniquely identifies the SOP Instance.
Requested Procedure Description	(0032,1060)	Institution-generated administrative description or classification of Requested Procedure
Requested Procedure Priority	(0040,1003)	Requested Procedure Type Urgency. Defined Terms: STAT, HIGH, ROUTINE, MEDIUM, LOW
Patient Transport Arrangements	(0040,1004)	Mode of transportation of the patient to the location of examination.
Requested Procedure Location	(0040,1005)	Physical location at which the Requested Procedure is to be performed.
Confidentiality Code	(0040,1008)	Confidentiality Constraints on the Requested Procedure by the party filling the order.

Reporting Priority	(0040,1009)	Requested Reporting Priority. Defined Terms: HIGH, ROUTINE, MEDIUM, LOW
Names of Intended Recipients of Results	(0040,1010)	Names of the physicians, who are intended recipients of results.

Note: Attributes (0040,1006) Placer Order Number/Procedure and (0040,1007) Filler Order Number/Procedure were previously defined in DICOM. They are now retired (See PS3.3 1998).

C.4.12 Imaging Service Request Module

**Table C.4-12
IMAGING SERVICE REQUEST MODULE ATTRIBUTES**

Attribute Name	Tag	Attribute Description
Reason for the Imaging Service Request	(0040,2001)	Reason for the Imaging Service Request. Note: This reason is less specific to the requested procedure than the reason mentioned in the Requested Procedure (0040,1002).
Imaging Service Request Comments	(0040,2400)	User-defined comments on the Imaging Service Request. Note: The Comments attribute is intended to transmit non-structured information, which can be displayed to the operator of the equipment (e.g. Modality).
Requesting Physician	(0032,1032)	Physician who requested the Imaging Service Request.
Referring Physician's Name	(0008,0090)	Patient's primary physician for this Imaging Service Request.
Requesting Service	(0032,1033)	Institutional department where the request initiated.
Accession Number	(0008,0050)	A departmental IS generated number which identifies the order for the Imaging Service Request.
Issue Date of Imaging Service Request	(0040,2004)	Date on which the Imaging Service Request was issued by the requester.
Issue Time of Imaging Service Request	(0040,2005)	Time at which the Imaging Service Request was issued by the requester.
Placer Order Number / Imaging Service Request	(0040,2016)	The order number assigned to the Imaging Service Request by the party placing the order.
Filler Order Number / Imaging Service Request	(0040,2017)	The order number assigned to the Imaging Service Request by the party filling the order.
Order entered by ...	(0040,2008)	The person who entered the Imaging Service Request into an Information System.
Order Enterer's Location	(0040,2009)	The location at which the Imaging Service Request was entered.

Order Callback Phone Number	(0040,2010)	Telephone Number at which additional information can be retrieved.
-----------------------------	-------------	--

- Notes:
- Attributes (0040,2016) and (0040,2017) Placer Order Number and Filler Order Number/Imaging Service Request are intended to convey the corresponding order numbers as defined in HL7, in the case where interoperability with an HL7 environment is the objective.
 - Attributes (0040,2006) and (0040,2007) were previously defined in DICOM. They are now retired (See PS3.3 1998).

C.4.13 Performed Procedure Step Relationship

Table C.4-13 specifies the Attributes used to reference other SOP Classes and other Information Entities of the DICOM real-world model as defined in Section 7.3.1.6.

Table C.4-13
PERFORMED PROCEDURE STEP RELATIONSHIP MODULE ATTRIBUTES

Attribute Name	Tag	Attribute Description
Patient's Name	(0010,0010)	Patient's full legal name.
Patient ID	(0010,0020)	Primary hospital identification number or code for the patient.
Patient's Birth Date	(0010,0030)	Date of birth of the named patient
Patient's Sex	(0010,0040)	Sex of the named Patient. Enumerated Values: M = male F = female O = other
Referenced Patient Sequence	(0008,1120)	Uniquely identifies the Patient SOP Instance.
>Referenced SOP Class UID	(0008,1150)	Uniquely identifies the referenced SOP Class.
>Referenced SOP Instance UID	(0008,1155)	Uniquely identifies the referenced SOP Instance.
Scheduled Step Attributes Sequence	(0040,0270)	Sequence containing attributes that are related to the scheduling of the Procedure Step. The Sequence may have one or more Items.
>Study Instance UID	(0020,000D)	Unique identifier for the Study.
>Referenced Study Sequence	(0008,1110)	Uniquely identifies the Study SOP Instance associated with this Scheduled Procedure Step. This Sequence shall have only one Item.
>>Referenced SOP Class UID	(0008,1150)	Uniquely identifies the SOP Class.
>>Referenced SOP Instance UID	(0008,1155)	Uniquely identifies the SOP Instance.
>Accession Number	(0008,0050)	A departmental IS generated number which identifies the order for the Study.
>Placer Order Number/Imaging Service Request	(0040,2016)	The order number assigned to the Imaging Service Request by the party placing the order.
>Filler Order Number/Imaging Service Request	(0040,2017)	The order number assigned to the Imaging Service Request by the party filling the order.

>Requested Procedure ID	(0040,1001)	Identifier of the related Requested Procedure.
>Requested Procedure Description	(0032,1060)	Institution-generated administrative description or classification of Requested Procedure.
>Scheduled Procedure Step ID	(0040,0009)	Identifier of the related Scheduled Procedure Step.
>Scheduled Procedure Step Description	(0040,0007)	Institution-generated description or classification of the Scheduled Procedure Step to be performed.
>Scheduled Protocol Code Sequence	(0040,0008)	Sequence describing the Scheduled Protocol following a specific coding scheme. This sequence contains one or more Items.
>>Include 'Code Sequence Macro' Table 8.8-1		No Baseline Context ID is defined.

- Notes:
1. The patient information is included in order to relate the Modality Performed Procedure Step SOP Instance to the Study Management SOP Instance and other associated IODs in case the SCU (the modality) is unable to obtain or use the Study Instance UID created by the Information System.
 2. Attributes (0040,2016) and (0040,2017) Placer Order Number and Filler Order Number/Imaging Service Request are intended to convey the corresponding order numbers as defined in HL7, in the case where interoperability with an HL7 environment is the objective.
 3. Attributes (0040,2006) and (0040,2007) were previously defined in DICOM. They are now retired (See PS3.3 1998).
 4. Attributes (0040,1006) Placer Order Number/Procedure and (0040,1007) Filler Order Number/Procedure were previously defined in DICOM. They are now retired (See PS3.3 1998).

C.4.14 Performed Procedure Step Information

Table C.4-14 defines the general attributes which may be used by all specific Procedure Steps.

**Table C.4-14
PERFORMED PROCEDURE STEP INFORMATION MODULE ATTRIBUTES**

Attribute Name	Tag	Attribute Description
Performed Station AE Title	(0040,0241)	AE title of the modality on which the Performed Procedure Step was performed.
Performed Station Name	(0040,0242)	An institution defined name for the modality on which the Performed Procedure Step was performed.
Performed Location	(0040,0243)	Description of the location at which the Performed Procedure Step was performed.
Performed Procedure Step Start Date	(0040,0244)	Date on which the Performed Procedure Step started.
Performed Procedure Step Start Time	(0040,0245)	Time at which the Performed Procedure Step started.
Performed Procedure Step ID	(0040,0253)	User or equipment generated identifier of that part of a Procedure that has been carried out within this step.
Performed Procedure Step End Date	(0040,0250)	Date on which the Performed Procedure Step ended.
Performed Procedure Step End Time	(0040,0251)	Time at which the Performed Procedure Step ended.
Performed Procedure Step Status	(0040,0252)	Contains the state of the Performed Procedure Step. Enumerated Values: IN PROGRESS = Started but not complete DISCONTINUED = Canceled or unsuccessfully terminated COMPLETED = Successfully completed
Performed Procedure Step Description	(0040,0254)	Institution-generated description or classification of the Procedure Step that was performed.
Comments on the Performed Procedure Step	(0040,0280)	User-defined comments on the Performed Procedure Step.
Performed Procedure Type Description	(0040,0255)	A description of the type of procedure performed.
Procedure Code Sequence	(0008,1032)	A sequence that conveys the (single) type of procedure performed.
<i>>Include 'Code Sequence Macro' Table 8.8-1</i>		<i>No Baseline Context ID is defined.</i>

C.4.15 Image Acquisition Results

Table C.4-15 specifies attributes that describe the acquisition of images during the performance of the Procedure Step and that provide references to the Series, Images and Standalone SOP Instances associated with this Modality Performed Procedure Step.

Table C.4-15
IMAGE ACQUISITION RESULTS MODULE ATTRIBUTES

Attribute Name	Tag	Attribute Description
Modality	(0008,0060)	Type of equipment that originally acquired the data used to create the images associated with this Modality Performed Procedure Step. See C.7.3.1.1.1 for Defined Terms. Note: A Modality value in the created SOP Instances may be different from the MPPS Modality value. For example, multiple series may have been created during the MPPS (images, waveforms, softcopy presentation states and/or structured reports) with SOP Instances in different series having different modality values.
Study ID	(0020,0010)	User or equipment generated Study Identifier.
Performed Protocol Code Sequence	(0040,0260)	Sequence describing the Protocol performed for this Procedure Step. This sequence may have zero or more Items.
<i>>Include 'Code Sequence Macro' Table 8.8-1</i>		<i>No Baseline Context ID is defined.</i>
Performed Series Sequence	(0040,0340)	Attributes of the Series that comprise this Modality Performed Procedure Step. The Sequence may have zero or more Items.
<i>>Performing Physician's Name</i>	(0008,1050)	Name of the physician administering this Series.
<i>>Operator's Name</i>	(0008,1070)	Name of the operator who performed this Series.
<i>>Protocol Name</i>	(0018,1030)	User-defined description of the conditions under which the Series was performed. Note: This attribute conveys series-specific protocol identification and may or may not be identical to the one presented in the Performed Protocol Code Sequence (0040,0260).
<i>>Series Instance UID</i>	(0020,000E)	Unique Identifier of the Series.
<i>>Series Description</i>	(0008,103E)	User provided description of the Series
<i>>Retrieve AE Title</i>	(0008,0054)	Title of the DICOM Application Entity where the Images and Standalone SOP Instances in this Series may be retrieved on the network. Note: The duration for which this location remains valid is unspecified.
<i>>Referenced Image Sequence</i>	(0008,1140)	A Sequence that provides reference to one or more sets of Image SOP Class/SOP Instance pairs created during the acquisition of the procedure step. The sequence may have zero or more Items.

>>Referenced SOP Class UID	(0008,1150)	Uniquely identifies the referenced SOP Class.
>>Referenced SOP Instance UID	(0008,1155)	Uniquely identifies the referenced SOP Instance.
>Referenced Non-Image Composite SOP Instance Sequence	(0040,0220)	Uniquely identifies instances, other than images, of any SOP Class that conforms to the DICOM Composite IOD Information Model, such as Waveforms, Presentation States, Structured Reports, LUTs, Curves or Overlays, created during the acquisition of the procedure step. The sequence may have zero or more Items.
>>Referenced SOP Class UID	(0008,1150)	Uniquely identifies the referenced SOP Class.
>>Referenced SOP Instance UID	(0008,1155)	Uniquely identifies the referenced SOP Instance.

C.4.16 Radiation Dose

Table C.4-16 defines the Attributes that may be used to communicate information related to radiation dose values. The attributes are intended to enable the Information System to store Patient exposure to ionizing radiation for legal purposes. Though these attributes are not intended to be used to accurately calculate volume dose distribution, they may serve for some quality control purposes.

This module provides a means to communicate radiation dose values but DICOM does not define any requirements for the accuracy of these values, which may be defined in other professional, national or international standards.

The scope of the attributes contained in this module covers the entire acquisition that comprises the Modality Performed Procedure Step. Attributes that relate to single images, such as mAs or kVP, may be included in the Image IODs. It is beyond the scope of DICOM to define what attributes may be required to calculate or estimate area dose product values.

Table C.4-16
RADIATION DOSE MODULE ATTRIBUTES

Attribute Name	Tag	Attribute Description
Anatomic Structure, Space or Region Sequence	(0008,2229)	Anatomic structure, space or region that has been exposed to ionizing radiation. The sequence may have zero or one Items.
<i>>Include 'Code Sequence Macro' Table 8.8-1</i>		<i>No Baseline Context ID is defined.</i>
Total Time of Fluoroscopy	(0040,0300)	Total duration of X-Ray exposure during fluoroscopy in seconds (pedal time) during this Performed Procedure Step.
Total Number of Exposures	(0040,0301)	Total number of exposures made during this Performed Procedure Step. The number includes non-digital and digital exposures.
Distance Source to Detector (SID)	(0018,1110)	Distance in mm from the source to detector center; SID: Source Image Distance.

Distance Source to Entrance	(0040,0306)	Distance in mm from the source to the surface of the patient closest to the source during this Performed Procedure Step. Note: This may be an estimated value based on assumptions about the patient's body size and habitus.
Entrance Dose	(0040,0302)	Average entrance dose value measured in dGy at the surface of the patient during this Performed Procedure Step. Note: This may be an estimated value based on assumptions about the patient's body size and habitus.
Entrance Dose in mGy	(0040,8302)	Average entrance dose value measured in mGy at the surface of the patient during this Performed Procedure Step. Note: This may be an estimated value based on assumptions about the patient's body size and habitus.
Exposed Area	(0040,0303)	Typical dimension of the exposed area at the detector plane. If Rectangular: row dimension followed by column; if Round: diameter. Measured in mm. Note: This may be an estimated value based on assumptions about the patient's body size and habitus.
Image Area Dose Product	(0018,115E)	Total area-dose-product to which the patient was exposed, accumulated over the complete Performed Procedure Step and measured in dGy*cm*cm, including fluoroscopy. Notes: 1. The sum of the Image Area Dose Product of all images of a Series or a Study may not result in the actual area dose product to which the patient was exposed. 2. This may be an estimated value based on assumptions about the patient's body size and habitus.
Comments on Radiation Dose	(0040,0310)	User-defined comments on any special conditions related to radiation dose encountered during this Performed Procedure Step.
Exposure Dose Sequence	(0040,030E)	Exposure Dose Sequence will contain Total Number of Exposures (0040, 0301) items plus an item for each fluoroscopy episode not already counted as an exposure.
>Radiation Mode	(0018,115A)	Specifies X-Ray radiation mode. Enumerated Values: CONTINUOUS PULSED
>KVp	(0018,0060)	Peak kilo voltage output of the x-ray generator used. An average in the case of fluoroscopy (continuous radiation mode).

>X-ray Tube Current in μ A	(0018,8151)	X-ray Tube Current in μ A. An average in the case of fluoroscopy (continuous radiation mode).
>Exposure Time	(0018,1150)	Time of x-ray exposure or fluoroscopy in msec.
>Filter Type	(0018,1160)	Type of filter(s) inserted into the X-Ray beam (e.g. wedges). See C.7.10 for Defined Terms.
>Filter Material	(0018,7050)	The X-Ray absorbing material used in the filter. May be multi-valued. See C.7.10 for Defined Terms.

- Notes:
1. The Anatomic Region may be deduced from attribute values available within the Modality Worklist Management SOP Class, such as Reason for Service Request, Reasons for Requested Procedure, Scheduled Procedure Step Description and Scheduled Protocol Code Sequence.
 2. The Image Area Dose Product should take into account collimator position and filters, and the value for the Exposed Area should also take into account collimator position. If the equipment does not provide the Entrance Dose, it may be calculated using Area Dose Product, Exposed Area, SID and an assumed body thickness.
 3. The Distance Source to Detector (0018,1110) and Exposed Area (0040,0303) are only meaningful if they remain constant for all acquisitions during this Performed Procedure Step.

C.4.17 Billing and Material Management Codes

The Attributes defined in Table C.4-17 provide a means to transmit billing and material management codes from a modality to an Information System. It is beyond the scope of this Standard to define all the required coding schemes and the relevant codes.

Table C.4-17
BILLING AND MATERIAL MANAGEMENT CODE MODULE ATTRIBUTES

Attribute name	Tag	Attribute Description
Billing Procedure Step Sequence	(0040,0320)	Contains billing codes for the Procedure Type performed within the Procedure Step. The sequence may have zero or more Items.
<i>>Include 'Code Sequence Macro' Table 8.8-1</i>		<i>No Baseline Context ID is defined.</i>
Film Consumption Sequence	(0040,0321)	Information about the film consumption for this Performed Procedure Step. The sequence may have zero or more Items.
>Number of Films	(2100,0170)	Number of films actually printed.
>Medium Type	(2000,0030)	Type(s) of medium on which images were printed. For Defined Terms see Table C.13-1.
>Film Size ID	(2010,0050)	Size(s) of film on which images were printed. For Defined Terms see Table C.13-3.
Billing Supplies and Devices Sequence	(0040,0324)	Chemicals, supplies and devices for billing used in the Performed Procedure Step. The sequence may have one or more Items.
>Billing Item Sequence	(0040,0296)	Code values of chemicals, supplies or devices required for billing. The sequence may have zero or one Items.
<i>>>Include 'Code Sequence Macro' Table 8.8-1</i>		<i>No Baseline Context ID is defined.</i>

>Quantity Sequence	(0040,0293)	Sequence containing the quantity of used chemicals or devices. The sequence may have zero or one Items.
>>Quantity	(0040,0294)	Numerical quantity value.
>>Measuring Units Sequence	(0040,0295)	Unit of measurement. The sequence may have zero or one Items.
>>>Include 'Code Sequence Macro' Table 8.8-1		Baseline Context ID is 82.

C.4.18 General Purpose Scheduled Procedure Step Relationship Module

Table C.4-18

GENERAL PURPOSE SCHEDULED PROCEDURE STEP RELATIONSHIP MODULE ATTRIBUTES

Attribute Name	Tag	Attribute Description
Patient's Name	(0010,0010)	Patient's full legal name.
Patient ID	(0010,0020)	Primary hospital identification number or code for the patient.
Patient's Birth Date	(0010,0030)	Date of birth of the named patient.
Patient's Sex	(0010,0040)	Sex of the named Patient. Enumerated Values: M = male F = female O = other
Referenced Request Sequence	(0040,A370)	The list of Requested Procedures the Procedure Step shall contribute to. One or more Items may be included in the sequence.
>Study Instance UID	(0020,000D)	Unique identifier for the Study.
>Referenced Study Sequence	(0008,1110)	Uniquely identifies the Detached Study Management SOP Instance that represents the Requested Procedure. Zero or one Item may be included in this sequence.
>>Referenced SOP Class UID	(0008,1150)	Uniquely identifies the SOP Class.
>>Referenced SOP Instance UID	(0008,1155)	Uniquely identifies the SOP Instance.
>Accession Number	(0008,0050)	A departmental IS generated number which identifies the Imaging Service Request.
>Requested Procedure Code Sequence	(0032,1064)	A sequence that conveys the Procedure Type of the Requested Procedure. Zero or one Item may be included in this sequence.
>>>Include Code Sequence Macro Table 8.8-1		No Baseline Context ID is defined.
>Placer Order Number / Imaging Service Request	(0040,2016)	The order number assigned to the Imaging Service Request by the party placing the order.

>Filler Order Number / Imaging Service Request	(0040,2017)	The order number assigned to the Imaging Service Request by the party filling the order.
>Requested Procedure ID	(0040,1001)	Identifier which identifies the Requested Procedure in the Imaging Service Request.
>Requested Procedure Description	(0032,1060)	Institution-generated description or classification of the Requested Procedure.
>Reason for the Requested Procedure	(0040,1002)	Reason for requesting this procedure.
>Requested Procedure Comments	(0040,1400)	User-defined comments on the Requested Procedure.
>Confidentiality Code	(0040,1008)	Confidentiality Constraints on the Requested Procedure by the party filling the order.
>Names of Intended Recipients of Results	(0040,1010)	Names of the physicians, who are intended recipients of results.
>Reason for the Imaging Service Request	(0040,2001)	Reason for the Imaging Service Request.
>Imaging Service Request Comments	(0040,2400)	User-defined comments on the Imaging Service Request.
>Requesting Physician	(0032,1032)	Physician who requested the Imaging Service Request.
>Requesting Service	(0032,1033)	Institutional department where the request initiated.
>Issue Date of Imaging Service Request	(0040,2004)	Date on which the Imaging Service Request was issued by the requester.
>Issue Time of Imaging Service Request	(0040,2005)	Time at which the Imaging Service Request was issued by the requester.
>Referring Physician's Name	(0008,0090)	Patient's primary physician for this Imaging Service Request.

C.4.19 General Purpose Scheduled Procedure Step Information Module

**Table C.4-19
GENERAL PURPOSE SCHEDULED PROCEDURE STEP INFORMATION MODULE ATTRIBUTES**

Attribute Name	Tag	Attribute Description
General Purpose Scheduled Procedure Step Status	(0040,4001)	A status that informs the operator and the worklist management system about the progress of the scheduled General Purpose procedure step. Enumerated values are: SCHEDULED, IN PROGRESS, SUSPENDED, COMPLETED, DISCONTINUED. See PS 3.4 for a detailed description of the meaning and usage of these values.

General Purpose Scheduled Procedure Step Priority	(0040,4003)	Scheduled Procedure Step priority. Enumerated values are: HIGH: used to indicate an urgent or emergent Workitem, equivalent to a STAT request. MEDIUM: used to indicate a Workitem that has a priority less than HIGH and higher than LOW. It can be used to further stratify Workitems. LOW: used to indicate a routine or non-urgent Workitem.
Scheduled Procedure Step ID	(0040,0009)	Identifier which identifies the Scheduled General Purpose Procedure Step.
Scheduled Processing Applications Code Sequence	(0040,4004)	The list of processing application instances and/or application types on which the General Purpose Procedure Step is scheduled. Zero or more Items may be included in this sequence.
<i>>Include Code Sequence Macro Table 8.8-1</i>		<i>No Baseline Context ID is defined.</i>
Scheduled Station Name Code Sequence	(0040,4025)	Identifying name within the enterprise of the equipment for which the General Purpose Scheduled Procedure Step is scheduled. The name conveyed in the Code Value (0008,0100) may be the same as the AE Title, but does not have to be. Zero or more Items may be included in this sequence.
<i>>Include Code Sequence Macro Table 8.8-1</i>		<i>No Baseline Context ID is defined.</i>
Scheduled Station Class Code Sequence	(0040,4026)	Class of the equipment for which the General Purpose Scheduled Procedure Step is scheduled. Zero or more Items may be included in this sequence.
<i>>Include Code Sequence Macro Table 8.8-1</i>		<i>No Baseline Context ID is defined.</i>
Scheduled Station Geographic Location Code Sequence	(0040,4027)	Geographic location of the equipment for which the General Purpose Scheduled Procedure Step is scheduled. Zero or more Items may be included in this sequence.
<i>>Include Code Sequence Macro Table 8.8-1</i>		<i>No Baseline Context ID is defined.</i>
Scheduled Human Performers Sequence	(0040,4034)	The list of human performers that are scheduled to be involved or responsible for performing the Workitem in the General Purpose Scheduled Procedure Step. Zero or more Items may be included in this sequence.

>Human Performer Code Sequence	(0040,4009)	Human performer that is involved or responsible for performing the Workitem. Only a single Item shall be permitted in this sequence.
>>Include Code Sequence Macro Table 8.8-1		No Baseline Context ID is defined.
>Human Performer's Name	(0040,4037)	Name of the human performer.
>Human Performer's Organization	(0040,4036)	Organization to which the human performer is accountable for the activities in the Workitem.
Scheduled Procedure Step Start Date and Time	(0040,4005)	Date and time on which the General Purpose Scheduled Procedure Step is scheduled to start.
Expected Completion Date and Time	(0040,4011)	Date on which the Procedure Step is expected to be completed.
Scheduled Workitem Code Sequence	(0040,4018)	A sequence that conveys the code for the Workitem. Only a single Item shall be permitted in this sequence.
>Include Code Sequence Macro Table 8.8-1		Baseline Context ID is CID 9231.
Comments on the Scheduled Procedure Step	(0040,0400)	User-defined comments on the Scheduled Procedure Step.
Referenced Study Component Sequence	(0008,1111)	List of any Modality or General Purpose Performed Procedure Steps, or other Study Components, that may be used to perform the procedure step. This sequence may contain references to performed procedure steps resulting from previous contributions to the performance of the procedure step (e.g. an image processing procedure step interrupted, and completed later). Zero or more Items may be included in this sequence.
>Referenced SOP Class UID	(0008,1150)	Uniquely identifies the SOP Class.
>Referenced SOP Instance UID	(0008,1155)	Uniquely identifies the SOP Instance.

Input Availability Flag	(0040,4020)	<p>Flag that indicates the availability of Composite SOP Instances in the Attribute "Input Information Sequence" (0040,4021) of the General Purpose Scheduled Procedure Step.</p> <p>Enumerated values are:</p> <p style="text-align: center;">PARTIAL COMPLETE</p> <p>The value PARTIAL denotes that the list of Composite SOP Instances may not yet be complete, and additional ones may be added at a later time.</p> <p>The value COMPLETE denotes that all Composite SOP Instances are available and listed.</p> <p>Note: It may happen that the list of Composite SOP Instances is empty when the value of the Input Availability Flag is COMPLETE. In such a case a Workitem has been scheduled that does not require input information.</p>
Input Information Sequence	(0040,4021)	<p>List of Composite SOP Instances that forms the input information needed to perform the scheduled procedure step. See also Input Availability Flag (0040,4020). The same Composite SOP Instance shall not be included in both the Input Information Sequence (0040,4021) and the Relevant Information Sequence (0040,4022).</p> <p>Zero or more Items may be included in this sequence.</p>
<i>>Include 'SOP Instance Reference Macro' Table C.17-3</i>		
Relevant Information Sequence	(0040,4022)	<p>List of Composite SOP Instances that refers to relevant information that is considered pertinent for the performance of the scheduled procedure step. The same Composite SOP Instance shall not be included in both the Input Information Sequence (0040,4021) and the Relevant Information Sequence (0040,4022).</p> <p>Zero or more Items may be included in this sequence.</p>
<i>>Include 'SOP Instance Reference Macro' Table C.17-3</i>		
Study Instance UID	(0020,000D)	<p>Unique Study identification that shall be used for the created Composite SOP Instances resulting from this General Purpose Scheduled Procedure Step.</p> <p>Note: In most cases this will be the same Study Instance UID as for the images in the Input Information Sequence (0040,4021).</p>

Multiple Copies Flag	(0040,4006)	This flag indicates that multiple copies have to be made of a Composite SOP Instance that supports the notion of multiple copies. This includes the SR SOP Class. If set the Study Instance UIDs in the Referenced Request Sequence (0040,A370) shall be used for the created multiple copies. Enumerated Values: Y = Yes N = No
Resulting General Purpose Performed Procedure Steps Sequence	(0040,4015)	List of all General Purpose Performed Procedure Steps that result from the performance of the procedure step. Zero or more Items may be included in this sequence. Note: Initially this list will be empty. New entries will be added when General Purpose Performed Procedure Steps are created by performing devices which are related to this Scheduled Procedure Step. E.g, this sequence may contain the partial results in case a General Purpose Scheduled Procedure Step is discontinued.
>Referenced SOP Class UID	(0008,1150)	Uniquely identifies the SOP Class.
>Referenced SOP Instance UID	(0008,1155)	Uniquely identifies the SOP Instance.
Actual Human Performers Sequence	(0040,4035)	The list of current human performers that are actually involved or responsible for performing the Workitem. Zero or more Items may be included in this sequence. Note: Initially this list will be empty. A list of entries may be created at the status transition of the General Purpose Scheduled Procedure Step Status (0040,4001) to "IN PROGRESS"
>Human Performer Code Sequence	(0040,4009)	Human performer that is involved or responsible for performing the Workitem. Only a single Item shall be permitted in this sequence.
>>Include Code Sequence Macro Table 8.8-1		No Baseline Context ID is defined.
>Human Performer's Name	(0040,4037)	Name of the human performer.
>Human Performer's Organization	(0040,4036)	Organization to which the human performer is accountable for the activities in the Workitem.

C.4.20 General Purpose Performed Procedure Step Relationship Module

Table C.4.20-1 specifies the Attributes used to reference other SOP Classes and other Information Entities of the DICOM real-world model as defined in PS 3.3 Section 7.3.1.11.

Table C.4.20-1

**GENERAL PURPOSE PERFORMED PROCEDURE STEP RELATIONSHIP MODULE
ATTRIBUTES**

Attribute Name	Tag	Attribute Description
Patient's Name	(0010,0010)	Patient's full legal name.
Patient ID	(0010,0020)	Primary hospital identification number or code for the patient.
Patient's Birth Date	(0010,0030)	Date of birth of the named patient.
Patient's Sex	(0010,0040)	Sex of the named Patient. Enumerated Values: M = male F = female O = other
Referenced Request Sequence	(0040,A370)	The list of Requested Procedures the Procedure Step shall contribute to. Zero or more Items may be included in the sequence.
>Study Instance UID	(0020,000D)	Unique identifier for the Study.
>Referenced Study Sequence	(0008,1110)	Uniquely identifies the Study SOP Instance associated with this Scheduled Procedure Step. Only a single Item shall be permitted in this sequence.
>>Referenced SOP Class UID	(0008,1150)	Uniquely identifies the SOP Class.
>>Referenced SOP Instance UID	(0008,1155)	Uniquely identifies the SOP Instance.
>Accession Number	(0008,0050)	A departmental IS generated number which identifies the order for the Study.
>Requested Procedure Code Sequence	(0032,1064)	A sequence that conveys the Procedure Type of the Requested Procedure. Zero or one Item may be included in this sequence.
>> <i>Include Code Sequence Macro Table 8.8-1</i>		<i>No Baseline Context ID is defined.</i>
>Placer Order Number/Imaging Service Request	(0040,2016)	The order number assigned to the Imaging Service Request by the party placing the order.
>Filler Order Number/Imaging Service Request	(0040,2017)	The order number assigned to the Imaging Service Request by the party filling the order.
>Requested Procedure ID	(0040,1001)	Identifier of the related Requested Procedure.
>Requested Procedure Description	(0032,1060)	Institution-generated administrative description or classification of Requested Procedure.
Referenced General Purpose Scheduled Procedure Step Sequence	(0040,4016)	Uniquely identifies the General Purpose Scheduled Procedure Step SOP Instance associated with this General Purpose Performed Procedure Step. Zero or more Items may be included in this sequence.
>Referenced SOP Class UID	(0008,1150)	Uniquely identifies the SOP Class.
>Referenced SOP Instance UID	(0008,1155)	Uniquely identifies the SOP Instance.
>Referenced General Purpose	(0040,4023)	Transaction UID (0008,1195) used in the N-ACTION

Scheduled Procedure Step Transaction UID		transaction that requested the transition to the IN PROGRESS state for the referenced General Purpose Scheduled Procedure Step.
--	--	---

C.4.21 General Purpose Performed Procedure Step Information Module

Table C.4.21-1

GENERAL PURPOSE PERFORMED PROCEDURE STEP INFORMATION MODULE ATTRIBUTES

Attribute Name	Tag	Attribute Description
Actual Human Performers Sequence	(0040,4035)	The list of human performers that were actually involved in or responsible for performing this General Purpose Performed Procedure Step. Zero or more Items may be included in this sequence.
>Human Performer Code Sequence	(0040,4009)	Human performer that is actually involved or responsible for performing the General Purpose Performed Procedure Step. Only a single Item shall be permitted in this sequence.
>>Include Code Sequence Macro Table 8.8-1		No Baseline Context ID is defined.
>Human Performer's Name	(0040,4037)	Name of the human performer.
>Human Performer's Organization	(0040,4036)	Organization to which the human performer is accountable for the activities in the General Purpose Performed Procedure Step.
Performed Station Name Code Sequence	(0040,4028)	Name within the enterprise of the equipment that created the General Purpose Performed Procedure Step. This name may be the same as the AE Title, but does not have to be. Zero or one Item may be included in this sequence.
>Include Code Sequence Macro Table 8.8-1		No Baseline Context ID is defined.
Performed Station Class Code Sequence	(0040,4029)	Class of the equipment that created the General Purpose Performed Procedure Step. Zero or one Item may be included in this sequence.
>Include Code Sequence Macro Table 8.8-1		No Baseline Context ID is defined.
Performed Station Geographic Location Code Sequence	(0040,4030)	Geographic location of the equipment that created General Purpose Performed Procedure Step. Zero or one Item may be included in this sequence.
>Include Code Sequence Macro Table 8.8-1		No Baseline Context ID is defined.
Performed Processing Applications Code Sequence	(0040,4007)	The list of processing application instances and/or application types on which the General Purpose Performed Procedure Step is executed. Zero or more Items may be included in this sequence.
>Include Code Sequence Macro Table 8.8-1		No Baseline Context ID is defined.
Performed Procedure Step Start	(0040,0244)	Date on which the General Purpose Performed

Date		Procedure Step started.
Performed Procedure Step Start Time	(0040,0245)	Time at which the General Purpose Performed Procedure Step started.
Performed Procedure Step ID	(0040,0253)	User or equipment generated identifier of that part of a Procedure that has been carried out within this procedure step.
Performed Procedure Step End Date	(0040,0250)	Date on which the General Purpose Performed Procedure Step ended.
Performed Procedure Step End Time	(0040,0251)	Time at which the General Purpose Performed Procedure Step ended.
General Purpose Performed Procedure Step Status	(0040,4002)	Contains the state of the Performed Procedure Step. Enumerated Values: IN PROGRESS = Started but not complete DISCONTINUED = Canceled or unsuccessfully terminated COMPLETED = Successfully completed
Performed Procedure Step Description	(0040,0254)	Institution-generated description or classification of the Procedure Step that was performed.
Comments on the Performed Procedure Step	(0040,0280)	User-defined comments on the Performed Procedure Step. This attribute shall not be used as a substitute for the code meaning in the Performed Workitem Code Sequence (0040,4019).
Performed Workitem Code Sequence	(0040,4019)	A sequence that conveys the (single) type of procedure performed. Only a single Item shall be permitted in this sequence.
>Include Code Sequence Macro Table 8.8-1		Baseline Context ID is CID 9231.

C.4.22 General Purpose Results

Table C.4.22-1 specifies attributes that describe the creation of results during the performance of the General Purpose Procedure Step and that provide references to the Results and Structured Reporting SOP Instances associated with this General Purpose Performed Procedure Step.

**Table C.4.22-1
GENERAL PURPOSE RESULTS MODULE ATTRIBUTES**

Attribute Name	Tag	Attribute Description
Output Information Sequence	(0040,4033)	A Sequence that provides reference to one or more Composite SOP instances, that identify the Structured Reports or other results created. Zero or more Items may be included in this sequence.
>Include 'SOP Instance Reference Macro' Table C.17-3		
Requested Subsequent Workitem Code Sequence	(0040,4031)	A Sequence that provides suggested next Workitems, based on the produced results. Note: This Attribute may also be used in case a step has been done incorrectly and should be

		redone. Zero or more Items may be included in this sequence
>Include Code Sequence Macro Table 8.8-1		Baseline Context ID is CID 9231.
Non-DICOM Output Code Sequence	(0040,4032)	A Sequence that describes any non-DICOM output produced as results. Zero or more Items may be included in this sequence.
>Include Code Sequence Macro Table 8.8-1		Baseline Context ID is CID 9232.

C.5 RESULTS MODULES

The following Sections specify Modules relevant to a real world diagnostic imaging results performed on a patient.

C.5.1 Results Relationship Module

Table C.5-1 defines the Attributes which reference SOP Instances Subordinate or Superior to this SOP Class in the Naming Hierarchy.

**Table C.5-1
RESULTS RELATIONSHIP MODULE ATTRIBUTES**

Attribute Name	Tag	Attribute Description
Referenced Study Sequence	(0008,1110)	Uniquely identifies the Study SOP Instances associated with the Results SOP Instance.
>Referenced SOP Class UID	(0008,1150)	Uniquely identifies the referenced SOP Class.
>Referenced SOP Instance UID	(0008,1155)	Uniquely identifies the referenced SOP Instance.
Referenced Interpretation Sequence	(4008,0050)	Uniquely identifies the report SOP Instances and amendment SOP Instances which comprise the results SOP Instance. Zero or more Items may be included in this Sequence.
>Referenced SOP Class UID	(0008,1150)	Uniquely identifies the referenced SOP Class.
>Referenced SOP Instance UID	(0008,1155)	Uniquely identifies the referenced SOP Instance.

C.5.2 Results Identification Module

Table C.5-2 defines the Attributes relevant to identifying results.

**Table C.5-2
RESULTS IDENTIFICATION MODULE ATTRIBUTES**

Attribute Name	Tag	Attribute Description
Results ID	(4008,0040)	Healthcare provider generated number used to reference the results
Results ID Issuer	(4008,0042)	Name of healthcare provider which issued the results ID

C.5.3 Results Impressions Module

Table C.5-3 defines the Attributes relevant to the result's impressions.

Table C.5-3
RESULTS IMPRESSION MODULE ATTRIBUTES

Attribute Name	Tag	Attribute Description
Impressions	(4008,0300)	Short impressions summarizing the full results
Results Comments	(4008,4000)	User-defined comments about the results

C.6 INTERPRETATION MODULES

The following Sections specify Modules relevant to a real world results interpretation.

C.6.1 Interpretation Relationship Module

Table C.6-1 defines the Attributes which reference SOP Instances Subordinate or Superior to this SOP Class in the Naming Hierarchy.

Table C.6-1
INTERPRETATION RELATIONSHIP MODULE ATTRIBUTES

Attribute Name	Tag	Attribute Description
Referenced Results Sequence	(0008,1100)	Uniquely identifies the results SOP Instances for which the interpretation SOP Instance applies. Only a single Item shall be permitted in this Sequence.
>Referenced SOP Class UID	(0008,1150)	Uniquely identifies the referenced SOP Class.
>Referenced SOP Instance ID	(0008,1155)	Uniquely identifies the referenced SOP Instance.

C.6.2 Interpretation Identification Module

Table C.6-2 defines the Attributes relevant to identifying an interpretation.

Table C.6-2
INTERPRETATION IDENTIFICATION MODULE ATTRIBUTES

Attribute Name	Tag	Attribute Description
Interpretation ID	(4008,0200)	Healthcare provider generated number used to reference the interpretation
Interpretation ID Issuer	(4008,0202)	Name of healthcare provider which issued the interpretation ID

C.6.3 Interpretation State Module

Table C.6-3 defines the Attributes relevant to the state of an interpretation.

**Table C.6-3
INTERPRETATION STATE MODULE ATTRIBUTES**

Attribute Name	Tag	Attribute Description
Interpretation Type ID	(4008,0210)	The type of interpretation. Defined Terms: REPORT = Report AMENDMENT = Amendment
Interpretation Status ID	(4008,0212)	An Enumerated Value element used to track production status of the interpretation. Enumerated Values: CREATED = Interpretation Created RECORDED = Interpretation captured in a format external to the information system which handles reports. TRANSCRIBED = Interpretation converted into or entered in the internal format of the information system which handles reports. APPROVED = Interpretation Approved

C.6.4 Interpretation Recording Module

Table C.6-4 defines the Attributes relevant to the recording of an interpretation.

**Table C.6-4
INTERPRETATION RECORDING MODULE ATTRIBUTES**

Attribute Name	Tag	Attribute Description
Interpretation Recorded Date	(4008,0100)	Date interpretation was dictated or entered
Interpretation Recorded Time	(4008,0101)	Time interpretation was dictated or entered
Interpretation Recorder	(4008,0102)	Name of the person who recorded the interpretation
Reference to Recorded Sound	(4008,0103)	A reference used to identify or locate the sound recording of the interpretation

C.6.5 Interpretation Transcription Module

Table C.6-5 defines the Attributes relevant to the transcription of an interpretation recording.

**Table C.6-5
INTERPRETATION TRANSCRIPTION MODULE ATTRIBUTES**

Attribute Name	Tag	Attribute Description
Interpretation Transcription Date	(4008,0108)	Date interpretation was transcribed.
Interpretation Transcription Time	(4008,0109)	Time interpretation was transcribed.
Interpretation Transcriber	(4008,010A)	Name of person who transcribed the interpretation.
Interpretation Text	(4008,010B)	Text of the interpretation.
Interpretation Author	(4008,010C)	Name of author of interpretation.

C.6.6 Interpretation Approval Module

Table C.6-6 defines the Attributes relevant to the approval of an interpretation.

**Table C.6-6
INTERPRETATION APPROVAL MODULE ATTRIBUTES**

Attribute Name	Tag	Attribute Description
Interpretation Approver Sequence	(4008,0111)	Identifies the approvers of the interpretation. Zero or more Items may be included in this Sequence.
>Interpretation Approval Date	(4008,0112)	Date the report or amendment was approved.
>Interpretation Approval Time	(4008,0113)	Time the report or amendment was approved.
>Physicians Approving Interpretation	(4008,0114)	Physician approving the report or amendment.
Interpretation Diagnosis Description	(4008,0115)	Diagnosis produced by the Physician.
Interpretation Diagnosis Codes Sequence	(4008,0117)	A sequence that conveys the interpretation diagnosis. One or more Items may be included in this Sequence.
<i>>Include 'Code Sequence Macro' Table 8.8-1</i>		<i>No Baseline Context ID is defined.</i>
Results Distribution List Sequence	(4008,0118)	Names and addresses of persons to receive a copy of the report and amendments. Zero or more Items may be included in this Sequence.
>Distribution Name	(4008,0119)	Name of one of the persons to receive a copy of the report and amendments.
>Distribution Address	(4008,011A)	Address of one of the persons to receive a copy of the report and amendments.

C.7 COMMON COMPOSITE IMAGE IOD MODULES

This Section defines the Modules which are common to all Composite Image IODs.

C.7.1 Common Patient IE Modules

The following Patient IE Module is common to all Composite Image IODs which reference the Patient IE.

C.7.1.1 Patient Module

Table C.7-1 specifies the Attributes of the Patient that describe and identify the Patient who is the subject of a diagnostic Study. This Module contains Attributes of the patient that are needed for diagnostic interpretation of the Image and are common for all studies performed on the patient. It contains Attributes that are also included in the Patient Modules in Section C.2.

**Table C.7-1
PATIENT MODULE ATTRIBUTES**

Attribute Name	Tag	Type	Attribute Description
Patient's Name	(0010,0010)	2	Patient's full name.
Patient ID	(0010,0020)	2	Primary hospital identification number or code for the patient.
Patient's Birth Date	(0010,0030)	2	Birth date of the patient.
Patient's Sex	(0010,0040)	2	Sex of the named patient. Enumerated Values: M = male F = female O = other
Referenced Patient Sequence	(0008,1120)	3	A sequence which provides reference to a Patient SOP Class/Instance pair. Only a single Item shall be permitted in this Sequence.
>Referenced SOP Class UID	(0008,1150)	1C	Uniquely identifies the referenced SOP Class. Required if Referenced Patient Sequence (0008,1120) is sent.
>Referenced SOP Instance UID	(0008,1155)	1C	Uniquely identifies the referenced SOP Instance. Required if Referenced Patient Sequence (0008,1120) is sent.
Patient's Birth Time	(0010,0032)	3	Birth time of the Patient.
Other Patient IDs	(0010,1000)	3	Other identification numbers or codes used to identify the patient.
Other Patient Names	(0010,1001)	3	Other names used to identify the patient.
Ethnic Group	(0010,2160)	3	Ethnic group or race of the patient.
Patient Comments	(0010,4000)	3	User-defined additional information about the patient.

C.7.1.2 Specimen Identification Module

Table C.7-2 specifies the Attributes which identify a Specimen.

**Table C.7-2
SPECIMEN IDENTIFICATION MODULE ATTRIBUTES**

Attribute Name	Tag	Type	Attribute Description
Specimen Accession Number	(0040,050A)	1	A departmental Information System identifier which identifies the Accession. See Section C.7.1.2.1.1 for further explanation.
Specimen Sequence	(0040,0550)	2	Detailed description of one or more specimens. Zero or more Items may be included in this Sequence.

>Specimen Identifier	(0040,0551)	2C	A departmental information system identifier for the Specimen. See Section C.7.1.2.1.2 for further explanation. Required if a sequence item is present.
>Specimen Type Code Sequence	(0040,059A)	2C	Specimen Type. Only a single Item shall be permitted in this Sequence. Required if a sequence item is present and Specimen Identifier (0040,0551) is sent.
>>Include 'Code Sequence Macro' Table 8.8-1		Baseline Context IDs are defined in 37	
>Slide Identifier	(0040,06FA)	2C	Identifier of the Slide. Required if a sequence item is present and the Specimen is a Slide.

C.7.1.2.1 Specimen Module Attributes

C. 7.1.2.1.1 Specimen Accession Number

Specimen Accession Number (0040,06CA) is the primary identifier of the Specimen.

Note: Specimen Accession Number (0040,050A) identifies tissue or fluid obtained from a Patient in a Specimen-harvest procedure. This Attribute was created to differentiate Accession Numbers, as used in Anatomic Pathology to identify specimens, from other uses of the term "Accession Number" in Information Systems. The Specimen Accession Number (0040,050A) is typically unique within the scope of the institution in which the Accession is performed. An Accession may contain multiple Specimens. Typically, an Accession contains the Specimens obtained in one Specimen-harvest procedure and submitted by one Requesting Physician. However, multiple Specimen-harvest procedures may be involved.

C.7.1.2.1.2 Specimen Identifier

Specimen Identifier (0040,050A) may be used to convey a slide number, a block number, or other secondary identifier of the Specimen.

Note: The Specimen Identifier (0040,0551) is typically unique within the scope of the institution in which the related Accession is performed. However, a value of Specimen Identifier (0040,0551) does not always exist. For example, it is common practice in some Anatomic Pathology departments to use a Specimen Identifier (0040,0551) to identify specimen-containers or blocks only if multiple containers or blocks are submitted for a single Accession. Therefore, Specimen Identifier (0040,0551) is modeled as a Type 2 Attribute.

C.7.2 Common Study IE Modules

The following Study IE Modules are common to all Composite Image IODs which reference the Study IE. These Module contain Attributes of the patient and study that are needed for diagnostic interpretation of the image. They contain Attributes that are also in the Patient Modules in Section C.2 and Study Modules in Section C.4.

C.7.2.1 General Study Module

Table C.7-3 specifies the Attributes which describe and identify the Study performed upon the Patient.

**Table C.7-3
GENERAL STUDY MODULE ATTRIBUTES**

Attribute Name	Tag	Type	Attribute Description
Study Instance UID	(0020,000D)	1	Unique identifier for the Study.
Study Date	(0008,0020)	2	Date the Study started.
Study Time	(0008,0030)	2	Time the Study started.
Referring Physician's Name	(0008,0090)	2	Patient's referring physician
Study ID	(0020,0010)	2	User or equipment generated Study identifier.
Accession Number	(0008,0050)	2	A RIS generated number which identifies the order for the Study.
Study Description	(0008,1030)	3	Institution-generated description or classification of the Study (component) performed.
Physician(s) of Record	(0008,1048)	3	Physician(s) who are responsible for overall patient care at time of Study (see Section C.7.3.1 for Performing Physician)
Name of Physician(s) Reading Study	(0008,1060)	3	Physician(s) reading the Study.
Referenced Study Sequence	(0008,1110)	3	A sequence which provides reference to a Study SOP Class/Instance pair. The sequence may have zero or more Items.
>Referenced SOP Class UID	(0008,1150)	1C	Uniquely identifies the referenced SOP Class. Required if Referenced Study Sequence (0008,1110) is sent.
>Referenced SOP Instance UID	(0008,1155)	1C	Uniquely identifies the referenced SOP Instance. Required if Referenced Study Sequence (0008,1110) is sent.
Procedure Code Sequence	(0008,1032)	3	A Sequence that conveys the type of procedure performed. One or more Items may be included in this Sequence.
>Include 'Code Sequence Macro' Table 8.8-1		No Baseline Context ID is defined.	

Note: The model used for application of attributes related to different functions of Physicians involved in the care is as follows:

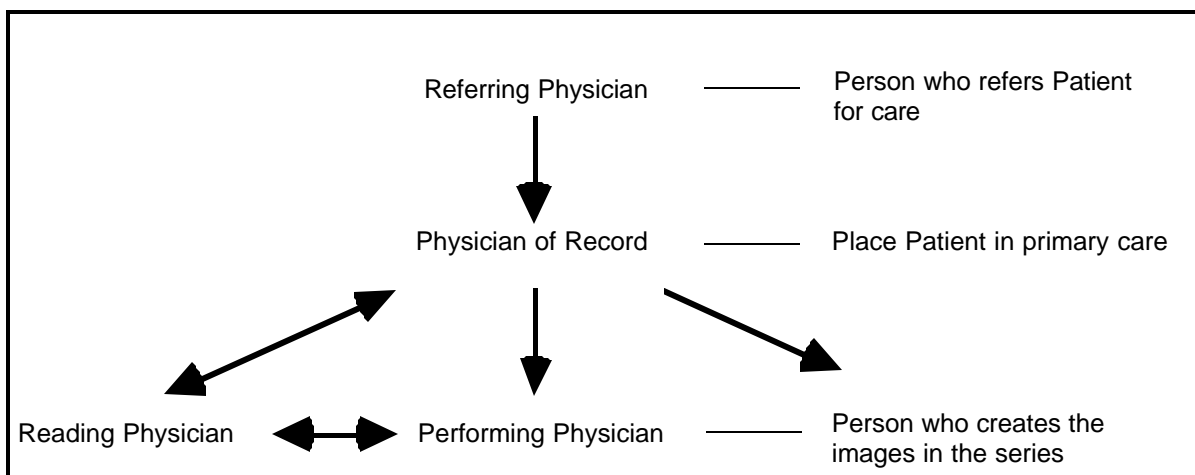

There can be an overlap of functions provided by any given physician. In this case, the field entries would convey the same physician name under different roles.

C.7.2.2 Patient Study Module

Table C.7-4 defines Attributes that provide information about the Patient at the time the Study was performed.

Table C.7-4
PATIENT STUDY MODULE ATTRIBUTES

Attribute Name	Tag	Type	Attribute Description
Admitting Diagnoses Description	(0008,1080)	3	Description of the admitting diagnosis (diagnoses)
Admitting Diagnoses Code Sequence	(0008,1084)	3	A sequence that conveys the admitting diagnosis (diagnoses). One or more Items may be included in this Sequence.
<i>>Include 'Code Sequence Macro' Table 8.8-1</i>		<i>No Baseline Context ID is defined.</i>	
Patient's Age	(0010,1010)	3	Age of the Patient.
Patient's Size	(0010,1020)	3	Length or size of the Patient, in meters.
Patient's Weight	(0010,1030)	3	Weight of the Patient, in kilograms.
Occupation	(0010,2180)	3	Occupation of the Patient.
Additional Patient's History	(0010,21B0)	3	Additional information about the Patient's medical history.

C.7.3 Common Series IE Modules

The following Series IE Modules are common to all Composite Image IODs which reference the Series IE.

C.7.3.1 General Series Module

Table C.7-5 specifies the Attributes which identify and describe general information about the Series within a Study.

**Table C.7-5
GENERAL SERIES MODULE ATTRIBUTES**

Attribute Name	Tag	Type	Attribute Description
Modality	(0008,0060)	1	Type of equipment that originally acquired the data used to create the images in this Series. See C.7.3.1.1.1 for Defined Terms.
Series Instance UID	(0020,000E)	1	Unique identifier of the Series.
Series Number	(0020,0011)	2	A number that identifies this Series.
Laterality	(0020,0060)	2C	Laterality of (paired) body part examined. Required if the body part examined is a paired structure and Image Laterality (0020,0062) is not sent. Enumerated Values: R = right L = left Note: Some IODs support Image Laterality (0020,0062) at the Image level, which can provide a more comprehensive mechanism for specifying the laterality of the body part(s) being examined.
Series Date	(0008,0021)	3	Date the Series started.
Series Time	(0008,0031)	3	Time the Series started.
Performing Physicians' Name	(0008,1050)	3	Name of the physicians administering the Series.
Protocol Name	(0018,1030)	3	User-defined description of the conditions under which the Series was performed. Note: This attribute conveys series-specific protocol identification and may or may not be identical to the one presented in the Performed Protocol Code Sequence (0040,0260).
Series Description	(0008,103E)	3	User provided description of the Series
Operators' Name	(0008,1070)	3	Technologist(s) supporting the Series.
Referenced Study Component Sequence	(0008,1111)	3	Uniquely identifies the Study Component SOP Instance or Modality Performed Procedure Step SOP Instance to which the Series is related. The Sequence shall have zero or one Item.
>Referenced SOP Class UID	(0008,1150)	1C	Uniquely identifies the referenced SOP Class. Required if Referenced Study Component Sequence (0008,1111) is sent.
>Referenced SOP Instance UID	(0008,1155)	1C	Uniquely identifies the referenced SOP Instance. Required if Referenced Study Component Sequence (0008,1111) is sent.

Body Part Examined	(0018,0015)	3	Text description of the part of the body examined. Defined Terms: SKULL, CSPINE, TSPINE, LSPINE, SSPINE, COCCYX, CHEST, CLAVICLE, BREAST, ABDOMEN, PELVIS, HIP, SHOULDER, ELBOW, KNEE, ANKLE, HAND, FOOT, EXTREMITY, HEAD, HEART, NECK, LEG, ARM, JAW Note: Some IODs support the Anatomic Region Sequence (0008,2218), which can provide a more comprehensive mechanism for specifying the body part being examined.
Patient Position	(0018,5100)	2C	Patient position descriptor relative to the equipment. Required for CT and MR images. See C.7.3.1.1.2. for Defined Terms and further explanation.
Smallest Pixel Value in Series	(0028,0108)	3	The minimum value of all images in this Series.
Largest Pixel Value in Series	(0028,0109)	3	The maximum value of all images in this Series.
Request Attributes Sequence	(0040,0275)	3	Sequence that contains attributes from the Imaging Service Request. The sequence may have one or more Items.
>Requested Procedure ID	(0040,1001)	1C	Identifier which identifies the Requested Procedure in the Imaging Service Request. Required if Sequence Item is present.
>Scheduled Procedure Step ID	(0040,0009)	1C	Identifier which identifies the Scheduled Procedure Step. Required if Sequence Item is present.
>Scheduled Procedure Step Description	(0040,0007)	3	Institution-generated description or classification of the Scheduled Procedure Step to be performed.
>Scheduled Protocol Code Sequence	(0040,0008)	3	Sequence describing the Scheduled Protocol following a specific coding scheme. This sequence contains one or more Items.
>>Include 'Code Sequence Macro' Table 8.8-1		No Baseline Context ID is defined.	
Performed Procedure Step ID	(0040,0253)	3	Identification of that part of a Procedure that has been carried out within this step.
Performed Procedure Step Start Date	(0040,0244)	3	Date on which the Performed Procedure Step started.
Performed Procedure Step Start Time	(0040,0245)	3	Time on which the Performed Procedure Step started.
Performed Procedure Step Description	(0040,0254)	3	Institution-generated description or classification of the Procedure Step that was performed.

Performed Protocol Code Sequence	(0040,0260)	3	Sequence describing the Protocol performed for this Procedure Step. One or more Items may be included in this Sequence.
>Include 'Code Sequence Macro' Table 8.8-1		No Baseline Context ID is defined.	
Comments on the Performed Procedure Step	(0040,0280)	3	User-defined comments on the Performed Procedure Step.

- Notes:
1. If the Modality Performed Procedure Step SOP Class is supported as an SCU by a Storage SCU, the SCU is strongly encouraged to support the attribute Referenced Study Component Sequence (0008,1111). This attribute references the Modality Performed Procedure Step SOP Instance, and extraction of this Attribute from an image may allow retrieval of the Modality Performed Procedure Step SOP Instance.
 2. If the Modality does not conform to the Modality Performed Procedure Step SOP Class, it is still advisable to include the attributes Performed Procedure Step Start Date (0040,0244), Performed Procedure Step Start Time (0040,0245) and Performed Procedure Step Description (0040,0254) into the Image IODs.

C.7.3.1.1 General Series Attribute Descriptions

C.7.3.1.1.1 Modality

Defined Terms for the Modality (0008,0060) are:

CR = Computed Radiography	CT = Computed Tomography
MR = Magnetic Resonance	NM = Nuclear Medicine
US = Ultrasound	OT = Other
BI = Biomagnetic imaging	CD = Color flow Doppler
DD = Duplex Doppler	DG = Diaphanography
ES = Endoscopy	LS = Laser surface scan
MA = Magnetic resonance angiography	MS = Magnetic resonance spectroscopy
PT = Positron emission tomography (PET)	RG = Radiographic imaging (conventional film/screen)
ST = Single-photon emission computed tomography (SPECT)	TG = Thermography
XA = X-Ray Angiography	RF = Radio Fluoroscopy
RTIMAGE = Radiotherapy Image	RTDOSE = Radiotherapy Dose
RTSTRUCT = Radiotherapy Structure Set	RTPLAN = Radiotherapy Plan
RTRECORD = RT Treatment Record	HC = Hard Copy
DX = Digital Radiography	MG = Mammography
IO = Intra-oral Radiography	PX = Panoramic X-Ray
GM = General Microscopy	SM = Slide Microscopy
XC = External-camera Photography	PR = Presentation State
AU = Audio	ECG = Electrocardiography
EPS = Cardiac Electrophysiology	HD = Hemodynamic Waveform
SR = SR Document	IVUS = Intravascular Ultrasound

Retired Defined Terms for the Modality (0008,0060) are:

DS = Digital Subtraction Angiography (retired)	CF = Cinefluorography (retired)
DF = Digital fluoroscopy (retired)	VF = Videofluorography (retired)
AS = Angioscopy	CS = Cystoscopy
EC = Echocardiography	LP = Laparoscopy
FA = Fluorescein angiography	CP = Culposcopy
DM = Digital microscopy	FS = Fundoscopy

- Note:
1. The XA modality incorporates the retired modality DS.
 2. The RF modality incorporates the retired modalities CF, DF, VF.
 3. The modality listed in the Modality Data Element (0008,0060) may not match the name of the IOD in which it appears. For example, a SOP instance from XA IOD may list the RF modality when an RF implementation produces an XA object.

C.7.3.1.1.2 Patient Position

Patient Position (0018,5100) specifies the position of the patient relative to the imaging equipment space. This attribute is intended for annotation purposes only. It does not provide an exact mathematical relationship of the patient to the imaging equipment.

When facing the front of the imaging equipment, Head First is defined as the patient's head being positioned toward the front of the imaging equipment. Feet First is defined as the patient's feet being positioned toward the front of the imaging equipment. Prone is defined as the patient's face being positioned in a downwards (gravity) direction. Supine is defined as the patient's face being in an upwards direction. Decubitus Right is defined as the patient's right side being in a downwards direction. Decubitus Left is defined as the patient's left side being in a downwards direction.

The Defined Terms are:

HFP = Head First-Prone	HFS = Head First-Supine
HFDR = Head First-Decubitus Right	HFDL = Head First-Decubitus Left
FFDR = Feet First-Decubitus Right	FFDL = Feet First-Decubitus Left
FFP = Feet First-Prone	FFS = Feet First-Supine

C.7.4 Common Frame Of Reference Information Entity Modules

C.7.4.1 Frame Of Reference Module

Table C.7-6 specifies the Attributes necessary to uniquely identify a frame of reference which insures the spatial relationship of Images within a Series. It also allows Images across multiple Series to share the same Frame Of Reference. This Frame Of Reference (or coordinate system) shall be constant for all Images related to a specific Frame Of Reference.

When a Frame of Reference is identified, it is not important how the Patient is positioned relative to the imaging equipment or where the origin of the Frame Of Reference is located. It is important that the position of the Patient and the origin are constant in relationship to a specific Frame Of Reference.

- Note:
- Since the criteria used to group images into a Series is application specific, it is possible for imaging applications to define multiple Series within a Study which share the same imaging space. Previous versions of the DICOM Standard specified that all images within the Series

must be spatially related. However, insufficient information was available to determine if multiple Series within a Study were spatially related.

Table C.7-6
FRAME OF REFERENCE MODULE ATTRIBUTES

Attribute Name	Tag	Type	Attribute Description
Frame of Reference UID	(0020,0052)	1	Uniquely identifies the frame of reference for a Series. See C.7.4.1.1.1 for further explanation.
Position Reference Indicator	(0020,1040)	2	Part of the patient's anatomy used as a reference, such as the iliac crest, orbital-medial, sternal notch, symphysis pubis, xiphoid, lower coastal margin, external auditory meatus. See C.7.4.1.1.2 for further explanation.

C.7.4.1.1 Frame Of Reference Attribute Descriptions

C.7.4.1.1.1 Frame Of Reference UID

The Frame of Reference UID (0020,0052) shall be used to uniquely identify a frame of reference for a series. Each series shall have a single Frame of Reference UID. However, multiple Series within a Study may share a Frame of Reference UID. All images in a Series which share the same Frame of Reference UID shall be spatially related to each other.

- Notes:
1. Previous versions of this Standard defined a Data Element "Location" which has been retired. Frame of Reference UID provides a completely unambiguous identification of the image location reference used to indicate position.
 2. A common Frame of Reference UID may be used to spatially relate localizer images with a set of axial images, however, in some cases (eg. multiple localizer images being related to a single set of axial images) a common Frame of Reference UID may not be sufficient. The Referenced Image Sequence (0008,1140) provides an unambiguous method for relating localizer images.

C.7.4.1.1.2 Position Reference Indicator

The Position Reference Indicator (0020,1040) specifies the part of the patient's anatomy which was used as an anatomical reference point associated with a specific Frame of Reference UID. The Position Reference Indicator may or may not coincide with the origin of the fixed frame of reference related to the Frame of Reference UID.

The Position Reference Indicator shall be used only for annotation purposes and is not intended to be used as a mathematical spatial reference.

- Note: The Position Reference Indicator may be sent zero length when it has no meaning, for example, when the Frame of Reference Module is required to relate mammographic images of the breast acquired without releasing breast compression, but where there is no meaningful anatomical reference point as such.

C.7.4.2 Synchronization Module

Table C.7-7 specifies the Attributes necessary to uniquely identify a frame of reference which establishes the temporal relationship of SOP Instances. A synchronized environment may be established based on a shared time of day clock, and/or on a shared trigger event or synchronization waveform channel.

Note: Within a synchronized environment, different devices may use the shared data differently. An electrical pulse, for example, may be treated as a trigger event by one device (e.g., an x-ray imaging system), but may be recorded as a synchronization waveform by another device (e.g., a hemodynamics system).

Table C.7-7
Synchronization Module Attributes

Attribute Name	Tag	Type	Attribute Description
Synchronization Frame of Reference UID	(0020,0200)	1	UID of common synchronization environment. See C.7.4.2.1.1.
Synchronization Trigger	(0018,106A)	1	Data acquisition synchronization with external equipment Enumerated Values: SOURCE - this equipment provides synchronization channel or trigger to other equipment EXTERNAL - this equipment receives synchronization channel or trigger from other equipment PASSTHRU - this equipment receives synchronization channel or trigger and forwards it NO TRIGGER - data acquisition not synchronized by common channel or trigger
Trigger Source or Type	(0018,1061)	3	Specifies equipment ID of trigger source and/or type of trigger
Synchronization Channel	(0018,106C)	1C	Identifier of waveform channel which records the synchronization channel or trigger, see C.7.4.2.1.3. Required if synchronization channel or trigger is encoded in a waveform in this SOP Instance
Acquisition Time Synchronized	(0018,1800)	1	Acquisition Datetime (0008,002A) synchronized with external time reference. Enumerated Values: Y, N See C.7.4.2.1.4
Time Source	(0018,1801)	3	ID of equipment or system providing time reference
Time Distribution Protocol	(0018,1802)	3	Method of time distribution used to synchronize this equipment. Defined Terms: NTP - Network Time Protocol IRIG - InterRange Instrumentation Group GPS - Global Positioning System

C.7.4.2.1 Synchronization Attribute Descriptions

C.7.4.2.1.1 Synchronization Frame of Reference UID

A set of equipment may share a common acquisition synchronization environment, which is identified by a Synchronization Frame of Reference UID. All SOP Instances which share the same Synchronization Frame of Reference UID shall be temporally related to each other. If a Synchronization Frame of Reference UID is present, all SOP Instances in the Series must share the same Frame of Reference.

- Notes:
1. The Synchronization Frame of Reference UID defines an equipment synchronization environment, and does not need to be changed for each unrelated acquisition. SOP Instances may therefore share a Synchronization Frame of Reference UID, but be clinically unrelated (e.g., apply to different patients).
 2. When a synchronization environment is recalibrated, a new UID must be issued.
 3. The method of distributing the Synchronization Frame of Reference UID to multiple devices is not specified.

C.7.4.2.1.2 Time Source and Time Distribution Protocol

Time may originate with a primary source (e.g., a national standards bureau) and be distributed through a chain of secondary distribution systems until reaching the imaging equipment. Time Distribution Protocol (0018,1802) specifies the immediate (last link) method used by the equipment to receive time from the immediately prior Time Source (0018,1801). It does not specify the ultimate time reference from which the Time Source may derive its synchronization.

C.7.4.2.1.3 Synchronization Channel

The Synchronization Channel (0018,106C) is specified as a pair of values (M,C), where the first value is the ordinal of the sequence item of the Waveform Sequence (5400, 0100) attribute (i.e., the Multiplex Group), and the second value is the ordinal of the sequence item of the Channel Definition Sequence (003A,0200) attribute (i.e., the Waveform Channel Number) within the multiplex group.

C.7.4.2.1.4 Acquisition Time Synchronized

The Acquisition Time Synchronized (0018,1800) attribute specifies whether the Acquisition Datetime (0008,002A) attribute of the Waveform Identification Module or the General Image Module represents an accurate synchronized timestamp for the acquisition of the waveform and/or image data. For triggered multi-frame images, the Acquisition Datetime applies to the trigger for the first image frame (see attribute Image Trigger Delay (0018.1067) in the Cine Module).

- Note: The degree of precision of the Acquisition Datetime and its accuracy relative to the external clock are not specified, but need to be appropriate for the clinical application.

C.7.5 Common Equipment IE Modules

The following Equipment IE Module is common to all Composite Image IODs which reference the Equipment IE.

C.7.5.1 General Equipment Module

Table C.7-8 specifies the Attributes which identify and describe the piece of equipment which produced a Series of Images.

Table C.7-8
GENERAL EQUIPMENT MODULE ATTRIBUTES

Attribute Name	Tag	Type	Attribute Description
Manufacturer	(0008,0070)	2	Manufacturer of the equipment that produced the digital images.
Institution Name	(0008,0080)	3	Institution where the equipment is located that produced the digital images.
Institution Address	(0008,0081)	3	Mailing address of the institution where the equipment is located that produced the digital images.
Station Name	(0008,1010)	3	User defined name identifying the machine that produced the digital images.
Institutional Department Name	(0008,1040)	3	Department in the institution where the equipment is located that produced the digital images
Manufacturer's Model Name	(0008,1090)	3	Manufacturer's model number of the equipment that produced the digital images.
Device Serial Number	(0018,1000)	3	Manufacturer's serial number of the equipment that produced the digital images.
Software Versions	(0018,1020)	3	Manufacturer's designation of software version of the equipment that produced the digital images.
Spatial Resolution	(0018,1050)	3	The inherent limiting resolution in mm of the equipment for high contrast objects for the data gathering and reconstruction technique chosen. If variable across the images of the series, the value at the image center.
Date of Last Calibration	(0018,1200)	3	Date when the image acquisition device calibration was last changed in any way. Multiple entries may be used for additional calibrations at other times. See C.7.5.1.1.1 for further explanation.
Time of Last Calibration	(0018,1201)	3	Time when the image device was last changed in any way. Multiple entries may be used. See C.7.5.1.1.1 for further explanation.
Pixel Padding Value	(0028,0120)	3	Value of pixels added to non-rectangular image to pad to rectangular format. See C.7.5.1.1.2 for further explanation. Note: The Value Representation of this Attribute is determined by the value of Pixel Representation (0028,0103).

C.7.5.1.1 General Equipment Attribute Descriptions

C.7.5.1.1.1 Date Of Last Calibration, Time Of Last Calibration

Date of Last Calibration (0018,1200) and Time of Last Calibration (0018,1201) are used to convey the date and time of calibration. The Attribute Date of Last Calibration (0018,1200) may be supported alone, however, Time of Last Calibration (0018,1201) Attribute has no meaning unless Attribute Date of Last Calibration (0018,1200) is also supported. The order for each Attribute shall be from the oldest date/time to the most recent date/time. When the Attributes are both supported they shall be provided as pairs.

C.7.5.1.1.2 Pixel Padding Value

Pixel Padding Value (0028,0120) is used to pad non-rectangular images to rectangular format. The native format of some images is not rectangular. It is common for devices with this format to pad the images to the rectangular format required by the DICOM Standard with a specific pixel value that is not contained in the native image. This attribute specifies the value of this padding value.

- Notes:
1. When the relationship between pixel value and X-Ray Intensity is unknown, it is recommended that the following values be used to pad with black:
0 if Photometric Interpretation (0028,0004) is MONOCHROME2.
 $2^{\text{BitsStored}} - 1$ if Photometric Interpretation (0028,0004) is MONOCHROME1.
 2. When the relationship between pixel value and X-Ray Intensity is known (for example as defined by Pixel Intensity Relationship (0028,1040) and Pixel Intensity relationship Sign (0028,1041)), it is recommended that a value equivalent to air be used.

C.7.6 Common IE Modules

The following Image IE Modules are common to all Composite Image IODs which reference the Image IE.

C.7.6.1 General Image Module

Table C.7-9 specifies the Attributes which identify and describe an image within a particular series.

**Table C.7-9
GENERAL IMAGE MODULE ATTRIBUTES**

Attribute Name	Tag	Type	Attribute Description
Instance Number	(0020,0013)	2	A number that identifies this image. Note: This Attribute was named Image Number in earlier versions of this Standard.
Patient Orientation	(0020,0020)	2C	Patient direction of the rows and columns of the image. Required if image does not require Image Orientation (Patient) (0020,0037) and Image Position (Patient) (0020,0032). See C.7.6.1.1.1 for further explanation.
Content Date	(0008,0023)	2C	The date the image pixel data creation started. Required if image is part of a series in which the images are temporally related. Note: This Attribute was formerly known as Image Date.
Content Time	(0008,0033)	2C	The time the image pixel data creation started. Required if image is part of a series in which the images are temporally related.
Image Type	(0008,0008)	3	Image identification characteristics. See C.7.6.1.1.2 for Defined Terms and further explanation.
Acquisition Number	(0020,0012)	3	A number identifying the single continuous gathering of data over a period of time which resulted in this image.
Acquisition Date	(0008,0022)	3	The date the acquisition of data that resulted in this image started
Acquisition Time	(0008,0032)	3	The time the acquisition of data that resulted in this image started
Acquisition Datetime	(0008,002A)	3	The date and time that the acquisition of data that resulted in this image started. Note: The synchronization of this time with an external clock is specified in the Synchronization Module in Acquisition Time Synchronized (0018,1800).
Referenced Image Sequence	(0008,1140)	3	A sequence which provides reference to a set of Image SOP Class/Instance identifying other images significantly related to this image (e.g. post-localizer CT image or Mammographic biopsy or partial view images).

>Referenced SOP Class UID	(0008,1150)	1C	Uniquely identifies the referenced SOP Class. Required if Referenced Image Sequence (0008,1140) is sent.
>Referenced SOP Instance UID	(0008,1155)	1C	Uniquely identifies the referenced SOP Instance. Required if Reference Image Sequence (0008,1140) is sent.
>Referenced Frame Number	(0008,1160)	3	References one or more image frames of a Multi-frame Image SOP Instance, identifying which frames are significantly related to this image.
Derivation Description	(0008,2111)	3	A text description of how this image was derived. See C.7.6.1.1.3 for further explanation.
Source Image Sequence	(0008,2112)	3	A Sequence which identifies the set of Image SOP Class/Instance pairs of the Images which were used to derive this Image. Zero or more Items may be included in this Sequence. See C.7.6.1.1.4 for further explanation.
>Referenced SOP Class UID	(0008,1150)	1C	Uniquely identifies the referenced SOP Class. Required if Source Image Sequence (0008,2112) is sent.
>Referenced SOP Instance UID	(0008,1155)	1C	Uniquely identifies the referenced SOP Instance. Required if Source Image Sequence (0008,2112) is sent.
>Referenced Frame Number	(0008,1160)	3	References one or more image frames of a Multi-frame Image SOP Instance, identifying which frames were used to derive this image.
Images in Acquisition	(0020,1002)	3	Number of images that resulted from this acquisition of data
Image Comments	(0020,4000)	3	User-defined comments about the image
Quality Control Image	(0028,0300)	3	Indicates whether or not this image is a quality control or phantom image. Enumerated Values: YES NO If this Attribute is absent, then the image may or may not be a quality control or phantom image.

Burned In Annotation	(0028,0301)	3	<p>Indicates whether or not image contains sufficient burned in annotation to identify the patient and date the image was acquired .</p> <p>Enumerated Values:</p> <p>YES NO</p> <p>If this Attribute is absent, then the image may or may not contain burned in annotation.</p>
Lossy Image Compression	(0028,2110)	3	<p>Specifies whether an Image has undergone lossy compression.</p> <p>Enumerated Values:</p> <p>00 = Image has NOT been subjected to lossy compression.</p> <p>01 = Image has been subjected to lossy compression.</p> <p>See C.7.6.1.1.5</p>
Lossy Image Compression Ratio	(0028,2112)	3	<p>Describes the approximate lossy compression ratio(s) that have been applied to this image.</p> <p>See C.7.6.1.1.5 for further explanation.</p> <p>May be multivalued if successive lossy compression steps have been applied.</p> <p>Notes: 1. For example, a compression ratio of 30:1 would be described in this Attribute with a single value of 30.</p> <p>2. For historical reasons, the lossy compression ratio should also be described in Derivation Description (0008,2111).</p>
Icon Image Sequence	(0088,0200)	3	<p>This icon image is representative of the Image.</p>
> Image Pixel Module			<p>See C.7.6.1.1.6 for further explanation.</p>

Presentation LUT Shape	(2050,0020)	3	<p>When present, specifies an identity transformation for the Presentation LUT such that the output of all grayscale transformations, if any, are defined to be in P-Values.</p> <p>Enumerated Values are:</p> <p>IDENTITY - output is in P-Values - shall be used if Photometric Interpretation (0028,0004) is MONOCHROME2 or any color photometric interpretation.</p> <p>INVERSE - output after inversion is in P-Values - shall be used if Photometric Interpretation (0028,0004) is MONOCHROME1.</p> <p>When this attribute is used with a color photometric interpretation then the luminance component is in P-Values.</p>
------------------------	-------------	---	---

C.7.6.1.1 General Image Attribute Descriptions

C.7.6.1.1.1 Patient Orientation

The Patient Orientation (0020,0020) relative to the image plane shall be specified by two values that designate the anatomical direction of the positive row axis (left to right) and the positive column axis (top to bottom). The first entry is the direction of the rows, given by the direction of the last pixel in the first row from the first pixel in that row. The second entry is the direction of the columns, given by the direction of the last pixel in the first column from the first pixel in that column.

Anatomical direction shall be designated by the capital letters: A (anterior), P (posterior), R (right), L (left), H (head), F (foot). Each value of the orientation attribute shall contain at least one of these characters. If refinements in the orientation descriptions are to be specified, then they shall be designated by one or two additional letters in each value. Within each value, the letters shall be ordered with the principal orientation designated in the first character.

C.7.6.1.1.2 Image Type

The Image Type (0008,0008) Attribute identifies important image identification characteristics. These characteristics are:

- a. Pixel Data Characteristics
 - 1. is the image an ORIGINAL Image; an image whose pixel values are based on original or source data
 - 2. is the image a DERIVED Image; an image whose pixel values have been derived in some manner from the pixel value of one or more other images
- b. Patient Examination Characteristics
 - 1. is the image a PRIMARY Image; an image created as a direct result of the Patient examination
 - 2. is the image a SECONDARY Image; an image created after the initial Patient examination
- c. Modality Specific Characteristics

- d. Implementation specific identifiers; other implementation specific identifiers shall be documented in an implementation's conformance statement.

The Image Type attribute is multi-valued and shall be provided in the following manner:

- a. Value 1 shall identify the Pixel Data Characteristics; Enumerated Values for the Pixel Data Characteristics are:
 - ORIGINAL identifies an Original Image
 - DERIVED identifies a Derived Image
- b. Value 2 shall identify the Patient Examination Characteristics; Enumerated Values for the Patient Examination Characteristics are:
 - PRIMARY identifies a Primary Image
 - SECONDARY identifies a Secondary Image
- c. Value 3 shall identify any Image IOD specific specialization (optional)
- d. Other Values which are implementation specific (optional)

If the pixel data of the derived Image is different from the pixel data of the source images and this difference is expected to affect professional interpretation of the image, the Derived Image shall have a UID different than all the source images.

C.7.6.1.1.3 Derivation Description

If an Image is identified to be a derived image (see C.7.6.1.1.2 Image Type), Derivation Description (0008,2111) is an optional text description of the way the image was derived. It may be used whether or not the Source Image Sequence (0008,2112) is provided. It may also be used in cases when the Derived Image pixel data is not significantly changed from one of the source images and the SOP Instance UID of the Derived Image is the same as the one used for the source image.

- Note: Examples of Derived Images which would normally be expected to affect professional interpretation and would thus have a new UID include:
- a. images resulting from image processing of another image (e.g. unsharp masking),
 - b. a multiplanar reformatted CT image,
 - c. a DSA image derived by subtracting pixel values of one image from another.
 - d. an image that has been decompressed after having been compressed with a lossy compression algorithm. To ensure that the user has the necessary information about the lossy compression, the approximate compression ratio may be included in Derivation Description (0008,2111).

An example of a Derived Image that would normally not be expected to affect professional interpretation and thus would not require a new UID is an image that has been padded with additional rows and columns for more display purposes.

C.7.6.1.1.4 Source image sequence

If an Image is identified to be a Derived image (see C.7.6.1.1.2 Image Type), Source Image Sequence (0008,2112) is an optional list of Referenced SOP Class UID (0008,1150)/ Referenced SOP Instance UID (0008,1150) pairs which identify the source images used to create the Derived image. It may be used whether or not there is a description of the way the image was derived in Derivation Description (0008,2111).

C.7.6.1.1.5 Lossy Image Compression

The Attribute Lossy Image Compression (0028,2110) conveys that the Image has undergone lossy compression. It provides a means to record that the Image has been compressed (at a point in its lifetime) with a lossy algorithm and changes have been introduced into the pixel data. Once the value has been set to "01", it shall not be reset.

Note: If an image is compressed with a lossy algorithm, the attribute Lossy Image Compression (0028,2110) is set to "01". Subsequently, if the image is decompressed and transferred in uncompressed format, this attribute value remains "01".

The value of the Lossy Image Compression (0028,2110) Attribute in SOP Instances containing multiple frames in which one or more of the frames have undergone lossy compression shall be "01".

Note: It is recommended that the applicable frames be noted in the Attribute Derivation Description (0008,2111).

If Lossy Image Compression (0028,2110) is set to "01", Value 1 of the Attribute Image Type (0008,0008) shall be set to DERIVED, and the Image shall receive a new SOP Instance UID.

Note: 1. It is recommended that the approximate compression ratio be provided in the Attribute Derivation Description (0008,2111). Furthermore, it is recommended that Derivation Description (0008,2111) be used to indicate when pixel data changes might affect professional interpretation. (see C.7.6.1.1.3).
2. The attribute Lossy Image Compression (0028,2110) is defined as Type 3 for backward compatibility with existing IODs. It is expected to be required (i.e., defined as Type 1C) for new Image IODs and for existing IODs which undergo a major revision (e.g. a new IOD is specified).

C.7.6.1.1.6 Icon Image Sequence

An Icon Image may be used as a key representative of an Image. It is defined as a Sequence which contains a single Item encapsulating the Data Set made of the Data Elements of the Icon Image. The Data Elements are defined by the Image Pixel Module (see Section C.7.6.3). The restrictions defined in Section F.7 shall apply.

C.7.6.2 Image Plane Module

Table C.7-10 specifies the Attributes which define the transmitted pixel array of a two dimensional image plane.

Note: In previous versions of this Standard, image position and image orientation were specified relative to a specific equipment coordinate system. This equipment coordinate system was not fully defined and a number of ambiguities existed. The equipment based coordinate system has been retired and replaced by the patient based coordinate system defined in this Module.

**Table C.7-10
IMAGE PLANE MODULE ATTRIBUTES**

Attribute Name	Tag	Type	Attribute Description
Pixel Spacing	(0028,0030)	1	Physical distance in the patient between the center of each pixel, specified by a numeric pair - adjacent row spacing (delimiter) adjacent column spacing in mm.
Image Orientation (Patient)	(0020,0037)	1	The direction cosines of the first row and the first column with respect to the patient. See C.7.6.2.1.1 for further explanation.
Image Position (Patient)	(0020,0032)	1	The x, y, and z coordinates of the upper left hand corner (center of the first voxel transmitted) of the image, in mm. See C.7.6.2.1.1 for further explanation.
Slice Thickness	(0018,0050)	2	Nominal slice thickness, in mm.
Slice Location	(0020,1041)	3	Relative position of exposure expressed in mm. C.7.6.2.1.2 for further explanation.

C.7.6.2.1 Image Plane Attribute Descriptions

C.7.6.2.1.1 Image Position And Image Orientation

The Image Position (0020,0032) specifies the x, y, and z coordinates of the upper left hand corner of the image; it is the center of the first voxel transmitted. Image Orientation (0020,0037) specifies the direction cosines of the first row and the first column with respect to the patient. These Attributes shall be provide as a pair. Row value for the x, y, and z axes respectively followed by the Column value for the x, y, and z axes respectively.

The direction of the axes is defined fully by the patient's orientation. The x-axis is increasing to the left hand side of the patient. The y-axis is increasing to the posterior side of the patient. The z-axis is increasing toward the head of the patient.

The patient based coordinate system is a right handed system, i.e. the vector cross product of a unit vector along the positive x-axis and a unit vector along the positive y-axis is equal to a unit vector along the positive z-axis.

Note: If a patient lies parallel to the ground, face-up on the table, with his feet-to-head direction same as the front-to-back direction of the imaging equipment, the direction of the axes of this patient based coordinate system and the equipment based coordinate system in previous versions of this Standard will coincide.

C.7.6.2.1.2 Slice Location

The Slice Location (0020,1041) is defined as the relative position of exposure expressed in mm. This information is relative to an unspecified implementation specific reference point.

C.7.6.3 Image Pixel Module

Table C.7-11 specified the Attributes that describe the pixel data of the image.

Table C.7-11
IMAGE PIXEL MODULE ATTRIBUTES

Attribute Name	Tag	Type	Attribute Description
Samples per Pixel	(0028,0002)	1	Number of samples (planes) in this image. See C.7.6.3.1.1 for further explanation.
Photometric Interpretation	(0028,0004)	1	Specifies the intended interpretation of the pixel data. See C.7.6.3.1.2 for further explanation.
Rows	(0028,0010)	1	Number of rows in the image.
Columns	(0028,0011)	1	Number of columns in the image
Bits Allocated	(0028,0100)	1	Number of bits allocated for each pixel sample. Each sample shall have the same number of bits allocated. See PS 3.5 for further explanation.
Bits Stored	(0028,0101)	1	Number of bits stored for each pixel sample. Each sample shall have the same number of bits stored. See PS 3.5 for further explanation.
High Bit	(0028,0102)	1	Most significant bit for pixel sample data. Each sample shall have the same high bit. See PS 3.5 for further explanation.
Pixel Representation	(0028,0103)	1	Data representation of the pixel samples. Each sample shall have the same pixel representation. Enumerated Values: 0000H = unsigned integer. 0001H = 2's complement
Pixel Data	(7FE0,0010)	1	A data stream of the pixel samples which comprise the Image. See C.7.6.3.1.4 for further explanation.
Planar Configuration	(0028,0006)	1C	Indicates whether the pixel data are sent color-by-plane or color-by-pixel. Required if Samples per Pixel (0028,0002) has a value greater than 1. See C.7.6.3.1.3 for further explanation.
Pixel Aspect Ratio	(0028,0034)	1C	Ratio of the vertical size and horizontal size of the pixels in the image specified by a pair of integer values where the first value is the vertical pixel size, and the second value is the horizontal pixel size. Required if the aspect ratio is not 1\1 and the Image Plane Module is not applicable to this Image. See C.7.6.3.1.7.
Smallest Image Pixel Value	(0028,0106)	3	The minimum actual pixel value encountered in this image.
Largest Image Pixel Value	(0028,0107)	3	The maximum actual pixel value encountered in this image.

Red Palette Color Lookup Table Descriptor	(0028,1101)	1C	Specifies the format of the Red Palette Color Lookup Table Data (0028,1201) Required if Photometric Interpretation (0028,0004) has a value of PALETTE COLOR or ARGB. See C.7.6.3.1.5 for further explanation.
Green Palette Color Lookup Table Descriptor	(0028,1102)	1C	Specifies the format of the Green Palette Color Lookup Table Data (0028,1202) Required if Photometric Interpretation (0028,0004) has a value of PALETTE COLOR or ARGB. See C.7.6.3.1.5 for further explanation.
Blue Palette Color Lookup Table Descriptor	(0028,1103)	1C	Specifies the format of the Blue Palette Color Lookup Table Data (0028,1203) Required if Photometric Interpretation (0028,0004) has a value of PALETTE COLOR or ARGB. See C.7.6.3.1.5 for further explanation.
Red Palette Color Lookup Table Data	(0028,1201)	1C	Red Palette Color Lookup Table Data. Required if Photometric Interpretation (0028,0004) has a value of PALETTE COLOR or ARGB. See C.7.6.3.1.6 for further explanation.
Green Palette Color Lookup Table Data	(0028,1202)	1C	Green Palette Color Lookup Table Data. Required if Photometric Interpretation (0028,0004) has a value of PALETTE COLOR or ARGB. See C.7.6.3.1.6 for further explanation.
Blue Palette Color Lookup Table Data	(0028,1203)	1C	Blue Palette Color Lookup Table Data. Required if Photometric Interpretation (0028,0004) has a value of PALETTE COLOR or ARGB. See C.7.6.3.1.6 for further explanation.

C.7.6.3.1 Image Pixel Attribute Descriptions

C.7.6.3.1.1 Samples Per Pixel

Samples per Pixel (0028,0002) is the number of separate planes in this image. One, three, and four image planes are defined. Other numbers of image planes are allowed, but their meaning is not defined by this Standard.

For monochrome (gray scale) and palette color images, the number of planes is 1. For RGB and other three vector color models, the value of this attribute is 3. For ARGB and other four vector color models, the value of this attribute is 4.

All image planes shall have the same number of Rows (0028,0010), Columns (0028,0011), Bits Allocated (0028,0100), Bits Stored (0028,0101), High Bit (0028,0102), Pixel Representation (0028,0103), and Pixel Aspect Ratio (0028,0034).

The data in each pixel may be represented as a "Composite Pixel Code". If Samples Per Pixel is one, the Composite Pixel Code is just the "n" bit pixel sample, where "n" = Bits Allocated. If

Samples Per Pixel is greater than one, Composite Pixel Code is a “k” bit concatenation of samples, where “k” = Bits Allocated multiplied by Samples Per Pixel, and with the sample representing the vector color designated first in the Photometric Interpretation name comprising the most significant bits of the Composite Pixel Code, followed in order by the samples representing the next vector colors, with the sample representing the vector color designated last in the Photometric Interpretation name comprising the least significant bits of the Composite Pixel Code. For example, for Photometric Interpretation = “RGB”, the most significant “Bits Allocated” bits contain the Red sample, the next “Bits Allocated” bits contain the Green sample, and the least significant “Bits Allocated” bits contain the Blue sample.

C.7.6.3.1.2 Photometric Interpretation

The value of Photometric Interpretation (0028,0004) specifies the intended interpretation of the image pixel data.

See PS 3.5 for restrictions imposed by compressed Transfer Syntaxes.

The following values are defined. Other values are permitted but the meaning is not defined by this Standard.

MONOCHROME1 = Pixel data represent a single monochrome image plane. The minimum sample value is intended to be displayed as white after any VOI gray scale transformations have been performed. See PS 3.4. This value may be used only when Samples per Pixel (0028,0002) has a value of 1.

MONOCHROME2 = Pixel data represent a single monochrome image plane. The minimum sample value is intended to be displayed as black after any VOI gray scale transformations have been performed. See PS 3.4. This value may be used only when Samples per Pixel (0028,0002) has a value of 1.

PALETTE COLOR = Pixel data describe a color image with a single sample per pixel (single image plane). The pixel value is used as an index into each of the Red, Blue, and Green Palette Color Lookup Tables (0028,1101-1103&1201-1203). This value may be used only when Samples per Pixel (0028,0002) has a value of 1. When the Photometric Interpretation is Palette Color; Red, Blue, and Green Palette Color Lookup Tables shall be present.

RGB = Pixel data represent a color image described by red, green, and blue image planes. The minimum sample value for each color plane represents minimum intensity of the color. This value may be used only when Samples per Pixel (0028,0002) has a value of 3.

HSV = Pixel data represent a color image described by hue, saturation, and value image planes. The minimum sample value for each HSV plane represents a minimum value of each vector. This value may be used only when Samples per Pixel (0028,0002) has a value of 3.

ARGB = Pixel data represent a color image described by red, green, blue, and alpha image planes. The minimum sample value for each RGB plane represents minimum intensity of the color. The alpha plane is passed through Palette Color Lookup Tables. If the alpha pixel value is greater than 0, the red, green, and blue lookup table values override the red, green, and blue, pixel plane colors. This value may be used only when Samples per Pixel (0028,0002) has a value of 4.

CMYK = Pixel data represent a color image described by cyan, magenta, yellow, and black image planes. The minimum sample value for each CMYK plane represents a minimum intensity of the color. This value may be used only when Samples per Pixel (0028,0002) has a value of 4.

YBR_FULL = Pixel data represent a color image described by one luminance (Y) and two chrominance planes (C_B and C_R). This photometric interpretation may be used only when samples

per pixel (0028,0002) has a value of 3. Black is represented by Y equal to zero. The absence of color is represented by both C_B and C_R values equal to half full scale.

Note: In the case where the Bits Allocated (0028,0100) has value of 8 half full scale is 128.

In the case where Bits allocated (0028,0100) has a value of 8 then the following equations convert between RGB and $YC_B C_R$ Photometric Interpretation.

$$\begin{aligned}
 Y &= + .2990R + .5870G + .1140B \\
 C_B &= - .1687R - .3313G + .5000B + 128 \\
 C_R &= + .5000R - .4187G - .0813B + 128
 \end{aligned}$$

Note: The above is based on CCIR Recommendation 601-2 dated 1990

YBR_FULL_422 = The same as YBR_FULL except that the C_B and C_R values are sampled horizontally at half the Y rate and as a result there are half as many C_B and C_R values as Y values.

This photometric Interpretation is only allowed with Planar Configuration (0028,0006) equal to 0000. Two Y values shall be stored followed by one C_B and one C_R value. The C_B and C_R values shall be sampled at the location of the first of the two Y values. For each Row of Pixels, the first C_B and C_R samples shall be at the location of the first Y sample. The next C_B and C_R samples shall be at the location of the third Y sample etc.

Note: This subsampling is often referred to as cosited sampling.

YBR_PARTIAL_422 = The same as YBR_FULL_422 except that:

1. black corresponds to $Y = 16$;
2. Y is restricted to 220 levels (i.e. the maximum value is 235);
3. C_B and C_R each has a minimum value of 16;
4. C_B and C_R are restricted to 225 levels (i.e. the maximum value is 240);
5. lack of color is represented by C_B and C_R equal to 128.

In the case where Bits Allocated (0028,0100) has value of 8 then the following equations convert between RGB and YBR_PARTIAL_422 Photometric Interpretation

$$\begin{aligned}
 Y &= + .2568R + .5041G + .0979B + 16 \\
 C_B &= - .1482R - .2910G + .4392B + 128 \\
 C_R &= + .4392R - .3678G - .0714B + 128
 \end{aligned}$$

Note: The above is based on CCIR Recommendation 601-2 dated 1990.

C.7.6.3.1.3 Planar Configuration

Planar Configuration (0028,0006) indicates whether the color pixel data are sent color-by-plane or color-by-pixel. This Attribute shall be present if Samples per Pixel (0028,0002) has a value greater than 1. It shall not be present otherwise.

Enumerated Values:

- 000 = The sample values for the first pixel are followed by the sample values for the second pixel, etc. For RGB images, this means the order of the pixel values sent shall be R1,

G1, B1, R2, G2, B2, ..., etc. For HSV images, this means the order of the pixel values sent shall be H1, S1, V1, H2, S2, V2, ... etc. For ARGB images, this means the order of the pixel values sent shall be A1, R1, G1, B1, A2, R2, G2, B2, ... etc. For CMYK images, this means the order of the pixel values sent shall be C1, M1, Y1, K1, C2, M2, Y2, K2, ... etc.

001 = Each color plane shall be sent contiguously. For RGB images, this means the order of the pixel values sent is R1, R2, R3, ..., G1, G2, G3, ..., B1, B2, B3, etc. For HSV images, this means the order of the pixel values sent is H1, H2, H3, ..., S1, S2, S3, ..., V1, V2, V3, etc. For ARGB images, this means the order of the pixel values sent is A1, A2, A3, ..., R1, R2, R3, ..., G1, G2, G3, ... B1, B2, B3... etc. For CMYK images, this means the order of the pixel values sent is C1, C2, C3, ..., M1, M2, M3, ..., Y1, Y2, Y3, ..., K1, K2, K3... etc.

C.7.6.3.1.4 Pixel Data

Pixel Data (7FE0,0010) for this image. The order of pixels sent for each image plane is left to right, top to bottom, ie., the upper left pixel (labeled 1,1) is sent first followed by the remainder of row 1, followed by the first pixel of row 2 (labeled 2,1) then the remainder of row 2 and so on.

For multi-plane images see Planar Configuration (0028,0006) in this Section.

C.7.6.3.1.5 Palette Color Lookup Table Descriptor

The three values of Palette Color Lookup Table Descriptor (0028,1101-1103) describe the format of the Lookup Table Data in the corresponding Data Element (0028,1201-1203) or (0028,1221-1223).

The first value is the number of entries in the lookup table. When the number of table entries is equal to 2^{16} then this value shall be 0.

The second value is the first stored pixel value mapped. This pixel value is mapped to the first entry in the Lookup Table Data. All image pixel values less than the first value mapped are also mapped to the first entry in the Lookup Table Data. An image pixel value one greater than the first value mapped is mapped to the second entry in the Lookup Table Data. Subsequent image pixel values are mapped to the subsequent entries in the Lookup Table Data up to an image pixel value equal to number of entries + first value mapped - 1 which is mapped to the last entry in the Lookup Table Data. Image pixel values greater than or equal to number of entries + first value mapped are also mapped to the last entry in the Lookup Table Data.

The third value specifies the number of bits for each entry in the Lookup Table Data. It shall take the value of 8 or 16. The LUT Data shall be stored in a format equivalent to 8 or 16 bits allocated where the high bit is equal to bits allocated-1.

When the Palette Color Lookup Table Descriptor (0028,1101-1103) are used as part of the Palette Color Lookup Table Module, the third value shall be equal to 16.

- Notes:
1. A value of 16 indicates the Lookup Table Data will range from (0,0,0) minimum intensity to (65535,65535,65535) maximum intensity.
 2. Since the Palette Color Lookup Table Descriptor (0028,1101-1103) Attributes are multi-valued, in an Explicit VR Transfer Syntax, only one value representation (US or SS) may be specified, even though the first and third values are always by definition interpreted as unsigned. The explicit VR actually used is dictated by the VR needed to represent the second value, which will be consistent with Pixel Representation (0028,0103).

C.7.6.3.1.6 Palette Color Lookup Table Data

Palette Color Lookup Table Data (0028,1201-1203) contain the lookup table data corresponding to the Lookup Table Descriptor (0028,1101-1103).

Palette color values must always be scaled across the full range of available intensities. This is indicated by the fact that there are no bits stored and high bit values for palette color data.

Note: For example, if there are 16 bits per entry specified and only 8 bits of value are truly used then the 8 bit intensities from 0 to 255 must be scaled to the corresponding 16 bit intensities from 0 to 65535. To do this for 8 bit values, simply replicate the value in both the most and least significant bytes.

These lookup tables shall be used only when there is a single sample per pixel (single image plane) in the image.

These lookup tables are required when the value of Photometric Interpretation (0028,0004) is Palette Color. The semantics of these lookup tables is not defined otherwise.

C.7.6.3.1.7 Pixel Aspect Ratio

The pixel aspect ratio is the ratio of the vertical size and horizontal size of the pixels in the image specified by a pair of integer values where the first value is the vertical pixel size, and the second value is the horizontal pixel size. To illustrate, consider the following example pixel size:

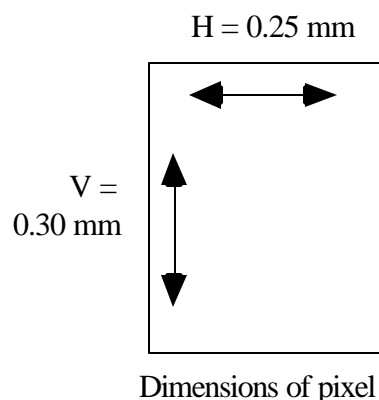

Pixel Aspect Ratio = Vertical Size \ Horizontal Size = 0.30 mm \ 0.25 mm. Thus the Pixel Aspect Ratio could be represented as the multivalued integer string "6\5", "60\50", or any equivalent integer ratio.

C.7.6.4 Contrast/Bolus Module

Table C.7-12 specifies the Attributes that describe the contrast /bolus used in the acquisition of the Image.

Table C.7-12
CONTRAST/BOLUS MODULE ATTRIBUTES

Attribute Name	Tag	Type	Attribute Description
Contrast/Bolus Agent	(0018,0010)	2	Contrast or bolus agent
Contrast/Bolus Agent Sequence	(0018,0012)	3	Sequence that identifies the contrast agent.
>Include 'Code Sequence Macro' Table 8.8-1		Baseline Context ID is 12.	
Contrast/Bolus Route	(0018,1040)	3	Administration route of contrast agent
Contrast/Bolus Administration Route Sequence	(0018,0014)	3	Sequence that identifies the route of administration of contrast agent.
>Include 'Code Sequence Macro' Table 8.8-1		Baseline Context ID is 11.	

>Additional Drug Sequence	(0018,002A)	3	Sequence that identifies any additional drug that is administered with the contrast agent bolus.
>>Include 'Code Sequence Macro' Table 8.8-1		No Baseline Context ID is defined.	
Contrast/Bolus Volume	(0018,1041)	3	Volume injected in milliliters of diluted contrast agent
Contrast/Bolus Start Time	(0018,1042)	3	Time of start of injection
Contrast/Bolus Stop Time	(0018,1043)	3	Time of end of contrast injection
Contrast/Bolus Total Dose	(0018,1044)	3	Total amount in milliliters of the undiluted contrast agent
Contrast Flow Rate(s)	(0018,1046)	3	Rate(s) of injection(s) in milliliters/sec
Contrast Flow Duration(s)	(0018,1047)	3	Duration(s) of injection(s) in seconds. Each Contrast Flow Duration value shall correspond to a value of Contrast Flow Rate (0018,1046).
Contrast/Bolus Ingredient	(0018,1048)	3	Active ingredient of agent. Defined Terms: IODINE GADOLINIUM CARBON DIOXIDE BARIUM
Contrast/Bolus Ingredient Concentration	(0018,1049)	3	Milligrams of active ingredient per milliliter of (diluted) agent

- Note:
1. Flow duration is an alternate method of specifying stop time
 2. Flow rate allows for stepped injections by being capable of multiple values (1,N) instances.
 3. For a 100 ml injection of 76% Diatrizoate and meglumine/sodium, diluted 1:1,
 - the Contrast/Bolus Agent would be "76% Diatrizoate" as text
 - the Contrast/Bolus Volume would be 100 ml,
 - the Contrast/Bolus Total Dose would be 50 ml,
 - the Contrast/Bolus Ingredient would be "IODINE",
 - the Contrast/Bolus Ingredient Concentration would be 370mg/ml.

C.7.6.5 Cine Module

Table C.7-13 specifies the Attributes of a Multi-frame Cine Image.

**Table C.7-13
CINE MODULE ATTRIBUTES**

Attribute Name	Tag	Type	Attribute Description
Preferred Playback Sequencing	(0018,1244)	3	Describes the preferred playback sequencing for a multi-frame image. Enumerated Values: 0 = Looping (1,2...n,1,2,...n,1,2,...n,...) 1 = Sweeping (1,2,...n,n-1,...2,1,2,...n,...)

Frame Time	(0018,1063)	1C	Nominal time (in msec) per individual frame. See C.7.6.5.1.1 for further explanation. Required if Frame Increment Pointer (0028,0009) points to Frame Time.
Frame Time Vector	(0018,1065)	1C	An array which contains the real time increments (in msec) between frames for a Multi-frame image. See C.7.6.5.1.2 for further explanation. Required if Frame Increment Pointer (0028,0009) points to Frame Time Vector.
Start Trim	(0008,2142)	3	The frame number of the first frame of the Multi-frame image to be displayed.
Stop Trim	(0008,2143)	3	The Frame Number of the last frame of a Multi-frame image to be displayed.
Recommended Display Frame Rate	(0008,2144)	3	Recommended rate at which the frames of a Multi-frame image should be displayed in frames/second.
Cine Rate	(0018,0040)	3	Number of frames per second.
Frame Delay	(0018,1066)	3	Time (in msec) from Content Time (0008,0033) to the start of the first frame in a Multi-frame image.
Image Trigger Delay	(0018,1067)	3	Delay time in milliseconds from trigger (e.g., X-ray on pulse) to the first frame of a Multi-frame image.
Effective Duration	(0018,0072)	3	Total time in seconds that data was actually taken for the entire Multi-frame image.
Actual Frame Duration	(0018,1242)	3	Elapsed time of data acquisition in msec per each frame.

C.7.6.5.1 Cine Attribute Descriptions

C.7.6.5.1.1 Frame Time

Frame Time (0018,1063) is the nominal time (in milliseconds) between individual frames of a Multi-frame image. If the Frame Increment Pointer points to this Attribute, Frame Time shall be used in the following manner to calculate 'the relative time' for each frame:

$$\text{Frame 'Relative Time' (n)} = \text{Frame Delay} + \text{Frame Time} * (n-1)$$

where: n = number of frame within the Multi-frame image and the first frame number is one

C.7.6.5.1.2 Frame Time Vector

Frame Time Vector (0018,1065) is an array which contains the time increments (in milliseconds) between the nth frame and the previous frame for a Multi-frame image. The first frame always has a time increment of 0. If the Frame Increment Pointer points to this Attribute, the Frame Time Vector shall be used in the following manner to calculate 'relative time' $T(n)$ for frame n :

$$T(n) = \sum_{i=1}^n \Delta t_i$$

where Δt_i is the i th Frame Time Vector component.

C.7.6.6 Multi-Frame Module

Table C.7-14 specifies the Attributes of a Multi-frame pixel data Image.

Table C.7-14
MULTI-FRAME MODULE ATTRIBUTES

Attribute Name	Tag	Type	Attribute Description
Number of Frames	(0028,0008)	1	Number of frames in a Multi-frame Image. See C.7.6.6.1.1 for further explanation.
Frame Increment Pointer	(0028,0009)	1	Contains the Data Element Tag of the attribute which is used as the frame increment in Multi-frame pixel data. See C.7.6.6.1.1 for further explanation.

C.7.6.6.1 Multi-Frame Attribute Descriptions

C.7.6.6.1.1 Number Of Frames And Frame Increment Pointer

A Multi-frame Image is defined as a Image whose pixel data consists of a sequential set of individual Image Pixel frames. A Multi-frame Image is transmitted as a single contiguous stream of pixels. Frame headers do not exist within the data stream.

Each individual frame shall be defined (and thus can be identified) by the Attributes in the Image Pixel Module (see C.7.6.3). All Image IE Attributes shall be related to the first frame in the Multi-frame image.

The total number of frames contained within a Multi-frame Image is conveyed in the Number of Frames (0028,0008).

The frames within a Multi-frame Image shall be conveyed as a logical sequence. The information which determines the sequential order of the frames shall be identified by the Data Element Tag or tags conveyed by the Frame Increment Pointer (0028,0009). Each specific Image IOD which supports the Multi-frame Module specializes the Frame Increment Pointer(0028,0009) to identify the Attributes which may be used as sequences.

C.7.6.7 Bi-Plane Sequence Module (Retired)

C.7.6.8 Bi-Plane Image Module (Retired)

C.7.6.9 Frame Pointers Module

Table C.7-15 specifies the attributes of a Frame Pointer Module.

**Table C.7-15
FRAME POINTERS MODULE ATTRIBUTES**

Attribute Name	Tag	Type	Attribute Description
Representative Frame Number	(0028,6010)	3	The frame number selected for use as a pictorial representation (e.g. icon) of the Multi-frame Image
Frame Numbers Of Interest (FOI)	(0028,6020)	3	Frame number(s) selected as frames of interest.
Frame Of Interest Description	(0028,6022)	3	Description of each one of the Frame(s) of Interest selected in (0028,6020). If multiple Frames of Interest are selected and this Attribute is used, it shall contain the same number of values as are in Frame Numbers of Interest (0028,6020).

- Notes:
1. Frame numbers begin at 1.
 2. Frame of Interest Description is intended to indicate such frames as Systolic, Diastolic, Stenotic Artery.

C.7.6.10 Mask Module

Table C.7-16 specifies the Attributes that describe mask operations for a Multi-frame image.

**Table C.7-16
MASK MODULE ATTRIBUTES**

Attribute Name	Tag	Type	Attribute Description
Mask Subtraction Sequence	(0028,6100)	1	Defines a sequence which describes mask subtraction operations for a Multi-frame Image.
>Mask Operation	(0028,6101)	1	Defined Term identifying the type of mask operation to be performed. See C.7.6.10.1 for further explanation.
>Applicable Frame Range	(0028,6102)	3	Each pair of numbers in this multi-valued attribute specify a beginning and ending frame number inclusive of a range where this particular mask operation is valid. Discontinuous ranges are represented by multiple pairs of numbers. Frames in a Multi-frame Image are specified by sequentially increasing number values beginning with 1. If this Attribute is missing in this particular sequence item, then the mask operation is applicable throughout the entire Multi-frame Image, subject to certain limits as described in C.7.6.10.1.1.
>Mask Frame Numbers	(0028,6110)	1C	Specifies the frame numbers of the pixel data used to generate this mask. Frames in a Multi-frame Image are specified by sequentially increasing number values beginning with 1. Required if the Mask Operation (0028,6101) is AVG_SUB.
>Contrast Frame Averaging	(0028,6112)	3	Specifies the number of contrast frames to average together before performing the mask operation. If the Attribute is missing, no averaging is performed.
>Mask Sub-pixel Shift	(0028,6114)	3	A pair of floating point numbers specifying the fractional vertical [adjacent row spacing] and horizontal [adjacent column spacing] pixel shift applied to the mask before subtracting it from the contrast frame. See Section C.7.6.10.1.2.
>TID Offset	(0028,6120)	2C	Specifies the offset to be subtracted from the current frame number in order to locate the mask frame in TID mode. If zero length, TID Offset defaults to 1. Required if Mask Operation (0028,6101) is TID.

>Mask Operation Explanation	(0028,6190)	3	Free form explanation of this particular mask operation.
Recommended Viewing Mode	(0028,1090)	2	<p>Specifies the recommended viewing protocol(s).</p> <p>Defined terms:</p> <p>SUB = for subtraction with mask images;</p> <p>NAT = native viewing of image as sent.</p> <p>Note: If an implementation does not recognize the defined term for Recommended Viewing Mode (0028,1090) , reverting to native display mode is recommended.</p>

Note: Frame numbers begin at 1.

C.7.6.10.1 Mask Subtraction Attribute Descriptions

C.7.6.10.1.1 Mask Operation

Mask Operation (0028,6101) specifies a type of mask operation to be performed. The Defined Terms identifying the mask operation to be performed are as follows:

NONE (No Subtraction) No mask subtraction operation is specified;

AVG_SUB (Average Subtraction) The frames specified by the Mask Frame Numbers (0028,6110) are averaged together, shifted by the amount specified in the Mask Sub-pixel Shift (0028,6114), then subtracted from the contrast frames in the range specified in the Applicable Frame Range (0028,6102) . Contrast Frame Averaging (0028,6112) number of frames starting with the current frame are averaged together before the subtraction. If the Applicable Frame Range is not present in this sequence item, the Applicable Frame Range is assumed to end at the last frame number of the image minus Contrast Frame Averaging (0028,6112) plus one;

TID (Time Interval Differencing) The mask for each frame within the Applicable Frame Range (0028,6102) is selected by subtracting TID Offset (0028,6120) from the respective frame number. If the Applicable Frame Range is not present in this sequence item, the Applicable Frame Range is assumed to be a range where TID offset subtracted from any frame number with the range results in a valid frame number within the Multi-frame image.

C.7.6.10.1.2 Mask Sub-pixel Shift

A pair of floating point numbers specifying the fractional vertical [adjacent row spacing] and horizontal [adjacent column spacing] pixel shift applied to the mask before subtracting it from the contrast frame. The row offset results in a shift of the pixels along the column axis. The column offset results in a shift of the pixels along the row axis. A positive row offset is a shift toward the pixels of the lower row of the pixel plane. A positive column offset is a shift toward the pixels of the left hand side column of the pixel plane.

C.7.6.11 Display Shutter Module

The Display shutter is a geometric mask which may be applied on the image for presentation purposes in order to neutralize the display of any of the pixels located outside of the shutter shape.

Geometry of the shutter is specified with respect to a row and column coordinate system where the origin is the upper left hand pixel. This origin is specified by the values 1,1 for row/column. A row coordinate represents a row spacing (vertical) and a column coordinate represents a column spacing (horizontal). Up to three different shutter shapes may be used and superimposed.

The manner in which the display area is neutralized (black-out, gray, or other means) is defined by the Attribute Shutter Presentation Value (0018,1622), or undefined if this Attribute is absent or empty.

Table C.7-17
DISPLAY SHUTTER MODULE

Attribute Name	Tag	Type	Attribute Description
Shutter Shape	(0018,1600)	1	Shape(s) of the shutter defined for display. Enumerated Values: RECTANGULAR CIRCULAR POLYGONAL This multi-valued Attribute shall contain at most one of each Enumerated Value.
Shutter Left Vertical Edge	(0018,1602)	1C	Required if Shutter Shape (0018,1600) is RECTANGULAR. Location of the left edge of the rectangular shutter with respect to pixels in the image given as column.
Shutter Right Vertical Edge	(0018,1604)	1C	Required if Shutter Shape (0018,1600) is RECTANGULAR. Location of the right edge of the rectangular shutter with respect to pixels in the image given as column.
Shutter Upper Horizontal Edge	(0018,1606)	1C	Required if Shutter Shape (0018,1600) is RECTANGULAR. Location of the upper edge of the rectangular shutter with respect to pixels in the image given as row.
Shutter Lower Horizontal Edge	(0018,1608)	1C	Required if Shutter Shape (0018,1600) is RECTANGULAR. Location of the lower edge of the rectangular shutter with respect to pixels in the image given as row.
Center of Circular Shutter	(0018,1610)	1C	Required if Shutter Shape (0018,1600) is CIRCULAR. Location of the center of the circular shutter with respect to pixels in the image given as row and column.
Radius of Circular Shutter	(0018,1612)	1C	Required if Shutter Shape (0018,1600) is CIRCULAR. Radius of the circular shutter with respect to pixels in the image given as a number of pixels along the row direction.

Vertices of the Polygonal Shutter	(0018,1620)	1C	<p>Required if Shutter Shape (0018,1600) is POLYGONAL.</p> <p>Multiple Values where the first set of two values are:</p> <p style="padding-left: 40px;">row of the origin vertex column of the origin vertex</p> <p>Two or more pairs of values follow and are the row and column coordinates of the other vertices of the polygon shutter. Polygon shutters are implicitly closed from the last vertex to the origin vertex and all edges shall be non-intersecting except at the vertices.</p>
Shutter Presentation Value	(0018,1622)	3	<p>The value used to replace those parts of the image occluded by the shutter, in P-Values, from a minimum of 0000H (black) up to a maximum of FFFFH (white).</p> <p>Note: The maximum P-Value for this Attribute may be different from the maximum P-Value from the output of the Presentation LUT, which may be less than 16 bits in depth.</p>

The following figures illustrate the values of coordinate attributes for 1:1 aspect and 2:1 aspect ratio images with rectangular and circular display shutters applied.

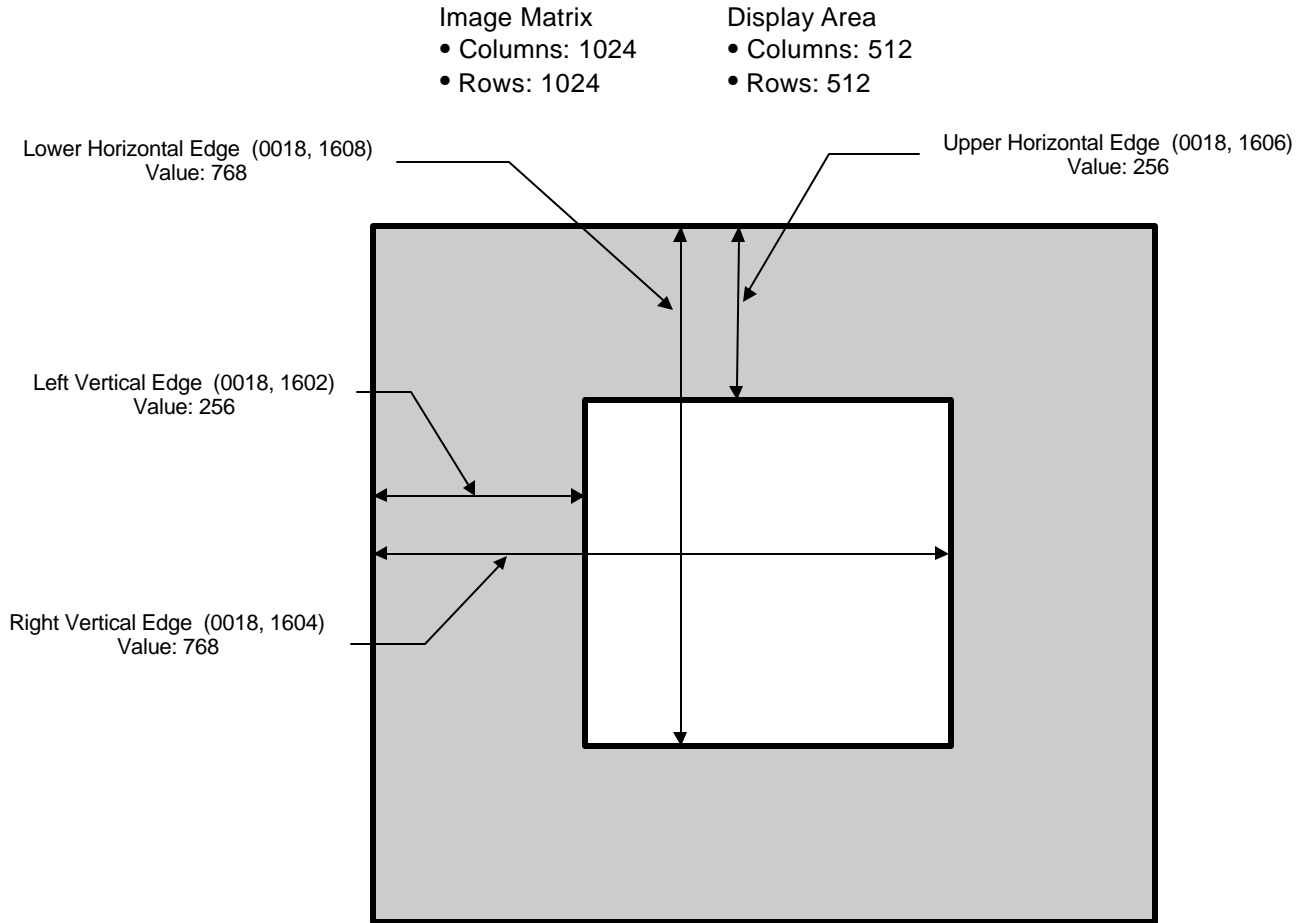

Figure C.7-1
Rectangular Display Shutter
(1:1 aspect ratio image)

Image Matrix
• Columns: 1024
• Rows: 512

Display Area
• Columns: 512
• Rows: 256

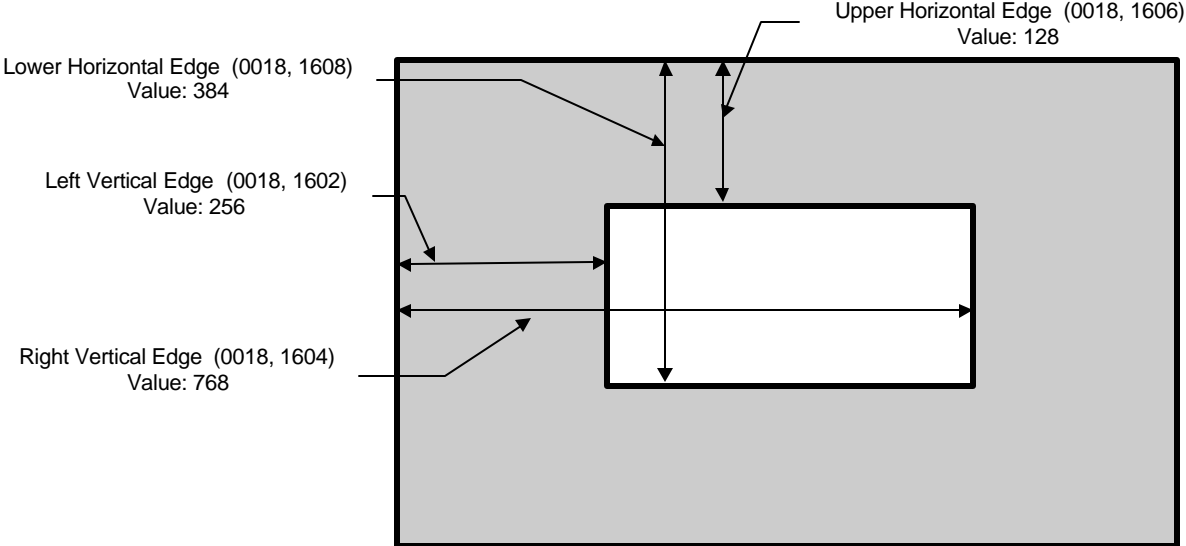

Figure C.7-2
Rectangular Display Shutter
(2:1 aspect ratio images as they would appear before interpolation for display)

Image Matrix
• Columns: 1024
• Rows: 1024

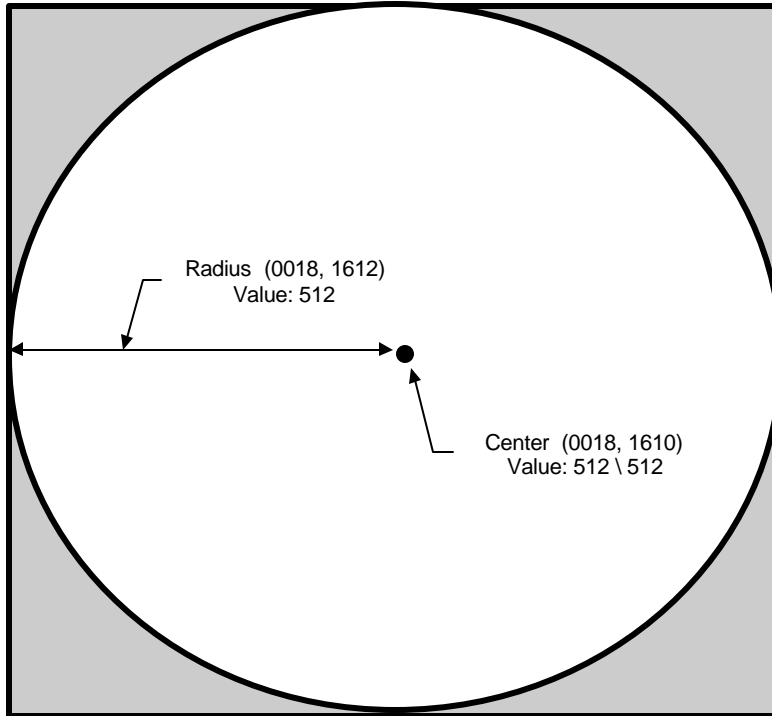

Figure C.7-3
Circular Display Shutter
(1:1 aspect ratio image)

Image Matrix

- Columns: 1024
- Rows: 512

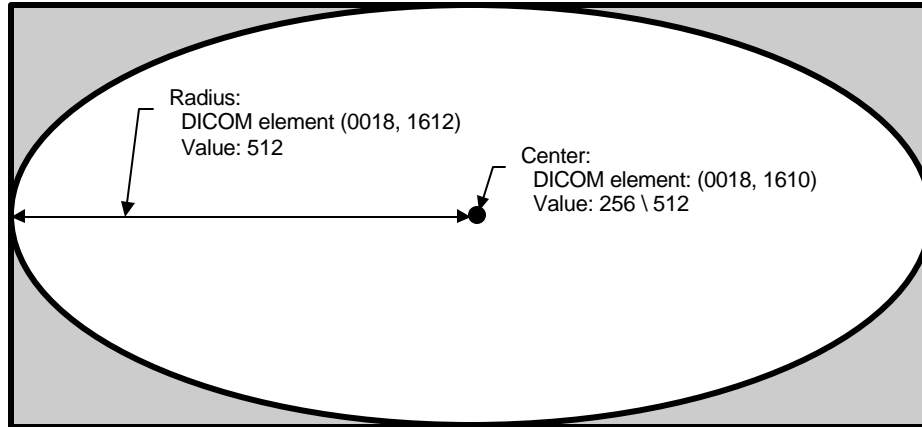

Figure C.7-4
Circular Display Shutter
(2:1 aspect ratio images as they would appear before interpolation for display)

C.7.6.12 Device

Table C.7-18 describes the Attributes of devices (e.g., catheters, markers, baskets) which are associated with a study and/or image.

Table C.7-18
DEVICE MODULE ATTRIBUTES

Attribute Name	Tag	Type	Attribute Description
Device Sequence	(0050,0010)	3	Introduces sequence of items describing devices used which may be visible in the image
>Include 'Code Sequence Macro' Table 8.8-1		Baseline Context ID is 8.	
>Device Length	(0050,0014)	3	Length in mm of device. Required as per Table in Section C.7.6.12.1.1. May be present only if Device Sequence (0050,0010) is present.
>Device Diameter	(0050,0016)	3	Unit diameter of device. Required as per Table in Section C.7.6.12.1.1. May be present only if Device Sequence (0050,0010) is present.

>Device Diameter units	(0050,0017)	2C	Required if Device Diameter (0050,0016) is present. Defined terms: FR = French GA = Gauge IN = Inch MM = Millimeter May be present only if Device Sequence (0050,0010) is present.
>Device Volume	(0050,0018)	3	Volume of device in ml. Required as per Table in Section C.7.6.12.1.1. May be present only if Device Sequence (0050,0010) is present.
>Inter-Marker Distance	(0050,0019)	3	Distance in mm between markers on calibrated device. Required as per Table in Section C.7.6.12.1.1. May be present only if Device Sequence (0050,0010) is present.
>Device Description	(0050,0020)	3	Further description in free form text describing the device. May be present only if Device Sequence (0050,0010) is present.

C.7.6.12.1 Device Attribute Descriptions

C.7.6.12.1.1 Device Type and Size

Depending on the type of device specified by the Code Value (0008,0100) in an item of the Device Sequence (0050,0010), various device size attributes (e.g., Device Length (0050,0014), Device Diameter (0050,0016), Device Volume (0050,0018), Inter Marker Distance (0050,0019)) may be required to fully characterize the device.

C.7.6.13 Therapy

Table C.7-19 describes the Attributes of therapies (e.g. interventions during an angiographic procedure) which are associated with a study and/or image.

**Table C.7-19
THERAPY MODULE ATTRIBUTES**

Attribute Name	Tag	Type	Attribute Description
Interventional Therapy Sequence	(0018,0036)	3	Introduces sequence of items describing interventional therapies
>Include 'Code Sequence Macro' Table 8.8-1		Baseline Context ID is 9.	
>Interventional Status	(0018,0038)	2	Temporal relation to therapeutic intervention Specialized as Enumerated Values: PRE INTERMEDIATE POST NONE Required if Interventional Therapy Sequence (0018,0036) is present.

>Interventional Drug Sequence	(0018,0029)	3	Sequence that identifies the interventional drug. May be present if Interventional Therapy Sequence (0018,0036) is present.
>>Include 'Code Sequence Macro' Table 8.8-1		<i>Baseline Context ID is 10.</i>	
>Intervention Drug Start Time	(0018,0035)	3	Time of administration of the interventional drug. May be present if Interventional Therapy Sequence (0018,0036) is present.
>Intervention Drug Stop Time	(0018,0027)	3	Time of completion of administration of the intervention drug.
> Administration Route Code Sequence	(0054,0302)	3	Sequence that identifies the Administration Route. This sequence shall contain exactly one item.
>>Include 'Code Sequence Macro' Table 8.8-1		<i>Baseline Context ID is 11.</i>	
>Therapy Description	(0018,0039)	3	Further description in free form text describing the therapy. May be present if Interventional Therapy Sequence (0018,0036) is present.

C.7.6.14 Acquisition Context Module

Table C.7.6.14-1 specifies Attributes for description of the conditions present during data acquisition.

This Module shall not contain descriptions of conditions that replace those that are already described in specific Modules or Attributes that are also contained within the IOD that contains this Module.

- Notes:
1. Each item of the Acquisition Context Sequence (0040,0555) contains one item of the Concept-name Code Sequence (0040,A043) and one of the mutually-exclusive Observation-value Attributes: Concept Code Sequence (0040,A168), the pair of Numeric Value (0040,A30A) and Measurement Units Code Sequence (0040,08EA), Date (0040,A121), Time (0040,A122), Person Name (0040,A123) or Text Value (0040,A160).
 2. Acquisition Context includes concepts such as: "pre-contrast", "inspiration", "valgus stress", "post-void", and date and time of contrast administration.
 3. If this SOP Instance is a Multi-frame SOP Instance, each item of the Acquisition Context Sequence (0040,0555) may be configured to describe one frame, all frames, or any specifically enumerated subset set of frames of the Multi-frame SOP Instance.

Table C.7.6.14-1 - ACQUISITION CONTEXT MODULE ATTRIBUTES

Attribute Name	Tag	Type	Attribute Description
Acquisition Context Sequence	(0040,0555)	2	A sequence of repeating items that describes the conditions present during the acquisition of an Image. Zero or more items may be included in this sequence.
>Concept-name Code Sequence	(0040,A043)	1C	A concept that constrains the meaning of (i.e. defines the role of) the Observation Value. The "Name" component of a Name/Value pair. This sequence shall contain exactly one item. Required if a sequence item is present.
<i>>>Include 'Code Sequence Macro' Table 8.8-1</i>			No Baseline Context is defined.
>Referenced Frame Numbers	(0040,A136)	1C	References one or more frames in a Multi-frame SOP Instance. The first frame shall be denoted as frame number one. Required if Acquisition Context Sequence (0040,0555) is sent and this SOP Instance is a Multi-frame SOP Instance and the values in this sequence item do not apply to all frames.
>Numeric Value	(0040,A30A)	1C	This is the Value component of a Name/Value pair when the Concept implied by Concept-name Code Sequence (0040,A043) is a set of one or more numeric values. Required if Concept-name Code Sequence (0040,A043) is present and the value it requires (implies) is a set of one or more integers or real numbers. Shall not be present otherwise.
>Measurement Units Code Sequence	(0040,08EA)	1C	Units of measurement. Only a single Item shall be permitted in this Sequence. Required if a sequence item is present and Numeric Value (0040,A30A) is sent. Shall not be present otherwise.
<i>>>Include 'Code Sequence Macro' Table 8.8-1</i>			Baseline Context ID is 82.
>Date	(0040,A121)	1C	This is the Value component of a Name/Value pair when the Concept implied by Concept-name Code Sequence (0040,A043) is a date. Note: The purpose or role of the date value could be specified in Concept-name Code Sequence (0040,A043). Required if Concept-name Code Sequence (0040,A043) is present and the value it requires (implies) is a date. Shall not be present otherwise.

>Time	(0040,A122)	1C	<p>This is the Value component of a Name/Value pair when the Concept implied by Concept-name Code Sequence (0040,A043) is a time.</p> <p>Note: The purpose or role of the time value could be specified in Concept-name Code Sequence (0040,A043).</p> <p>Required if Concept-name Code Sequence (0040,A043) is present and the value it requires (implies) is a time. Shall not be present otherwise.</p>
>Person Name	(0040,A123)	1C	<p>This is the Value component of a Name/Value pair when the Concept implied by Concept-name Code Sequence (0040,A043) is a Person Name.</p> <p>Note: The role of the person could be specified in Concept-name Code Sequence (0040,A043).</p> <p>Required if Concept-name Code Sequence (0040,A043) is present and the value it requires (implies) is a person name. Shall not be present otherwise.</p>
>Text Value	(0040,A160)	1C	<p>This is the Value component of a Name/Value pair when the Concept implied by Concept-name Code Sequence (0040,A043) is a Text Observation Value.</p> <p>Required if Date (0040,A121), Time (0040,A122), and Person Name (0040,A123) do not fully describe the concept specified by Concept Name Code Sequence (0040,A043). Shall not be present otherwise.</p>
>Concept Code Sequence	(0040,A168)	1C	<p>This is the Value component of a Name/Value pair when the Concept implied by Concept-name Code Sequence (0040,A043) is a Coded Value. This sequence shall contain exactly one item.</p> <p>Required if a sequence item is present and Date (0040,A121), Time (0040,A122), Person Name (0040,A123), Text Value (0040,A160), and the pair of Numeric Value (0040,A30A) and Measurement Units Code Sequence (0040,08EA) are not present.</p>
>>Include 'Code Sequence Macro' Table 8.8-1			No Baseline Context is defined.
Acquisition Context Description	(0040,0556)	3	Free-text description of the image-acquisition context.

C.7.6.15 Bitmap Display Shutter Module

The Bitmap Display Shutter is a bitmap that defines an arbitrary shape which may be applied on the image for presentation purposes in order to neutralize the display of any of the pixels defined in the bitmap.

The manner in which the display area is neutralized (black-out, gray, or other means) is defined by the Attribute Shutter Presentation Value (0018,1622).

The bitmap is specified as a reference to an instance of the Overlay Plane Module C.9.2. The referenced Overlay is specialized such that:

- Overlay Type (60xx,0040) shall be "G",
- Overlay Bits Allocated (60xx,0100) shall be 1,
- Overlay Bit Position (60xx,0102) shall be 0 and
- Overlay Origin (60xx,0050) shall be 1\1.

Overlay Rows (60xx,0010) and Overlay Columns (60xx,0011) shall be the same as Rows (0028,0010) and Columns (0028,0011) in the image respectively.

A value of 1 in the Overlay Data (60xx,3000) shall indicate a pixel to which the shutter is applied, i.e. replaced with Shutter Presentation Value (0018,1622).

The Overlay specified in this Attribute shall not be activated (used as a conventional overlay) by the Overlay/Curve Activation Module C.11.7.

**Table C.7.6.15-1
BITMAP DISPLAY SHUTTER MODULE ATTRIBUTES**

Attribute Name	Tag	Type	Attribute Description
Shutter Shape	(0018,1600)	1	Shape of the shutter defined for display. Enumerated Values are: BITMAP This Attribute shall contain one Value.
Shutter Overlay Group	(0018,1623)	1	Specifies the Group (60xx) of an Overlay stored within the Presentation State IOD that contains the bitmap data, as defined in the Overlay Plane Module C.9.2.
Shutter Presentation Value	(0018,1622)	1	The value used to replace those parts of the image occluded by the shutter, in P-Values, from a minimum of 0000H (black)_up to a maximum of FFFFH (white). Note: The maximum P-Value for this Attribute may be different from the maximum P-Value from the output of the Presentation LUT, which may be less than 16 bits in depth.

C.7.7 Patient Summary Module

Table C.7-20 defines Attributes that provide summary information about the Patient.

Table C.7-20
PATIENT SUMMARY MODULE ATTRIBUTES

Attribute Name	Tag	Type	Attribute Description
Patient's Name	(0010,0010)	2	Patient's full name.
Patient ID	(0010,0020)	2	Primary hospital identification number or code for the patient.

C.7.8 Study Content Module

Table C.7-21 defines Attributes that provide study content information.

Table C.7-21
STUDY CONTENT MODULE ATTRIBUTES

Attribute Name	Tag	Type	Attribute Description
Study ID	(0020,0010)	2	User or equipment generated Study identifier
Study Instance UID	(0020,000D)	1	Unique identifier for the Study
Referenced Series Sequence	(0008,1115)	1	Sequence of Repeating Items where each Item includes the Attributes of a Series. Zero or more Items may be included in this Sequence.
>Series Instance UID	(0020,000E)	1	Unique identifier of the Series.
>Retrieve AE Title	(0008,0054)	2C	Title of the DICOM Application Entity where the Image(s) may be retrieved on the network. This Attribute shall be present only if the Images may be retrieved at the SERIES level using a media storage. See PS 3.4.
>Storage Media File-Set ID	(0088,0130)	2C	The user or implementation specific human readable identifier that identifies the Storage Media on which the Image(s) reside. This Attribute shall be present only if the Image(s) may be retrieved at the SERIES level using a media storage.
>Storage Media File-Set UID	(0088,0140)	2C	Uniquely identifies the Storage Media on which the Image(s) reside. This Attribute shall be present only if the Image(s) may be retrieved at the SERIES level using a media storage.
>Referenced Image Sequence	(0008,1140)	1	Sequence of Repeating Items where each Item provides reference to a set of Image SOP Class/SOP Instance pairs that are contained in the Series identified by the Series Instance UID (0020,000E).

>>Referenced SOP Class UID	(0008,1150)	2	Uniquely identifies the referenced SOP Class. This Attribute is used only if Images may be retrieved as Single Image SOP Classes.
>>Reference SOP Instance UID	(0008,1155)	2	Uniquely identifies the referenced SOP Instance. This Attribute is used only if Images may be retrieved as Single Image SOP Classes.
>>Retrieve AE	(0008,0054)	2C	Title of the DICOM Application Entity where the Image(s) may be retrieved on the network. This Attribute shall be present only if not present in the Referenced Series Sequence (0008,1115) if the Images may be retrieved at the IMAGE Query/Retrieve Level. See PS 3.4.
>>Storage Media File-Set ID	(0088,0130)	2C	The user or implementation specific human readable identifier that identifies the Storage Media on which the Image(s) reside. This Attribute shall be present only if not present in the Series Sequence (0008,1115) and if the Image(s) may be retrieved at the IMAGE level using a media storage.
>>Storage Media File-Set UID	(0088,0140)	2C	Uniquely identifies the Storage Media on which the Image(s) reside. This Attribute shall be present only if not present in the Referenced Series Sequence (0008,1115) and if the Image(s) may be retrieved at the IMAGE level using a media storage.

C.7.9 Palette Color Lookup Table Module

Table C.7-22 specifies the Attributes that describe the Lookup table data for images with Palette Color photometric interpretation.

When the Palette Color Lookup Table Module is present, the conditional requirements for the use of Palette Color Lookup Table Data (0028,1201-1203) and Segmented Palette Color Lookup Table Data (0028,1221-1223), described in Table C.7.9, shall take precedence over the conditional requirements described in the Image Pixel Module (See Section C.7.6.3).

Table C.7-22
PALETTE COLOR LOOKUP MODULE

Attribute Name	Tag	Type	Attribute Description
Red Palette Color Lookup Table Descriptor	(0028,1101)	1C	Specifies the format of the Red Palette Color Lookup Table Data (0028,1201). Required if Photometric Interpretation (0028,0004) has a value of PALETTE COLOR or ARGB. See C.7.6.3.1.5 for further explanation.

Green Palette Color Lookup Table Descriptor	(0028,1102)	1C	Specifies the format of the Green Palette Color Lookup Table Data (0028,1202). Required if Photometric Interpretation (0028,0004) has a value of PALETTE COLOR or ARGB. See C.7.6.3.1.5 for further explanation.
Blue Palette Color Lookup Table Descriptor	(0028,1103)	1C	Specifies the format of the Blue Palette Color Lookup table Data (0028,1203). Required if Photometric Interpretation (0028,0004) has a value of PALETTE COLOR or ARGB. See C.7.6.3.1.5 for further explanation.
Palette Color Lookup Table UID	(0028,1199)	3	Palette Color Lookup Table UID. See C.7.9.1 for further explanation.
Red Palette Color Lookup Table Data	(0028,1201)	1C	Red Palette Color Lookup Table Data. Required if Photometric Interpretation (0028,0004) has a value of PALETTE COLOR or ARGB and segmented data is NOT used. See C.7.6.3.1.6 for further explanation.
Green Palette Color Lookup Table Data	(0028,1202)	1C	Green Palette Color Lookup Table Data. Required if Photometric Interpretation (0028,0004) has a value of PALETTE COLOR or ARGB and segmented data is NOT used. See C.7.6.3.1.6 for further explanation.
Blue Palette Color Lookup Table Data	(0028,1203)	1C	Blue Palette Color Lookup Table Data. Required if Photometric Interpretation (0028,0004) has a value of PALETTE COLOR or ARGB and segmented data is NOT used. See C.7.6.3.1.6 for further explanation.
Segmented Red Palette Color Lookup Table Data	(0028,1221)	1C	Segmented Red Palette Color Lookup Table Data. Required if Photometric Interpretation (0028,0004) has a value of PALETTE COLOR and segmented data is used. See C.7.9.2 for further explanation.
Segmented Green Palette Color Lookup Table Data	(0028,1222)	1C	Segmented Green Palette Color Lookup Table Data. Required if Photometric Interpretation (0028,0004) has a value of PALETTE COLOR and segmented data is used. See C.7.9.2 for further explanation.
Segmented Red Palette Color Lookup Table Data	(0028,1223)	1C	Segmented Blue Palette Color Lookup Table Data. Required if Photometric Interpretation (0028,0004) has a value of PALETTE COLOR and segmented data is used. See C.7.9.2 for further explanation.

C.7.9.1 Palette Color Lookup Table UID

This data element uniquely identifies a palette color lookup table set (red, green, blue).

Note: This can be used to avoid reloading a palette if a system already has that palette loaded without examining all the data entries in the palette.

C.7.9.2 Segmented Palette Color Lookup Table Data

The Segmented Palette Color Lookup Table Data (0028,1221-1223) is stored as a series of segments, see Table C.7-23. When the segments are expanded into the actual lookup table data, it shall have the number of table entries specified by the first value of the Palette Color Lookup Table Descriptors (0028,1101-1103), Number of Table Entries.

These lookup tables shall be used only when segmented lookup table data use is desirable and there is a single sample per pixel (single image plane) in the image.

Table C.7-23
COMPRESSED PALETTE COLOR LOOKUP TABLE DATA

Segment 0
Segment 1
...
Segment n

There are currently three types of segments: discrete, linear, and indirect. The segments type is identified by the opcodes in Table C.7-24:

Table C.7-24
SEGMENT TYPES

Opcode	Segment type
0	Discrete
1	Linear
2	Indirect
3 & above	reserved

C.7.9.2.1 Discrete Segment Type

The discrete segment is used to represent a series of palette components which are not monotonic with respect to their predecessors or successors. The SegmentLength indicates the number of lookup table entries.

The format of the Discrete Segment Type shall be as in Table C.7-25:

Table C.7-25
DISCRETE SEGMENT TYPE

Segment Opcode = 0
Segment Length
Segment Length number of lookup table entries

C.7.9.2.2 Linear Segment Type

The linear segment represents a series of palette components whose values may be represented by a straight line.

X = palette address, Y = Value contained in the palette.

(X_0, Y_0) = end of the previous segment

$(X_0 + \text{SegmentLength}, Y_1)$ = end of this linear segment

Where: Y_1 is contained in the data portion of this segment.

During expansion, the application should “connect” the previous segment’s endpoint, (X_0, Y_0) , with this segment’s endpoint, $(X_0 + \text{SegmentLength}, Y_1)$ using a straight line, by computing the values for each point between the endpoints.

Note: Because the linear segment uses the end point from the previous segment, a linear segment can not be the first segment.

The linear segment’s format shall be as as in Table C.7-26:

**Table C.7-26
LINEAR SEGMENT TYPE**

Segment Opcode = 1
SegmentLength
Y1

C.7.9.2.3 Indirect Segment Type

The indirect segment allows the re-use of repetitive regions within lookup table without respecifying the segment. The opcode is followed by the number of segments to copy and one offset pointer to the first segment to copy. The byte offset is relative to the beginning of the lookup table. For example, if an indirect segment wants to point to the first segment, then the offset will be zero. The offset is a 32 bit value but is stored in the segment as a least significant 16 bit value followed by a most significant 16 bit value. An indirect segment shall not point to or copy another indirect segment. This avoids the need for recursion and also avoids the possibility of infinite loops.

The indirect segment’s format shall be as follows:

**Table C.7-27
INDIRECT SEGMENT TYPE**

Segment Opcode = 2
Number of segments to copy
Least significant 16 bits of byte offset to first segment to copy
Most significant 16 bits of byte offset to first segment to copy

C.8 MODALITY SPECIFIC MODULES

C.8.1 Computed Radiography Modules

This Section describes Computed Radiography Series and Image Modules. These Modules contain Attributes that are specific to Computed Radiography images. There is no Computed Radiography Equipment Module.

C.8.1.1 CR Series Module

Table C.8-1 contains IOD Attributes that describe a computed radiography series performed on the patient.

**Table C.8-1
CR SERIES MODULE ATTRIBUTES**

Attribute Name	Tag	Type	Attribute Description
Body Part Examined	(0018,0015)	2	Text description of the part of the body examined. Defined Terms: SKULL CSPINE TSPINE LSPINE SSPINE COCCYX CHEST CLAVICLE BREAST ABDOMEN PELVIS HIP SHOULDER ELBOW KNEE ANKLE HAND FOOT EXTREMITY.
View Position	(0018,5101)	2	Radiographic view associated with Patient Position (0018,5100). Defined Terms: AP = Anterior/Posterior PA = Posterior/Anterior LL = Left Lateral RL = Right Lateral RLD = Right Lateral Decubitus LLD = Left Lateral Decubitus RLO = Right Lateral Oblique LLO = Left Lateral Oblique
Filter Type	(0018,1160)	3	Label for the type of filter inserted into the x-ray beam
Collimator/grid Name	(0018,1180)	3	Label describing any grid inserted.

Focal Spot	(0018,1190)	3	Size of the focal spot in mm. For devices with variable focal spot or multiple focal spots, small dimension followed by large dimension.
Plate Type	(0018,1260)	3	Label of the type of storage phosphor plates used in this series
Phosphor Type	(0018,1261)	3	Label of type of phosphor on the plates

C.8.1.2 CR Image Module

Table C.8-2 contains IOD Attributes that describe computed radiography images.

Table C.8-2
CR IMAGE MODULE ATTRIBUTES

Attribute Name	Tag	Type	Attribute Description
Photometric Interpretation	(0028,0004)	1	Specifies the intended interpretation of the pixel data. Shall have one of the following Enumerated Values: MONOCHROME1 MONOCHROME2
KVP	(0018,0060)	3	Peak kilo voltage output of the x-ray generator used
Plate ID	(0018,1004)	3	The ID or serial number of the sensing plate upon which the image was acquired
Distance Source to Detector	(0018,1110)	3	Distance in mm from source to detector center
Distance Source to Patient	(0018,1111)	3	Distance in mm from source to isocenter (center of field of view)
Exposure Time	(0018,1150)	3	Time of x-ray exposure in msec
X-ray Tube Current	(0018,1151)	3	X-ray Tube Current in mA.
Exposure	(0018,1152)	3	The exposure expressed in mAs, for example calculated from Exposure Time and X-ray Tube Current.
Exposure in μ As	(0018,1153)	3	The exposure expressed in μ As, for example calculated from Exposure Time and X-ray Tube Current.
Imager Pixel Spacing	(0018,1164)	3	Physical distance measured at the front plane of the Image Receptor housing between the center of each pixel. Specified by a numeric pair - row spacing value (delimiter) column spacing value - in mm. In the case of CR, the front plane is defined to be the external surface of the CR plate closest to the patient and radiation source.
Generator Power	(0018,1170)	3	Power in kW to the x-ray generator.

Acquisition Device Processing Description	(0018,1400)	3	Describes device-specific processing associated with the image (e.g. Organ Description)
Acquisition Device Processing Code	(0018,1401)	3	Code representing the device-specific processing associated with the image (e.g. CR Organ Filtering code)
Cassette Orientation	(0018,1402)	3	Orientation of cassette, used to properly position the image for display. Enumerated Values: LANDSCAPE PORTRAIT
Cassette Size	(0018,1403)	3	Size of cassette. Defined Terms: 18CMX24CM 8INX10IN 24CMX30CM 10INX12IN 30CMX35CM 30CMX40CM 11INX14IN 35CMX35CM 14INX14IN 35CMX43CM 14INX17IN
Exposures on Plate	(0018,1404)	3	Total number of x-ray exposures that have been made on the plate identified in Plate ID (0018,1004)
Relative X-ray Exposure	(0018,1405)	3	Relative x-ray exposure on the plate. Meaning of values is implementation specific. May be used to adjust the dynamic range of the plate digitizer (scanner).
Sensitivity	(0018,6000)	3	Read out sensitivity.

C.8.2 CT Modules

This Section describes the CT Image Module. This Module contains all Attributes that are specific to CT images.

C.8.2.1 CT Image Module

The table in this Section contains IOD Attributes that describe CT images.

Table C.8-3
CT IMAGE MODULE ATTRIBUTES

Attribute Name	Tag	Type	Attribute Description
Image Type	(0008,0008)	1	Image identification characteristics. See C.8.2.1.1.1 for specialization.
Samples per Pixel	(0028,0002)	1	Number of samples (planes) in this image. See C.8.2.1.1.2 for specialization.
Photometric Interpretation	(0028,0004)	1	Specifies the intended interpretation of the pixel data. See C.8.2.1.1.3 for specialization.
Bits Allocated	(0028,0100)	1	Number of bits allocated for each pixel sample. Each sample shall have the same number of bits allocated. See C.8.2.1.1.4 for specialization.
Bits Stored	(0028,0101)	1	Number of bits stored for each pixel sample. Each sample shall have the same number of bits stored. See C.8.2.1.1.5 for specialization.
High Bit	(0028,0102)	1	Most significant bit for pixel sample data. Each sample shall have the same high bit. See C.8.2.1.1.6 for specialization.
Rescale Intercept	(0028, 1052)	1	The value b in relationship between stored values (SV) and Hounsfield (HU). $HU = m \cdot SV + b$
Rescale Slope	(0028,1053)	1	m in the equation specified in Rescale Intercept (0028,1052).
KVP	(0018,0060)	2	Peak kilo voltage output of the x-ray generator used
Acquisition Number	(0020,0012)	2	A number identifying the single continuous gathering of data over a period of time which resulted in this image
Scan Options	(0018,0022)	3	Parameters of scanning sequence.
Data Collection Diameter	(0018,0090)	3	The diameter in mm of the region over which data were collected
Reconstruction Diameter	(0018,1100)	3	Diameter in mm of the region from within which data were used in creating the reconstruction of the image. Data may exist outside this region and portions of the patient may exist outside this region.

Distance Source to Detector	(0018,1110)	3	Distance in mm from source to detector center
Distance Source to Patient	(0018,1111)	3	Distance in mm from source to isocenter (center of field of view)
Gantry/Detector Tilt	(0018,1120)	3	Nominal angle of tilt in degrees of the scanning gantry. Not intended for mathematical computations.
Table Height	(0018,1130)	3	The distance in mm of the top of the patient table to the center of rotation; below the center is positive.
Rotation Direction	(0018,1140)	3	Direction of rotation of the source when relevant, about nearest principal axis of equipment. Enumerated Values: CW = clockwise CC = counter clockwise
Exposure Time	(0018,1150)	3	Time of x-ray exposure in msec
X-ray Tube Current	(0018,1151)	3	X-ray Tube Current in mA.
Exposure	(0018,1152)	3	The exposure expressed in mAs, for example calculated from Exposure Time and X-ray Tube Current.
Exposure in μ As	(0018,1153)	3	The exposure expressed in μ As, for example calculated from Exposure Time and X-ray Tube Current.
Filter Type	(0018,1160)	3	Label for the type of filter inserted into the x-ray beam.
Generator Power	(0018,1170)	3	Power in kW to the x-ray generator.
Focal Spot	(0018,1190)	3	Size of the focal spot in mm. For devices with variable focal spot or multiple focal spots, small dimension followed by large dimension.
Convolution Kernel	(0018,1210)	3	A label describing the convolution kernel or algorithm used to reconstruct the data

C.8.2.1.1 CT Image Attribute Descriptions

C.8.2.1.1.1 Image Type

For CT Images, Image Type (0008,0008) is specified to be Type 1 and uses one of the following Defined Terms for Value 3:

AXIAL identifies a CT Axial Image
LOCALIZER identifies a CT Localizer Image

C.8.2.1.1.2 Samples Per Pixel

For CT Images, Samples per Pixel (0028,0002) shall have an Enumerated Value of 1.

C.8.2.1.1.3 Photometric Interpretation

For CT Images, Photometric Interpretation (0028,0004) shall have one of the following Enumerated Values:

MONOCHROME1
MONOCHROME2

See C.7.6.3.1.1.2 for definition of these terms.

C.8.2.1.1.4 Bits Allocated

For CT Images, Bits Allocated (0028,0100) shall have the Enumerated Value of 16.

C.8.2.1.1.5 Bits Stored

For CT Images, Bits Stored (0028,0101) shall have the Enumerated Values of 12 to 16.

C.8.2.1.1.6 High Bit

For CT Images, High Bit (0028,0102) shall have only the Enumerated Value of one less than the value sent in Bits Stored.

C.8.3 MR Modules

This Section describes the MR Image Module. This Module contains all Attributes that are specific to MR images.

C.8.3.1 MR Image Module

Table C.8-4 contains the Attributes that describe MR images.

**Table C.8-4
MR IMAGE MODULE ATTRIBUTES**

Attribute Name	Tag	Type	Attribute Description
Image Type	(0008,0008)	1	Image identification characteristics. See C.8.3.1.1.1 for specialization.
Samples per Pixel	(0028,0002)	1	Number of samples (planes) in this image. See C.8.3.1.1.2 for specialization.
Photometric Interpretation	(0028,0004)	1	Specifies the intended interpretation of the pixel data. See C.8.3.1.1.3 for specialization.
Bits Allocated	(0028,0100)	1	Number of bits allocated for each pixel sample. Each sample shall have the same number of bits allocated. See C.8.3.1.1.4 for specialization.
Scanning Sequence	(0018,0020)	1	Description of the type of data taken. Enumerated Values: SE = Spin Echo IR = Inversion Recovery GR = Gradient Recalled EP = Echo Planar RM = Research Mode Note: Multi-valued, but not all combinations are valid (e.g. SE/GR, etc.).
Sequence Variant	(0018,0021)	1	Variant of the Scanning Sequence. Defined Terms: SK = segmented k-space MTC = magnetization transfer contrast SS = steady state TRSS = time reversed steady state SP = spoiled MP = MAG prepared OSP = oversampling phase NONE = no sequence variant

Scan Options	(0018,0022)	2	Parameters of scanning sequence. Defined Terms: PER = Phase Encode Reordering RG = Respiratory Gating CG = Cardiac Gating PPG = Peripheral Pulse Gating FC = Flow Compensation PFF = Partial Fourier - Frequency PFP = Partial Fourier - Phase SP = Spatial Presaturation FS = Fat Saturation
MR Acquisition Type	(0018,0023)	2	Identification of data encoding scheme. Enumerated Values: 2D = frequency x phase 3D = frequency x phase x phase
Repetition Time	(0018,0080)	2C	The period of time in msec between the beginning of a pulse sequence and the beginning of the succeeding (essentially identical) pulse sequence. Required except when Scanning Sequence (0018,0020) is EP and Sequence Variant (0018,0021) is not SK.
Echo Time	(0018,0081)	2	Time in ms between the middle of the excitation pulse and the peak of the echo produced (kx=0). In the case of segmented k-space, the TE(eff) is the time between the middle of the excitation pulse to the peak of the echo that is used to cover the center of k-space (i.e. -kx=0, ky=0).
Echo Train Length	(0018,0091)	2	Number of lines in k-space acquired per excitation per image.
Inversion Time	(0018,0082)	2C	Time in msec after the middle of inverting RF pulse to middle of excitation pulse to detect the amount of longitudinal magnetization. Required if Scanning Sequence (0018,0020) has values of IR.
Trigger Time	(0018,1060)	2C	Time, in msec, between peak of the R wave and the peak of the echo produced. In the case of segmented k-space, the TE(eff) is the time between the peak of the echo that is used to cover the center of k-space. Required for Scan Options (0018,0022) which include heart gating (e.g. CG, PPG, etc.)
Sequence Name	(0018,0024)	3	User defined name for the Scanning Sequence (0018,0020) and Sequence Variant (0018,0021) combination.

Angio Flag	(0018,0025)	3	Angio Image Indicator. Primary image for Angio processing. Enumerated Values: Y = Image is Angio N = Image is not Angio
Number of Averages	(0018,0083)	3	Number of times a given pulse sequence is repeated before any parameter is changed
Imaging Frequency	(0018,0084)	3	Precession frequency in MHz of the nucleus being addressed
Imaged Nucleus	(0018,0085)	3	Nucleus that is resonant at the imaging frequency. Examples: 31P, 1H
Echo Number	(0018,0086)	3	The echo number used in generating this image. In the case of segmented k-space, it is the effective Echo Number.
Magnetic Field Strength	(0018,0087)	3	Nominal field strength of MR magnet, in Tesla
Spacing Between Slices	(0018,0088)	3	Spacing between slices, in mm. The spacing is measured from the center-to-center of each slice.
Number of Phase Encoding Steps	(0018,0089)	3	Total number of lines in k-space in the 'y' direction collected during acquisition.
Percent Sampling	(0018,0093)	3	Fraction of acquisition matrix lines acquired, expressed as a percent.
Percent Phase Field of View	(0018,0094)	3	Ratio of field of view dimension in phase direction to field of view dimension in frequency direction, expressed as a percent.
Pixel Bandwidth	(0018,0095)	3	Reciprocal of the total sampling period, in hertz per pixel.
Nominal Interval	(0018,1062)	3	Average R-R interval used for the scans, in msec
Beat Rejection Flag	(0018,1080)	3	Beat length sorting has been applied. Enumerated Values: Y = yes N = No
Low R-R Value	(0018,1081)	3	R-R interval low limit for beat rejection, in msec
High R-R Value	(0018,1082)	3	R-R interval high limit for beat rejection, in msec
Intervals Acquired	(0018,1083)	3	Number of R-R intervals acquired.
Intervals Rejected	(0018,1084)	3	Number of R-R intervals rejected.
PVC Rejection	(0018,1085)	3	Description of type of PVC rejection criteria used.
Skip Beats	(0018,1086)	3	Number of beats skipped after a detected arrhythmia.

Heart Rate	(0018,1088)	3	Beats per minute.
Cardiac Number of Images	(0018,1090)	3	Number of images per cardiac cycle.
Trigger Window	(0018,1094)	3	Percent of R-R interval, based on Heart Rate (0018,1088), prescribed as a window for a valid/usable trigger.
Reconstruction Diameter	(0018,1100)	3	Diameter in mm. of the region from within which data were used in creating the reconstruction of the image. Data may exist outside this region and portions of the patient may exist outside this region.
Receiving Coil	(0018,1250)	3	Received coil used.
Transmitting Coil	(0018,1251)	3	Transmitted coil used.
Acquisition Matrix	(0018,1310)	3	Dimensions of the acquired frequency /phase data before reconstruction. Multi-valued: frequency rows\frequency columns\phase rows\phase columns.
Phase Encoding Direction	(0018,1312)	3	The axis of phase encoding with respect to the image. Enumerated Values: ROW = phase encoded in rows. COL = phase encoded in columns.
Flip Angle	(0018,1314)	3	Steady state angle in degrees to which the magnetic vector is flipped from the magnetic vector of the primary field.
SAR	(0018,1316)	3	Calculated whole body Specific Absorption Rate in watts/kilogram.
Variable Flip Angle Flag	(0018,1315)	3	Flip angle variation applied during image acquisition. Enumerated Values: Y = yes N = no
dB/dt	(0018,1318)	3	The rate of change of the gradient coil magnetic flux density with time (T/s).
Temporal Position Identifier	(0020,0100)	3	Temporal order of a dynamic or functional set of Images.
Number of Temporal Positions	(0020,0105)	3	Total number of temporal positions prescribed.
Temporal Resolution	(0020,0110)	3	Time delta between Images in a dynamic of functional set of Images.

C.8.3.1.1 MR Image Attribute Descriptions

C.8.3.1.1.1 Image Type

For MR Images, Image Type (0008,0008) is specified to be Type 1 and use one of the following Defined Terms for Value 3:

MPR

PROJECTION IMAGE

T1 MAP

T2 MAP	DIFFUSION MAP	DENSITY MAP
PHASE MAP	VELOCITY MAP	IMAGE ADDITION
PHASE SUBTRACT	MODULUS SUBTRACT	OTHER

C.8.3.1.1.2 Samples Per Pixel

For MR Images, Samples per Pixel (0028,0002) shall have an Enumerated Value of 1.

C.8.3.1.1.3 Photometric Interpretation

For MR Images, Photometric Interpretation (0028,0004) shall have one of the following Enumerated Values:

MONOCHROME1
MONOCHROME2

See C.7.6.3.1.2 for definition of these terms.

C.8.3.1.1.4 Bits Allocated

For MR Images, Bits Allocated (0028,0100) shall have the Enumerated Value of 16.

C.8.4 Nuclear Medicine Modules

This Section describes Nuclear Medicine Series, Equipment, and Image Modules. These Modules contain Attributes that are specific to the NM Image IOD.

Note: There are some cases where it may be necessary to use several SOP Instances to encode a single NM acquisition. For example, the matrix size must remain constant within a SOP instance. Multiple matrix sizes require multiple SOP instances. Similarly, multiple gated stress levels require separate SOP instances for each stress level. However, a receiving AE is not expected to recombine them.

C.8.4.1 NM Series Module (Retired)

Section C.8.4.1 was defined in a previous version of the DICOM Standard. The Section is now retired.

C.8.4.2 NM Equipment Module (Retired)

Section C.8.4.2 was defined in a previous version of the DICOM Standard. The Section is now retired.

C.8.4.3 NM Image Module (Retired)

Section C.8.4.3 was defined in a previous version of the DICOM Standard. The Section is now retired.

C.8.4.4 NM SPECT Acquisition Image Module (Retired)

Section C.8.4.4 was defined in a previous version of the DICOM Standard. The Section is now retired.

C.8.4.5 NM Multi-gated Acquisition Image Module (Retired)

Section C.8.4.5 was defined in a previous version of the DICOM Standard. The Section is now retired.

C.8.4.6 NM/PET Patient Orientation Module

Table C.8-5 specifies the Attributes that describe the NM/PET Patient Orientation.

**Table C.8-5
NM/PET PATIENT ORIENTATION MODULE ATTRIBUTES**

Attribute Name	Tag	Type	Attribute Description
Patient Orientation Code Sequence	(0054,0410)	2	Sequence that describes the orientation of the patient with respect to gravity. See C.8.4.6.1.1 for further explanation.
<i>>Include 'Code Sequence Macro' Table 8.8-1</i>			<i>Baseline Context ID is 19. The Coding Scheme Designator (0008,0102) shall have an Enumerated Value of "99SDM" for historical reasons. Code Meaning (0008,0104) shall be Type 3 for historical reasons.</i>
> Patient Orientation Modifier Code Sequence	(0054,0412)	2C	Patient Orientation Modifier. Required if needed to fully specify the orientation of the patient with respect to gravity. See C.8.4.6.1.2 for further explanation.
<i>>>Include 'Code Sequence Macro' Table 8.8-1</i>			<i>Baseline Context ID is 20. The Coding Scheme Designator (0008,0102) shall have an Enumerated Value of "99SDM" for historical reasons. Code Meaning (0008,0104) shall be Type 3 for historical reasons.</i>
Patient Gantry Relationship Code Sequence	(0054,0414)	2	Sequence which describes the orientation of the patient with respect to the gantry. See Section C.8.4.6.1.3 for further explanation.
<i>>Include 'Code Sequence Macro' Table 8.8-1</i>			<i>Baseline Context ID is 21. The Coding Scheme Designator (0008,0102) shall have an Enumerated Value of "99SDM" for historical reasons. Code Meaning (0008,0104) shall be Type 3 for historical reasons.</i>

C.8.4.6.1 NM/PET Patient Orientation Attribute Descriptions

C.8.4.6.1.1 Patient Orientation Code Sequence

The Patient Orientation Code Sequence (0054,0410) is used to describe the orientation of the patient with respect to gravity, and is independent of the position in the gantry. Only a single Item shall be permitted in this sequence.

C.8.4.6.1.2 Patient Orientation Modifier Code Sequence

The Patient Orientation Modifier Code Sequence (0054,0412) is used to modify or enhance the orientation specified by Patient Orientation Code Sequence (0054,0410). Only a single Item shall be permitted in this sequence.

C.8.4.6.1.3 Patient Gantry Relationship Code Sequence

Patient Gantry Relationship Code Sequence (0054,0414) is used to describe the patient direction within the gantry, such as head-first or feet-first. When imaging the extremities, these directions are related to normal anatomic position.

Example: In normal anatomic position, the fingers point towards the feet.

Only a single Item shall be permitted in this sequence.

C.8.4.7 NM Image Pixel Module

Table C.8-6 specifies the Attributes that describe the pixel data of a NM image.

**Table C.8-6
NM IMAGE PIXEL MODULE ATTRIBUTES**

Attribute Name	Tag	Type	Attribute Description
Samples per Pixel	(0028,0002)	1	Number of samples (color planes) in this image. The value shall be 1.
Photometric Interpretation	(0028,0004)	1	Specifies the intended interpretation of the pixel data. See C.8.4.7.1.1 for further explanation.
Bits Allocated	(0028,0100)	1	Number of bits allocated for each pixel sample. Each sample shall have the same number of bits allocated. Enumerated Values: 8, 16.
Bits Stored	(0028,0101)	1	Number of bits stored for each pixel sample. Each sample shall have the same number of bits stored. The value shall be the same as the value in Bits Allocated (0028,0100).
High Bit	(0028,0102)	1	Most significant bit for pixel sample data. Each sample shall have the same high bit. Shall be one less than the value in Bits Stored (0028,0101).
Pixel Spacing	(0028,0030)	2	Physical distance in the patient between the center of each pixel, specified by a numeric pair - adjacent row spacing (delimiter) adjacent column spacing, in mm.

C.8.4.7.1 NM Image Pixel Attribute Descriptions

C.8.4.7.1.1 Photometric Interpretation

For NM Images, Photometric Interpretation (0028,0004) shall have one of the following Enumerated Values:

- MONOCHROME2
- PALETTE COLOR

See C.7.6.3.1.2 for definition of these terms.

C.8.4.8 NM Multi-frame Module

Table C.8-7 specifies the Attributes of a NM Multi-frame Image. This module is always included in a NM SOP instance, even if there is only one frame in the image.

A NM Image object is always a multi-dimensional multi-frame image. The order and organization of the frames within each image is defined by the Frame Increment Pointer (0028,0009). The Frame Increment Pointer (0028,0009) references one or more indexing vectors. An indexing vector is a 1 dimensional array with exactly one element for each frame in the image. The value of the nth element in the indexing vector represents the index for the nth frame, in that dimension. Indices are always numbered starting from 1.

Note: The scheme for encoding a multi-dimensional array of frames into a single image object is as follows. First, the definition of the data element called the Frame Increment Pointer is changed so that it can be multi-valued (i.e. its VM is now 1-n). Each value of the Frame Increment Pointer represents one of the dimensions of the array, with the last value representing the most rapidly changing index.

Each value of the Frame Increment Pointer is the tag of a data element which is an indexing vector. An indexing vector is a 1 dimensional array with exactly one element for each frame in the image. The value of the nth element in the indexing vector represents the index for the nth frame, in that dimension. For example, suppose you are encoding a Dynamic image consisting of 2 phases (containing 5 and 2 frames, respectively), from each of two detectors, using one isotope, which gives a total of 14 frames in the image. For a Dynamic image, the Frame Increment Pointer is defined as:

Frame Increment Pointer = Energy Window Vector (0054,0010) \ Detector Vector (0054,0020) \ Phase Vector (0054,0030) \ Time Slice Vector (0054,0100)

The Pixel Data (7FE0,0010) would contain the frames in the following order:

Frame	1	2	3	4	5	6	7	8	9	10	11	12	13	14
Energy Window #	1	1	1	1	1	1	1	1	1	1	1	1	1	1
Detector #	1	1	1	1	1	1	1	2	2	2	2	2	2	2
Phase #	1	1	1	1	1	2	2	1	1	1	1	1	2	2
Time Slice #	1	2	3	4	5	1	2	1	2	3	4	5	1	2

and the four vectors would be defined as:

Energy Window Vector = 1,1,1,1,1,1,1,1,1,1,1,1,1,1,1
 Detector Vector = 1,1,1,1,1,1,1,2,2,2,2,2,2,2,2
 Phase Vector = 1,1,1,1,1,2,2,1,1,1,1,1,2,2
 Time Slice Vector = 1,2,3,4,5,1,2,1,2,3,4,5,1,2

The receiver can tell the relationship of all the frames from these four vectors. For instance, looking at the 11th value in these four vectors tells you that the 11th frame in this multi-frame object is time slice 4 of phase 1 from detector 2 and isotope 1.

The Energy Window, Detector, Phase, Rotation, R-R Interval, and Time Slot Vectors have corresponding sequence elements which contain exactly one sequence item for each of the index values in the vector. The sequence item contains a set of data elements which are specific to that group of frames, but change from one group to the next. In the above example

there would be a detector sequence element, an isotope sequence element and a phase sequence element (for dynamics, no frame sequence element is needed). The detector and phase sequence elements would contain two sequence items (because there were 2 detectors and 2 phases).

Table C.8-7
NM MULTI-FRAME MODULE ATTRIBUTES

Attribute Name	Tag	Type	Attribute Description
Frame Increment Pointer	(0028,0009)	1	Contains the Data Element Tags of one or more frame index vectors. See C.8.4.8.1.1 for further specialization.
Energy Window Vector	(0054,0010)	1C	An array which contains the energy window number for each frame. Required if the value of the Frame Increment Pointer (0028,0009) includes the Tag for Energy Window Vector (0054,0010). See C.8.4.8.1.2 for specialization.
Number of Energy Windows	(0054,0011)	1	Number of energy window groupings. See C.8.4.8.1.2 for specialization.
Detector Vector	(0054,0020)	1C	An array which contains the detector number for each frame. Required if the value of the Frame Increment Pointer (0028,0009) includes the Tag for Detector Vector (0054,0020). See C.8.4.8.1.3 for specialization.
Number of Detectors	(0054,0021)	1	Number of detectors. See C.8.4.8.1.3 for specialization.
Phase Vector	(0054,0030)	1C	An array which contains the phase number for each frame. Required if the value of the Frame Increment Pointer (0028,0009) includes the Tag for Phase Vector (0054,0030). See C.8.4.8.1.4 for specialization.
Number of Phases	(0054,0031)	1C	Number of phases. Required if the value of the Frame Increment Pointer (0028,0009) includes the Tag for Phase Vector (0054,0030). See C.8.4.8.1.4 for specialization.
Rotation Vector	(0054,0050)	1C	An array which contains the rotation number for each frame. Required if the value of the Frame Increment Pointer (0028,0009) includes the Tag for Rotation Vector (0054,0050). See C.8.4.8.1.5 for specialization.

Number of Rotations	(0054,0051)	1C	Number of rotations. Required if Image Type (0008,0008), Value 3 is TOMO, GATED TOMO, RECON TOMO, or RECON GATED TOMO. See C.8.4.8.1.5 for specialization.
R-R Interval Vector	(0054,0060)	1C	An array which contains the R-R interval number for each frame. Required if the value of the Frame Increment Pointer (0028,0009) includes the Tag for R-R Interval Vector (0054,0060). See C.8.4.8.1.6 for specialization.
Number of R-R Intervals	(0054,0061)	1C	Number of R-R intervals. Required if the value of the Frame Increment Pointer (0028,0009) includes the Tag for R-R Interval Vector (0054,0060). See C.8.4.8.1.6 for specialization.
Time Slot Vector	(0054,0070)	1C	An array which contains the time slot number for each frame. Required if the value of the Frame Increment Pointer (0028,0009) includes the Tag for Time Slot Vector (0054,0070). See C.8.4.8.1.7 for specialization.
Number of Time Slots	(0054,0071)	1C	Number of time slots. Required if the value of the Frame Increment Pointer (0028,0009) includes the Tag for Time Slot Vector (0054,0070). See C.8.4.8.1.7 for specialization.
Slice Vector	(0054,0080)	1C	An array which contains the spatial slice number for each frame. Required if the value of the Frame Increment Pointer (0028,0009) includes the Tag for Slice Vector (0054,0080). See C.8.4.8.1.8 for specialization.
Number of Slices	(0054,0081)	1C	Number of slices. Required if the value of the Frame Increment Pointer (0028,0009) includes the Tag for Slice Vector (0054,0080). See C.8.4.8.1.8 for specialization.
Angular View Vector	(0054,0090)	1C	An array which contains the angular view number for each frame. Required if the value of the Frame Increment Pointer (0028,0009) includes the Tag for Angular View Vector (0054,0090). See C.8.4.8.1.9 for specialization.

Time Slice Vector	(0054,0100)	1C	An array which contains the time slice number for each frame. Required if the value of the Frame Increment Pointer (0028,0009) includes the Tag for Time Slice Vector (0054,0100). See C.8.4.8.1.10 for specialization.
-------------------	-------------	----	---

Note: Per the rules in PS 3.5, if a data element of Type 1C or 2C is not required, it shall not be included.

C.8.4.8.1 NM Multi-Frame Attribute Descriptions

C.8.4.8.1.1 Frame Increment Pointer

By definition, NM Images are multi-dimensional Multi-frame Images. The value of the Frame Increment Pointer (0028,0009) contains the Tag for one or more frame indexing vectors. This determines the number of dimensions of frame indices in the image, and the order in which these indices vary from one frame to the next, with the last Tag indicating the most rapidly changing index. The Enumerated Values for the Frame Increment Pointer (0028,0009) are determined by the Image Type (0008,0008), Value 3, as shown in Table C.8-8.

**Table C.8-8
ENUMERATED VALUES FOR FRAME INCREMENT POINTER**

Image Type (0008,0008), Value 3	Frame Increment Pointer (0028,0009)
STATIC or WHOLE BODY	0054H 0010H \ 0054H 0020H Sequencing is by Energy Window Vector (0054,0010), Detector Vector (0054,0020).
DYNAMIC	0054H 0010H \ 0054H 0020H \ 0054H 0030H \ 0054H 0100H Sequencing is by Energy Window Vector (0054,0010), Detector Vector (0054,0020), Phase Vector (0054,0030), Time Slice Vector (0054,0100)
GATED	0054H 0010H \ 0054H 0020H \ 0054H 0060H \ 0054H 0070H Sequencing is by Energy Window Vector (0054,0010), Detector Vector (0054,0020), R-R Interval Vector(0054,0060), Time Slot Vector (0054,0070)
TOMO	0054H 0010H \ 0054H 0020H \ 0054H 0050H \ 0054H 0090H Sequencing is by Energy Window Vector (0054,0010), Detector Vector (0054,0020), Rotation Vector (0054,0050), Angular View Vector (0054,0090)
GATED TOMO	0054H 0010H \ 0054H 0020H \ 0054H 0050H \ 0054H 0060H \ 0054H 0070H \ 0054H 0090H Sequencing is by Energy Window Vector (0054,0010), Detector Vector (0054,0020), Rotation Vector (0054,0050), R-R Interval Vector (0054,0060), Time Slot Vector (0054,0070), Angular View Vector (0054,0090).
RECON TOMO	0054H 0080H Sequencing is by Slice Vector (0054,0080)

RECON GATED TOMO	0054H 0060H \ 0054H 0070H \ 0054H 0080H Sequencing is by R-R Interval Vector (0054,0060), Time Slot Vector (0054,0070), Slice Vector (0054,0080)
------------------	---

C.8.4.8.1.2 Number of Energy Windows and Energy Window Vector

Number of Energy Windows (0054,0011) is the number of distinct energy window groupings acquired in this image. See C.8.4.10.1. When Image Type (0008,0008), Value 3, is RECON TOMO or RECON GATED TOMO, then the Number of Energy Windows (0054,0011) shall be 1.

Energy Window Vector (0054,0010) is an indexing vector. The value of the n^{th} element of this vector is the energy window number for the n^{th} frame in this image, and shall have a value from 1 to Number of Energy Windows (0054,0011).

C.8.4.8.1.3 Number of Detectors and Detector Vector

Number of Detectors (0054,0021) is the number of separate detectors which differentiate the frames in this image. When Image Type (0008,0008), Value 3, is RECON TOMO or RECON GATED TOMO, then the Number of Detectors (0054,0021) shall be 1.

Note: Number of Detectors (0054,0021) does not necessarily represent the actual number of detectors used during data acquisition.

Example 1: In a TOMO acquisition in which frames from 2 or more detectors are interleaved to form one continuous set of frames, then no distinction is made between frames on the basis of which detector created them. In this case, the Number of Detectors (0054,0021) would be 1.

Example 2: In a WHOLE BODY acquisition in which a single detector acquires anterior and posterior views in two separate passes, the Number of Detectors (0054,0021) would be 2.

Detector Vector (0054,0020) is an indexing vector. The value of the n^{th} element of this vector is the detector number of the n^{th} frame in this image, and shall have a value from 1 to Number of Detectors (0054,0021).

C.8.4.8.1.4 Number of Phases and Phase Vector

Number of Phases (0054,0031) is the number of dynamic phases, independent of the number of Detectors and Isotopes. See Section C.8.4.14 for definition of a phase.

Phase Vector (0054,0030) is an indexing vector. The value of the n^{th} element of this vector is the phase number of the n^{th} frame in this image, and shall have a value from 1 to Number of Phases (0054,0031).

C.8.4.8.1.5 Number of Rotations and Rotation Vector

Number of Rotations (0054,0051) is the number of separate rotations. See Section C.8.4.12 for definition of a rotation. When Image Type (0008,0008), Value 3, is RECON TOMO, GATED TOMO or RECON GATED TOMO, then the Number of Rotations (0054,0051) shall be 1.

Rotation Vector (0054,0050) is an indexing vector. The value of the n^{th} element of this vector is the rotation number of the n^{th} frame in this image, and shall have a value from 1 to Number of Rotations (0054,0051).

C.8.4.8.1.6 Number of R-R Intervals and R-R Interval Vector

Number of R-R Intervals (0054,0061) is the number of ranges of heartbeat durations collected. A gated acquisition may employ one R-R Interval to collect data from normal beats, a second R-R Interval to collect data from ectopic beats, and possibly others. Each R-R Interval accepts beats whose duration is greater than its Low R-R Value (0018,1081) and shorter than its High R-R Value (0018,1082). Beats which do not fall within these ranges may be accepted by another R-R Interval, or may be rejected.

The Number of R-R Intervals (0054,0061) is the total number of such ranges.

R-R Interval Vector (0054,0060) is an indexing vector. The value of the n^{th} element of this vector is the interval number of the n^{th} frame in this image, and shall have a value from 1 to Number of R-R Intervals (0054,0061).

C.8.4.8.1.7 Number of Time Slots and Time Slot Vector

Number of Time Slots (0054,0071) is the number of frames into which each gating event is divided in a gated acquisition. For example, in a cardiac gated acquisition, data from a number of heartbeats are then combined by summing together the first frames from all beats into a summed first frame, all the second frames into a summed second frame, and so on. The result has the same number of frames as the Number of Time Slots in each beat.

Time Slot Vector (0054,0070) is an indexing vector. The value of the n^{th} element of this vector is the time slot number of the n^{th} frame in this image, and shall have a value from 1 to Number of Time Slots (0054,0071).

C.8.4.8.1.8 Number of Slices and Slice Vector

Number of Slices (0054,0081) is the number of slices in each separate volume.

Note: For images with Image Type (0008,0008), Value 3, equal to RECON GATED TOMO this implies that Number of Slices (0054,0081) is the same for all R-R Intervals and Time Slots.

Slice Vector (0054,0080) is an indexing vector. The value of the n^{th} element of this vector is the slice number of the n^{th} frame in this image, and shall have a value from 1 to Number of Slices (0054,0081).

C.8.4.8.1.9 Angular View Vector

Angular View Vector (0054,0090) is an indexing vector. The value of the n^{th} element of this vector is the angular view number of the n^{th} frame in this image. If Image Type (0008,0008), Value 3, is TOMO or GATED TOMO, then the value shall be from 1 to Number of Frames in Rotation (0054,0053).

C.8.4.8.1.10 Time Slice Vector

Time Slice Vector (0054,0100) is an indexing vector. The value of the n^{th} element of this vector is the time slice number of the n^{th} frame in this image, and shall have a value from 1 to Number of Frames in Phase (0054,0033).

C.8.4.9 NM Image Module

Table C.8-9 contains the Attributes that describe Nuclear Medicine Images.

**Table C.8-9
NM IMAGE MODULE ATTRIBUTES**

Attribute Name	Tag	Type	Attribute Description
Image Type	(0008,0008)	1	Image identification characteristics. See C.8.4.9.1.1 for specialization.
Image ID	(0054,0400)	3	User or equipment generated Image identifier.
Lossy Image Compression	(0028,2110)	1C	Specifies whether an Image has undergone lossy compression. Enumerated Values: 00 = Image has NOT been subjected to lossy compression. 01 = Image has been subjected to lossy compression. See C.7.6.1.1.5 Required if Lossy Compression has been performed on the Image.
Counts Accumulated	(0018,0070)	2	Sum of all gamma events for all frames in the image. See C.8.4.9.1.2 for specialization.
Acquisition Termination Condition	(0018,0071)	3	Description of how the data collection was stopped. Defined Terms: CNTS = counts DENS = density MANU = manual OVFL = data overflow TIME = time TRIG = physiological trigger See C.8.4.9.1.3 for specialization.
Table Height	(0018,1130)	3	The height of the patient table in mm. The range and values of this element are determined by the manufacturer. Should not be included if Image Type (0008,0008), Value 3, is TOMO, GATED TOMO, RECON TOMO or RECON GATED TOMO.

Table Traverse	(0018,1131)	3	Location of the patient table (or gantry relative to the table) in mm. The range and values of this element are determined by the manufacturer. Should not be included if Image Type (0008,0008), Value 3, is TOMO, GATED TOMO, RECON TOMO or RECON GATED TOMO.
Actual Frame Duration	(0018,1242)	1C	Elapsed time for data acquisition in msec. Required if Image Type (0008,0008) Value 3 is: WHOLE BODY or STATIC. See C.8.4.9.1.4 for specialization.
Count Rate	(0018,1243)	3	Maximum count rate achieved during the acquisition in counts/sec.
Processing Function	(0018,5020)	3	Code or description of processing functions applied to the data.
Corrected Image	(0028,0051)	3	A value that indicates which, if any, corrections have been applied to the image. Corrections are applied to all frames in the image. Defined Terms: UNIF = flood corrected COR = center of rotation corrected NCO = non-circular orbit corrected DECY = decay corrected ATTN = attenuation corrected SCAT = scatter corrected DTIM = dead time corrected NRGY = energy corrected LIN = linearity corrected MOTN = motion corrected CLN = count loss normalization; Any type of normalization applied to correct for count loss in Time Slots.
Whole Body Technique	(0018,1301)	3	The type of scan performed. Used only if Image Type (0008,0008), Value 3, contains the value WHOLE BODY. Enumerated Values: 1PS = one pass 2PS = two pass PCN = patient contour following employed MSP = multiple static frames collected into a whole body frame.

Scan Velocity	(0018,1300)	2C	The speed of the camera motion over the body in mm/sec. Required if Image Type (0008,0008) Value 3 contains the value WHOLE BODY.
Scan Length	(0018,1302)	2C	Size of the imaged area in the direction of scanning motion, in mm. Required if Image Type (0008,0008) Value 3 contains the value WHOLE BODY.
Referenced Overlay Sequence	(0008,1130)	3	A sequence which provides reference to a set of SOP Class/Instance pairs which are related independent Overlays. Uniquely identifies Overlays significantly related to this Image. Zero or more Items may be included in this sequence.
>Referenced SOP Class UID	(0008,1150)	1C	Uniquely identifies the referenced SOP Class. Required if a sequence Item is present.
>Referenced SOP Instance UID	(0008,1155)	1C	Uniquely identifies the referenced SOP Instance. Required if a sequence Item is present.
Referenced Curve Sequence	(0008,1145)	3	A sequence which provides reference to a set of SOP Class/Instance pairs which are related independent Curves. Uniquely identifies Curves significantly related to this Image. Zero or more Items may be included in this sequence.
>Referenced SOP Class UID	(0008,1150)	1C	Uniquely identifies the referenced SOP Class. Required if a sequence Item is present.
>Referenced SOP Instance UID	(0008,1155)	1C	Uniquely identifies the referenced SOP Instance. Required if a sequence Item is present.
Trigger Source or Type	(0018,1061)	3	Text indicating trigger source. Defined Term: EKG
Anatomic Region Sequence	(0008,2218)	3	Sequence of one Item that identifies the anatomic region of interest in this image (i.e. external anatomy, surface anatomy, or general region of the body). See Section C.8.4.9.1.5.
>Include 'Code Sequence Macro' Table 8.8-1		Baseline Context ID is 1. Code Meaning (0008,0104) shall be Type 3 for historical reasons.	
>Anatomic Region Modifier Sequence	(0008,2220)	3	Sequence of one or more Items that modifies the anatomic region of interest in this image (i.e. prone, supine, decubitus right). See Section C.8.4.9.1.5.

>>Include 'Code Sequence Macro' Table 8.8-1		Baseline Context ID is 2. Code Meaning (0008,0104) shall be Type 3 for historical reasons.	
Primary Anatomic Structure Sequence	(0008,2228)	3	Sequence of one or more Items that identifies the primary anatomic structure of interest in this image. See Section C.8.4.9.1.6.
>Include 'Code Sequence Macro' Table 8.8-1		Baseline Context ID is 1. Code Meaning (0008,0104) shall be Type 3 for historical reasons.	
>Primary Anatomic Structure Modifier Sequence	(0008,2230)	3	Sequence of one or more Items that modifies the primary anatomic structure of interest in this image. See Section C.8.4.9.1.6.
>>Include 'Code Sequence Macro' Table 8.8-1		Baseline Context ID is 2. Code Meaning (0008,0104) shall be Type 3 for historical reasons.	

Note: Content Date (0008,0023) and Content Time (0008,0033) are included in the General Image Module, Table C.7-7, whenever the images are temporally related. For this purpose, all NM Images are considered temporally related, so that these elements are included in an NM Image.

C.8.4.9.1 NM Image Module Attribute Descriptions

C.8.4.9.1.1 Image Type

For NM images, Image Type (0008,0008) Value 3 is specified to be Type 1 and use one of the following Enumerated Values:

STATIC
DYNAMIC
GATED
WHOLE BODY
TOMO
GATED TOMO
RECON TOMO
RECON GATED TOMO

For NM images, Image Type (0008,0008) Value 4 is specified to use one of the following Enumerated Values:

EMISSION
TRANSMISSION

Note: For NM images, Image Type (0008,0008) Value 1 will be ORIGINAL for all raw data and reconstructed images. DERIVED may be appropriate for some other results images.

For NM images, Image Type (0008,0008) Value 2 will be PRIMARY.

C.8.4.9.1.2 Counts Accumulated

Counts Accumulated (0018,0070) is the total of all gamma events accumulated in all frames of this Image. This attribute applies to acquisition data, and often does not apply to processed images (DERIVED, SECONDARY).

C.8.4.9.1.3 Acquisition Termination Condition

Acquisition Termination Condition (0018,0071) is the method of acquisition termination which was actually applied to the data collection. The Defined Terms and definitions are:

CNTS	=	preset count limit was reached
DENS	=	preset count density was reached
MANU	=	acquisition was terminated manually
OVFL	=	acquisition was terminated automatically by pixel data overflow condition
TIME	=	preset time limit was reached
TRIG	=	preset number of physiological triggers was reached

C.8.4.9.1.4 Actual Frame Duration

Actual Frame Duration (0018,1242) is defined as the elapsed time in msec for a single frame of an acquisition. For some types of multi-frame images, Actual Frame Duration (0018,1242) may have a more specialized meaning as defined in the appropriate IOD Module.

C.8.4.9.1.5 Anatomic Region

The general region of the body (e.g. the anatomic region, organ, or body cavity being examined) may be identified by the Anatomic Region Sequence (0008,2218). Characteristics of the anatomic region being examined, such as its orientation relative to gravity (e.g. prone, supine, semi-erect), sub-region (e.g. medial, lateral, superior, inferior, lobe, quadrant), and laterality (e.g. right, left, both), and so on, may be refined by the Anatomic Region Modifier Sequence (0008,2220).

Note: These Attributes allow the specification of the information encoded by the Body Part Examined (0018,0015) and Patient Position (0018,5100) Attributes (in the General Series Module) in a more robust, consistent way.

C.8.4.9.1.6 Primary Anatomic Structure

The specific anatomic structures of interest within the image (e.g. a particular artery within the anatomic region) is identified by the Primary Anatomic Structure Sequence (0008,2228). Characteristics of the anatomic structure, such as its location (e.g. subcapsular, peripheral, central), configuration (e.g. distended, contracted), and laterality (e.g. right, left, both), and so on, may be refined by the Primary Anatomic Structure Modifier Sequence (0008,2230).

Note: These Attributes are intended to replace the Anatomic Structure (0008,2208) Attribute.

C.8.4.10 NM Isotope Module

Table C.8-10 contains Attributes that describe the isotope administered for the acquisition.

**Table C.8-10
NM ISOTOPE MODULE ATTRIBUTES**

Attribute Name	Tag	Type	Attribute Description
Energy Window Information Sequence	(0054,0012)	2	Sequence of Repeating Items that describe the energy window groups used. The number of items shall be equal to Number of Energy Windows (0054,0011). The first item corresponds to frames with value of 1 in the Energy Window Vector (0054,0010), the second item with value 2, etc.
>Energy Window Name	(0054,0018)	3	A user defined name which describes this Energy Window.
>Energy Window Range Sequence	(0054,0013)	3	Sequence of Repeating Items that describes this energy window group.
>>Energy Window Lower Limit	(0054,0014)	3	The lower limit of the energy window in KeV. See C.8.4.10.1.1 for further explanation.
>>Energy Window Upper Limit	(0054,0015)	3	The upper limit of the energy window in KeV. See C.8.4.10.1.2 for further explanation.
Radiopharmaceutical Information Sequence	(0054,0016)	2	Sequence of Repeating Items that describe isotope information. One or more Items may be included in this sequence.
>Radionuclide Code Sequence	(0054,0300)	2C	Sequence that identifies the radionuclide. This sequence shall contain exactly one item. Required if a sequence Item is present.
>>Include 'Code Sequence Macro' Table 8.8-1			<p><i>Baseline Context ID is 18.</i></p> <p><i>The Coding Scheme Designator (0008,0102) shall have an Enumerated Value of "99SDM" for historical reasons.</i></p> <p><i>Code Meaning (0008,0104) shall be Type 3 for historical reasons.</i></p>
>Radiopharmaceutical Route	(0018,1070)	3	Route of injection.
>Administration Route Code Sequence	(0054,0302)	3	Sequence that identifies the administration route for the radiopharmaceutical. This sequence shall contain exactly one item.
>>Include 'Code Sequence Macro' Table 8.8-1			<p><i>Baseline Context ID is 11.</i></p> <p><i>Code Meaning (0008,0104) shall be Type 3 for historical reasons.</i></p>
>Radiopharmaceutical Volume	(0018,1071)	3	Volume of injection in cubic cm.
>Radiopharmaceutical Start Time	(0018,1072)	3	Time of start of injection. See C.8.4.10.1.5 for further explanation.

>Radiopharmaceutical Stop Time	(0018,1073)	3	Time of end of injection. See C.8.4.10.1.6 for further explanation.
>Radionuclide Total Dose	(0018,1074)	3	Total amount of radionuclide injected. See C.8.4.10.1.7 for further explanation.
>Calibration Data Sequence	(0054,0306)	3	Sequence that contains calibration data.
>>Energy Window Number	(0054,0308)	1C	The Item number in the Energy Window Information Sequence to which the following calibration data relates. The Items are numbered starting from 1. Required if a sequence Item is present.
>>Syringe Counts	(0018,1045)	3	Pre-injection syringe count rate in counts/sec. See C.8.4.10.1.8 for further explanation.
>>Residual Syringe Counts	(0054,0017)	3	Post-injection residue syringe count rate in counts/sec. See C.8.4.10.1.9 for further explanation.
>Radiopharmaceutical	(0018,0031)	3	Name of the radiopharmaceutical.
>Radiopharmaceutical Code Sequence	(0054,0304)	3	Sequence that identifies the radiopharmaceutical. This sequence shall contain exactly one item.
>>Include 'Code Sequence Macro' Table 8.8-1		<i>Baseline Context ID is 25. Code Meaning (0008,0104) shall be Type 3 for historical reasons.</i>	
Intervention Drug Information Sequence	(0018,0026)	3	Sequence of Repeating Items that describes the intervention drugs used. Zero or more Items may be included in this sequence.
>Intervention Drug Name	(0018,0034)	3	Name of intervention drug.
>Intervention Drug Code Sequence	(0018,0029)	3	Sequence that identifies the intervention drug name.
>>Include 'Code Sequence Macro' Table 8.8-1		<i>Baseline Context ID is 10. Code Meaning (0008,0104) shall be Type 3 for historical reasons.</i>	
>Administration Route Code Sequence	(0054,0302)	3	Sequence that identifies the administration route for the intervention drug. This sequence shall contain exactly one item.
>>Include 'Code Sequence Macro' Table 8.8-1		<i>Baseline Context ID is 11. Code Meaning (0008,0104) shall be Type 3 for historical reasons.</i>	
>Intervention Drug Start Time	(0018,0035)	3	Time of administration of the intervention drug, using the same time base as for the Acquisition Start Time (0008,0032).

>Intervention Drug Stop Time	(0018,0027)	3	Time of completion of administration of the intervention drug, using the same time base as for the Acquisition Start Time (0008,0032).
>Intervention Drug Dose	(0018,0028)	3	Intervention drug dose, in mg.

C.8.4.10.1 NM Isotope Module Attribute Descriptions

C.8.4.10.1.1 Energy Window Lower Limit

Energy Window Lower Limit (0054,0014) is the acquisition energy window lower limit in KeV for acceptance of scintillation events into this Isotope.

C.8.4.10.1.2 Energy Window Upper Limit

Energy Window Upper Limit (0054,0015) is the acquisition energy window upper limit in KeV for acceptance of scintillation events into this Isotope.

C.8.4.10.1.3 (Retired)

C.8.4.10.1.4 (Retired)

C.8.4.10.1.5 Radiopharmaceutical Start Time

Radiopharmaceutical Start Time (0018,1072) is the actual time of radiopharmaceutical administration to the patient for imaging purposes, using the same time base as for the Acquisition Start Time (0008,0032).

C.8.4.10.1.6 Radiopharmaceutical Stop Time

Radiopharmaceutical Stop Time (0018,1073) is the actual ending time of radiopharmaceutical administration to the patient for imaging purposes, using the same time base as for the Acquisition Start Time (0008,0032).

C.8.4.10.1.7 Radionuclide Total Dose

Radionuclide Total Dose (0018,1074) is the radiopharmaceutical dose administered to the patient measured in MegaBecquerels (Mbc) at the Radiopharmaceutical Start Time.

C.8.4.10.1.8 Syringe Counts

Syringe Counts (0018,1045) is the pre-injection syringe acquisition count rate measured in counts/sec, corrected to the Acquisition Start Time (0008,0032) if necessary.

C.8.4.10.1.9 Residual Syringe Counts

Residual Syringe Counts (0054,0017) is the syringe acquisition count rate following patient injection, measured in counts/sec, corrected to the Acquisition Start Time (0008,0032) if necessary.

C.8.4.10.1.10 (Retired)

C.8.4.10.1.11 (Retired)

C.8.4.11 NM Detector Module

Table C.8-11 contains IOD Attributes that describe Nuclear Medicine Detectors used to produce an image.

**Table C.8-11
NM DETECTOR MODULE ATTRIBUTES**

Attribute Name	Tag	Type	Attribute Description
Detector Information Sequence	(0054,0022)	2	Sequence of Repeating Items that describe the detectors used. The number of items shall be equal to Number of Detectors (0054,0021). The first item corresponds to frames with value of 1 in the Detector Vector (0054,0020), the second item with value 2, etc.
>Collimator/Grid Name	(0018,1180)	3	Label describing the collimator used (LEAP, hires, etc.)
>Collimator Type	(0018,1181)	2C	Collimator type. Defined Terms: PARA = Parallel (default) PINH = Pinhole FANB = Fan-beam CONE = Cone-beam SLNT = Slant hole ASTG = Astigmatic DIVG = Diverging NONE = No collimator UNKN = Unknown Required if a sequence Item is present.
>Field of View Shape	(0018,1147)	3	Shape of the field of view of the Nuclear Medicine detector. Defined Terms: RECTANGLE ROUND HEXAGONAL
>Field of View Dimension(s)	(0018,1149)	3	Dimensions of the field of view, in mm. If Field of View Shape (0018,1147) is: RECTANGLE: row dimension followed by column. ROUND: diameter. HEXAGONAL: diameter of a circumscribed circle.
>Focal Distance	(0018,1182)	2C	Focal distance, in mm. A value of 0 means infinite distance for parallel collimation. See C.8.4.11.1.1 for further specialization. Required if a sequence Item is present.
>X Focus Center	(0018,1183)	3	Center of focus along a row. See C.8.4.11.1.2 for further explanation.

>Y Focus Center	(0018,1184)	3	Center of focus along a column. See C.8.4.11.1.2 for further explanation.
>Zoom Center	(0028,0032)	3	The amount of offset from (0,0) applied to each pixel in the image before application of the zoom factor, specified by a numeric pair: row value (delimiter) column value (in mm). See C.8.4.11.1.3 for further explanation.
>Zoom Factor	(0028,0031)	3	The amount of magnification applied to each pixel in the image, specified by a numeric pair: row value (delimiter) column value. See C.8.4.11.1.4 for further explanation.
>Center of Rotation Offset	(0018,1145)	3	Average center of rotation offset of Nuclear Medicine detector in mm. See C.8.4.11.1.5 for further explanation.
>Gantry/Detector Tilt	(0018,1120)	3	Angle of tilt in degrees of the detector. See C.8.4.11.1.6 for further explanation.
>Distance Source to Detector	(0018,1110)	2C	Distance in mm from transmission source to the detector face. Required if Image Type (0008,0008) Value 4 is TRANSMISSION, Value 3 is not TOMO, and a sequence Item is present.
>Start Angle	(0054,0200)	3	Position of the detector about the patient for the start of the acquisition, in degrees. Zero degrees is referenced to the origin at the patient's back. Viewing from the patient's feet, angle increases in a counter-clockwise direction (detector normal rotating from the patient's back towards the patient's left side). Should not be included if Image Type (0008,0008), Value 3, is TOMO, GATED TOMO, RECON TOMO or RECON GATED TOMO.
> Radial Position	(0018,1142)	3	Radial distance of the detector from the center of rotation, in mm. Should not be included if Image Type (0008,0008), Value 3, is TOMO, GATED TOMO, RECON TOMO or RECON GATED TOMO.
>Image Orientation (Patient)	(0020,0037)	2C	The direction cosines of the first row and the first column with respect to the patient. See C.7.6.2.1.1 for further explanation. Required if a sequence Item is present.

>Image Position (Patient)	(0020,0032)	2C	The x, y, and z coordinates of the upper left hand corner (center of the first voxel transmitted) of the image, in mm. See C.7.6.2.1.1 for further explanation. Required if a sequence Item is present.
>View Code Sequence	(0054,0220)	3	Sequence that describes the projection of the anatomic region of interest on the image receptor. See Section C.8.4.11.1.7 for further explanation.
>>Include 'Code Sequence Macro' Table 8.8-1		<i>Baseline Context ID is 26 . Code Meaning (0008,0104) shall be Type 3 for historical reasons.</i>	
>>View Modifier Code Sequence	(0054,0222)	2C	View Modifier. Required if needed to fully specify the View. See Section C.8.4.11.1.8 for further explanation.
>>>Include 'Code Sequence Macro' Table 8.8-1		<i>Baseline Context ID is 23. Code Meaning (0008,0104) shall be Type 3 for historical reasons.</i>	

C.8.4.11.1 NM Detector Attribute Descriptions

C.8.4.11.1.1 Focal Distance

Focal Distance (0018,1182) for NM Image data is the focal distance, in mm for converging or diverging collimators, measured from the front face of the detector to the focus. Positive values indicate converging and negative values indicate diverging collimators. A value of 0 means infinite distance for parallel collimation.

C.8.4.11.1.2 Focus Center

X Focus Center (0018,1183) and Y Focus Center (0018,1184) for NM Image data is used to define the projection of the focus for a converging or diverging collimator within the un-zoomed Field of View. It is defined in mm for row and column relative to the center of the un-zoomed Field of View.

C.8.4.11.1.3 Zoom Center

Zoom Center (0028,0032) is the offset between the un-zoomed camera field of view and field of view, measured from the center of the un-zoomed camera field of view to the center the of the zoomed field of view. The offset is measured in mm in the un-zoomed camera FOV dimensions. Positive values are to the right and down from the un-zoomed center, as viewed from the image plane. When this attribute is not given, the Zoom Center is assumed to be 0\0.

C.8.4.11.1.4 Zoom Factor

Zoom Factor (0028,0031) is the magnification factor that was used during the acquisition. When this attribute is not given, it is assumed to be 1.0\1.0.

Note: Zoom Factor (0028,0031) is informational only. Pixel Spacing (0028,0030) already takes account of this and any other changes to pixel size.

C.8.4.11.1.5 Center of Rotation Offset

Center of Rotation Offset (0018,1145) is the average amount of offset in mm between the Detector Field of View center and the physical center of rotation of the gantry for circular orbital scans. Positive values indicate the physical center is to the right of the image plane center.

C.8.4.11.1.6 Gantry/Detector Tilt

Gantry/Detector Tilt (0018,1120) for NM Image data is the angle in degrees of the detector face relative to the patient's major (Head to Feet) axis (or the table supporting the patient). Positive tilt is towards the patient's feet.

C.8.4.11.1.7 View Code Sequence

Only a single Item shall be permitted in this sequence.

C.8.4.11.1.8 View Modifier Code Sequence

Only a single Item shall be permitted in this sequence.

C.8.4.12 NM TOMO Acquisition Module

This Module applies to a TOMO Multi-frame Image. This module is present when the Image Type (0008,0008) Value 3, is equal to TOMO, GATED TOMO, RECON TOMO, or RECON GATED TOMO. The elements found in this module describe the acquisition of the Image.

**Table C.8-12
NM TOMO ACQUISITION MODULE ATTRIBUTES**

Attribute Name	Tag	Type	Attribute Description
Rotation Information Sequence	(0054,0052)	2	Sequence of Repeating Items that describe TOMO rotational groups. A new rotation is defined whenever the direction of the detector motion changes, or the Table Traverse (0018,1131) changes. The number of items shall be equal to Number of Rotations (0054,0051). If Rotation Vector (0054,0050) is present, the first item corresponds to frames with value of 1 in the Rotation Vector (0054,0050), the second item with value 2, etc.
>Start Angle	(0054,0200)	1C	Position of the detector about the patient for the start of this rotation, in degrees. Zero degrees is referenced to the origin at the patient's back. Viewing from the patient's feet, angle increases in a counter-clockwise direction (detector normal rotating from the patient's back towards the patient's left side). Required if a sequence Item is present.
>Angular Step	(0018,1144)	1C	The angular scan arc step between views of the TOMO acquisition, in degrees. See C.8.4.12.1.1 for further explanation. Required if a sequence Item is present.

>Rotation Direction	(0018,1140)	1C	Direction of rotation of the detector about the patient. See Start Angle (0054,0200) for further explanation of direction. Enumerated Values: CW = clockwise (decreasing angle) CC = counter-clockwise (increasing angle). Required if a sequence Item is present.
>Scan Arc	(0018,1143)	1C	The effective angular range of the scan data in degrees. The value shall be positive. Required if a sequence Item is present.
>Actual Frame Duration	(0018,1242)	1C	Nominal acquisition time per angular position, in msec. Required if a sequence Item is present.
>Radial Position	(0018,1142)	3	Radial distance of the detector from the center of rotation, in mm. It shall have a single value which is an average value for this rotation, or it shall have one value per angular view.
>Distance Source to Detector	(0018,1110)	2C	Distance in mm from transmission source to the detector face. Required if Image Type (0008,0008), Value 4, is TRANSMISSION and a sequence Item is present.
>Number of Frames in Rotation	(0054,0053)	1C	Number of angular views in this rotation. Required if a sequence Item is present.
>Table Traverse	(0018,1131)	3	Location of the patient table (or gantry relative to the table) in mm. The range and values of this element are determined by the manufacturer.
>Table Height	(0018,1130)	3	The distance in mm of the top of the patient table to the center of rotation. Table height below the center of rotation has a positive value.
Type of Detector Motion	(0054,0202)	3	Describes the detector motion during acquisition. Enumerated Values: STEP AND SHOOT = Interrupted motion, acquire only while stationary. CONTINUOUS = Gantry motion and acquisition are simultaneous and continuous. ACQ DURING STEP = Interrupted motion, acquisition is continuous.

C.8.4.12.1 NM TOMO Acquisition Attribute Descriptions

C.8.4.12.1.1 Angular Step

Angular Step (0018,1144) is the nominal frame-to-frame incremental angle for TOMO and GATED TOMO acquisition images, defined in degrees. The Angular Step (0018,1144) shall be a positive

number. Summation of Angular Step values is not defined to give accurate Angular Position or Scan Arc values. The Angular Step is the effective angular spacing between resultant frames of the Multi-framed planar image data.

C.8.4.13 NM Multi-gated Acquisition Module

Table C.8-13 contains Attributes that describe a multi-gated acquisition image performed on the patient. This refers to frames acquired while the patient is connected to a gating device.

**Table C.8-13
NM MULTI-GATED ACQUISITION MODULE ATTRIBUTES**

Attribute Name	Tag	Type	Attribute Description
Beat Rejection Flag	(0018,1080)	3	Heart beat duration sorting has been applied. Enumerated Values: Y = yes N = no
PVC Rejection	(0018,1085)	3	Description of type of arrhythmic beat rejection criteria used.
Skip Beats	(0018,1086)	3	Number of beats skipped after a detected arrhythmia
Heart Rate	(0018,1088)	3	Average number of heart beats per minute for the collection period for these frames. This shall include all accepted beats as well as rejected beats.
Gated Information Sequence	(0054,0062)	2C	Sequence of Repeating Items that describe R-R intervals. Each gated interval is defined by an upper and lower range of heart beat durations. Required if the Frame Increment Pointer (0028,0009) contains the Tag for R-R Interval Vector (0054,0060). The number of items shall be equal to Number of R-R Intervals (0054,0061). The first item corresponds to frames with value of 1 in the R-R Interval Vector (0054,0060), the second item with value 2, etc.
>Trigger Time	(0018,1060)	3	Time interval measured in msec from the start of the R-wave to the beginning of the data taking.
>Framing Type	(0018,1064)	3	Description of type of framing performed such as forward, backward, forward/backward by percentage.
>Data Information Sequence	(0054,0063)	2C	Sequence of Repeating Items that describe gating criteria. See C.8.4.13.1.1. Required if a sequence Item is present.
>>Frame Time	(0018,1063)	1C	Nominal time per individual frame in msec. Required if a sequence Item is present.
>>Nominal Interval	(0018,1062)	3	Average duration of accepted beats, in msec.

>>Low R-R Value	(0018,1081)	3	R-R interval lower limit for beat rejection, in msec
>>High R-R Value	(0018,1082)	3	R-R interval upper limit for beat rejection, in msec
>>Intervals Acquired	(0018,1083)	3	Number of heartbeats that fall within Low R-R Value (0018,1081) and High R-R Value (0018,1082), and were therefore accepted and contribute gamma events to this R-R Interval.
>>Intervals Rejected	(0018,1084)	3	Number of heartbeats that fall outside Low R-R (0018,1081) and High R-R Value (0018,1082), and do not contribute gamma events to this R-R Interval. However, they may contribute gamma events to other R-R Intervals.
>>Time Slot Information Sequence	(0054,0072)	2C	Sequence of Repeating Items that describe Time Slot Information. Required if the Frame Increment Pointer (0028,0009) contains the Tag for Time Slot Vector (0054,0070). The number of items shall be equal to Number of Time Slots (0054,0071). The first item corresponds to frames with value of 1 in the Time Slot Vector (0054,0070), the second item with value 2, etc.
>>>Time Slot Time	(0054,0073)	3	The total amount of time, in msec, that the acquisition accumulates gamma events into this frame. See C.8.4.13.1.2.

C.8.4.13.1 NM Multi-gated Acquisition Attribute Descriptions

C.8.4.13.1.1 Data Information Sequence

Data Information Sequence (0054,0063) shall contain a single sequence item which applies to the sum of all angular views, except when Image Type (0008,0008) Value 3 is GATED TOMO. In this case it shall have either a single item which applies to the sum of all angular views, or it shall have one item for each angular view.

C.8.4.13.1.2 Time Slot Time

The Time Slot Time (0054,0073) records the effective imaging time of each Time Slot. For example, if some of the accepted beats are shorter than others then the last frames may not receive a contribution from the shorter beats. The Time Slot Time for a Time Slot is the total acquisition time for that Time Slot. It is approximately equal to the Frame Time (0018,1063) multiplied by the number of accepted beats contributing to the Time Slot.

C.8.4.14 NM Phase Module

Table C.8-14 contains Attributes that describe dynamic phases of a dynamic acquisition image performed on the patient. This module is present only when Image Type (0008,0008), Value 3, is equal to DYNAMIC. A phase is defined as a collection of frames in which the acquisition time per frame and the time delay between frames remains constant. A new phase shall be defined whenever

there is a change in the time between frames, the acquisition time per frame, or the position of the patient relative to the detector.

Table C.8-14
NM PHASE MODULE ATTRIBUTES

Attribute Name	Tag	Type	Attribute Description
Phase Information Sequence	(0054,0032)	2C	Sequence of Repeating Items that describes each dynamic phase. Required if the Frame Increment Pointer (0028,0009) contains the Tag for Phase Vector (0054,0030). The number of items shall be equal to Number of Phases (0054,0031). The first item corresponds to frames with value of 1 in the Phase Vector (0054,0030), the second item with value 2, etc.
>Phase Delay	(0054,0036)	1C	Time paused between the last frame of the previous phase and the first frame of this phase, in msec. Required if a sequence Item is present.
>Actual Frame Duration	(0018,1242)	1C	Nominal time of acquisition per individual frame, in msec. Required if a sequence Item is present.
>Pause Between Frames	(0054,0038)	1C	Time paused between each frame of this phase (in msec). Required if a sequence Item is present.
>Number of Frames in Phase	(0054,0033)	1C	Number of frames in this phase. Required if a sequence Item is present.
>Trigger Vector	(0054,0210)	3	An array of trigger times when gating information is acquired simultaneously with the dynamic image data. See Section C.8.4.14.1.1 for further explanation.
>Number of Triggers in Phase	(0054,0211)	1C	The number of entries in the Trigger Vector (0054,0210) for this phase. Required if Trigger Vector (0054,0210) is present.

C.8.4.14.1 NM Phase Module Attributes Description

C.8.4.14.1.1 Trigger Vector

Trigger Vector (0054,0210) is an array containing a list of the inter-trigger interval times in milliseconds in the order in which they were acquired, with the first being measured from the start time of the first frame of the image data in the Phase. If this element is used, the start times are required to be the same so that a mathematical correlation can be made between trigger times and frame start times.

C.8.4.15 NM Reconstruction Module

Table C.8-15 contains Attributes that describe Nuclear Medicine reconstructed volumes. Reconstructed volumes are created by applying a transformation (reconstruction) process to the acquired TOMO frames. This module is present only when the Image Type (0008,0008), Value 3, is equal to RECON TOMO or RECON GATED TOMO.

Table C.8-15
NM RECONSTRUCTION MODULE ATTRIBUTES

Attribute Name	Tag	Type	Attribute Description
Spacing Between Slices	(0018,0088)	2	Spacing between slices, in mm, measured from center-to-center of each slice along the normal to the first image. The sign of the Spacing Between Slices (0018,0088) determines the direction of stacking. The normal is determined by the cross product of the direction cosines of the first row and first column of the first frame, such that a positive spacing indicates slices are stacked behind the first slice and a negative spacing indicates slices are stacked in front of the first slice. See Image Orientation (0020,0037) in the NM Detector module.
Reconstruction Diameter	(0018,1100)	3	Diameter, in mm, of the region from within which the data was used in creating the reconstruction of the image. Data may exist outside this region and portions of the patient may exist outside this region.
Convolution Kernel	(0018,1210)	3	A label describing the convolution kernel or algorithm used to reconstruct the data.
Slice Thickness	(0018,0050)	2	Nominal slice thickness, in mm.
Slice Location	(0020,1041)	3	Relative position of exposure expressed in mm. See C.7.6.2.1.2 for further explanation.

C.8.5 Ultrasound Modules

This Section describes Ultrasound Frame of Reference and Image Modules. These Modules contain Attributes that are specific to Ultrasound images.

C.8.5.1 US Frame of Reference Module (Retired)

Section C.8.4.1 was defined in a previous version of the DICOM Standard. The Section is now retired.

C.8.5.2 US Region Calibration (Retired)

Section C.8.4.2 was defined in a previous version of the DICOM Standard. The Section is now retired.

C.8.5.3 US Image Module (Retired)

Section C.8.4.3 was defined in a previous version of the DICOM Standard. The Section is now retired.

C.8.5.4 US Frame of Reference Module

Table C.8-16 contains IOD Attributes that describe an ultrasound frame of reference.

Table C.8-16
US FRAME OF REFERENCE MODULE ATTRIBUTES

Attribute Name	Tag	Type	Attribute Description
Region Location Min x_0	(0018,6018)	1	The bounds of a rectangle specifying the location of the region, x_0, y_0, x_1, y_1 . See C.8.5.4.1.1 for further explanation.
Region Location Min y_0	(0018,601A)	1	The bounds of a rectangle specifying the location of the region, x_0, y_0, x_1, y_1 . See C.8.5.4.1.1 for further explanation.
Region Location Max x_1	(0018,601C)	1	The bounds of a rectangle specifying the location of the region, x_0, y_0, x_1, y_1 . See C.8.5.4.1.1 for further explanation.
Region Location Max y_1	(0018,601E)	1	The bounds of a rectangle specifying the location of the region, x_0, y_0, x_1, y_1 . See C.8.5.4.1.1 for further explanation.
Physical Units X Direction	(0018,6024)	1	The physical units of the dimensions of the region. See C.8.5.4.1.2 for Enumerated Values.
Physical Units Y Direction	(0018,6026)	1	The physical units of the dimensions of the region. See C.8.5.4.1.2 for Enumerated Values.
Physical Delta X	(0018,602C)	1	The physical value increments per positive X pixel increment. The units are as specified in the Physical units data element.

Physical Delta Y	(0018,602E)	1	The physical value increments per positive Y pixel increment. The units are as specified in the Physical units data element.
Reference Pixel x_0	(0018,6020)	3	This coordinate pair, x_0, y_0 defines the location of a virtual "reference" pixel. See C.8.5.4.1.3 for further explanation.
Reference Pixel y_0	(0018,6022)	3	This coordinate pair, x_0, y_0 defines the location of a virtual "reference" pixel. See C.8.5.4.1.3 for further explanation.
Ref. Pixel Physical Value X	(0018,6028)	3	The Physical Value at the reference pixel x location. The units are specified in the Physical Units field.
Ref. Pixel Physical Value Y	(0018,602A)	3	The Physical Value at the reference pixel y location. The units are specified in the Physical Units field.

C.8.5.4.1 US Frame of Reference Attribute Definitions

C.8.5.4.1.1 Region Location Min x_0 , Region Location Min y_0 , Region Location Max x_1 , Region Location Max y_1

The bounds of a rectangle specifying the location of the region, Region Location Min x_0 (0018,6018), Region Location Min y_0 (0018,601A), Region Location Max x_1 (0018,601C), Region Location Max y_1 (0018,601E). The upper left corner of the entire image is $x=0, y=0$ and the lower right corner is $x=\text{image width} - 1$, and $y=\text{image length} - 1$. Thus, a region will be specified as within these bounds. Where x_0, y_0 is the coordinate of the upper left corner of the region and x_1, y_1 is the coordinate of the lower right corner of the region.

C.8.5.4.1.2 Physical Units X Direction And Physical Units Y Direction

Physical Units X Direction (0018,6024) and Physical Units Y Direction (0018,6026) provide Enumerated Values indicating the physical units of the dimensions of the region.

Value	Meaning	Value	Meaning
0000H	= None or not applicable	0001H	= Percent
0002H	= dB	0003H	= cm
0004H	= seconds	0005H	= hertz(seconds ⁻¹)
0006H	= dB/seconds	0007H	= cm/sec
0008H	= cm ²	0009H	= cm ² /sec
000AH	= cm ³	000BH	= cm ³ /sec
000CH	= degrees		

C.8.5.4.1.3 Reference Pixel x_0 and Reference Pixel y_0

This coordinate pair, Reference Pixel x_0 (0018,6020), Reference Pixel y_0 (0018,6022) defines the location of a virtual "reference" pixel. The reference pixel is used to tie the image's pixel coordinate system to the physical coordinate system. For example, the reference pixel could be defined where a depth of zero centimeters occurs in the 2D image, or it could define where the baseline (i.e.: zero frequency) resides in a spectral display. The reference pixel location is the relative offset from the region location, not necessarily the image origin. The location is not required to be within the region or even within the image boundary. For this reason, the Reference Pixel Location can be positive or negative.

Recommended locations are:

- Sector - Skin line
- Linear - Skin line left corner
- Doppler Spectral - Baseline left
- M-Mode - Skin line left
- Physio - Baseline left (where baseline = 0)

C.8.5.5 US Region Calibration Module

The US Region Calibration Module has been introduced into the ultrasound IOD to provide access to the full range of data which may be present in a single US image. US images often contain multiple regions which have independent data regions, e.g. quad screen loops which may have different calibration information. The data presented in the various regions of a US image can represent a multiplicity of physical parameters, e.g., spatial distance, blood velocity, time, volume, etc., and these are often contained in the value of the pixel itself. It is therefore imperative that physical information be available for the various regions of a single region independent of each other.

C.8.5.5.1 US Region Calibration Attribute Definitions

Table C.8-17 contains IOD Attributes that describe an ultrasound region calibration.

Table C.8-17
US REGION CALIBRATION MODULE ATTRIBUTES

Attribute Name	Tag	Type	Attribute Description
Sequence of Ultrasound Regions	(0018,6011)	1	Defines a sequence of Ultrasound Regions. One or more Items may be included in this Sequence.
>Region Location Min x_0	(0018,6018)	1	The bounds of a rectangle specifying the location of the region, x_0, y_0, x_1, y_1 . See C.8.5.4.1.1 for further explanation.
>Region Location Min y_0	(0018,601A)	1	The bounds of a rectangle specifying the location of the region, x_0, y_0, x_1, y_1 . See C.8.5.4.1.1 for further explanation.
>Region Location Max x_1	(0018,601C)	1	The bounds of a rectangle specifying the location of the region, x_0, y_0, x_1, y_1 . See C.8.5.4.1.1 for further explanation.

>Region Location Max y_1	(0018,601E)	1	The bounds of a rectangle specifying the location of the region, x_0, y_0, x_1, y_1 . See C.8.5.4.1.1 for further explanation.
>Physical Units X Direction	(0018,6024)	1	The physical units of the dimensions of the region. See C.8.5.4.1.2 for Enumerated Values.
>Physical Units Y Direction	(0018,6026)	1	The physical units of the dimensions of the region. See C.8.5.4.1.2 for Enumerated Values.
>Physical Delta X	(0018,602C)	1	The physical value increments per positive X pixel increment. The units are as specified in the physical units data element.
>Physical Delta Y	(0018,602E)	1	The physical value increments per positive Y pixel increment. The units are as specified in the physical units data element.
>Reference Pixel x_0	(0018,6020)	3	This coordinate pair, x_0, y_0 defines the location of a virtual "reference" pixel. See C.8.5.4.1.3 for further explanation.
>Reference Pixel y_0	(0018,6022)	3	This coordinate pair, x_0, y_0 defines the location of a virtual "reference" pixel. See C.8.5.4.1.3 for further explanation.
>Ref. Pixel Physical Value X	(0018,6028)	3	The Physical Value at the reference pixel x location. The units are specified in the Physical Units field.
>Ref. Pixel Physical Value Y	(0018,602A)	3	The Physical Value at the reference pixel y location. The units are specified in the Physical Units field.
>Region Spatial Format	(0018,6012)	1	The spatial organization of the data within the region. See C.8.5.5.1.1 for Enumerated Values.
>Region Data Type	(0018,6014)	1	The type of data within the region. See C.8.5.5.1.2 for Enumerated Values.
>Region Flags	(0018,6016)	1	Flags used for special handling of the region. See C.8.5.5.1.3 for Enumerated Values and further explanation.
>Pixel Component Organization	(0018,6044)	1C	Describes how the components of a pixel can be described. Required if pixel component calibration exists for this region. See C.8.5.5.1.4 for Enumerated Values and further explanation.

>Pixel Component Mask	(0018,6046)	1C	This value is ANDed with the composite pixel code for each pixel within the region, then shifted right by the number of contiguous least significant zeros in the mask to obtain what will be referred to as the "Shifted Masked Composite Pixel Code" (SMCPC). Required if Pixel Component Organization = Bit aligned. See C.8.5.5.1.5 for further explanation.
>Pixel Component Range Start	(0018,6048)	1C	Defines the start of the numeric range of values within the composite pixel where calibration is to be defined by the "pixel physical calibration table". To be used only when ranges are used to describe the portion of the composite pixel. Required if Pixel Component Organization = Ranges.
>Pixel Component Range Stop	(0018,604A)	1C	Defines the stop of the numeric range of values within the composite pixel where calibration is to be defined by the "pixel physical calibration table". To be used only when ranges are used to describe the portion of the composite pixel. Required if Pixel Component Organization = Ranges.
>Pixel Component Physical Units	(0018,604C)	1C	The physical units to be applied to the pixel component. Required if Pixel Component Organization exists. See C.8.5.5.1.6 for further explanation.
>Pixel Component Data Type	(0018,604E)	1C	The type of data for the pixel component. Required if Pixel Component Organization exists. See C.8.5.5.1.7 for further explanation.
>Number of Table Break Points	(0018,6050)	1C	The number of break point coordinate pairs used to describe a piece wise linear curve. Required if Pixel Component Organization equals 0 or 1. Otherwise not used. See C.8.5.5.1.8 for further explanation.
>Table of X Break Points	(0018,6052)	1C	An array of X values used to create the piece wise linear curve. Required if Pixel Component Organization equals 0 or 1. Otherwise not used. See C.8.5.5.1.9 for further explanation.

>Table of Y Break Points	(0018,6054)	1C	An array of Y values used to create the piece wise linear curve. Required if Pixel Component Organization equals 0 or 1. Otherwise not used. See C.8.5.5.1.9 for further explanation.
>Number of Table Entries	(0018,6056)	1C	The number of entries in the Table of Pixel Values. Required if the Pixel Component Organization equals 2. Otherwise not used. See C.8.5.5.1.11 for further explanation.
>Table of Pixel Values	(0018,6058)	1C	A table of Pixel Values used in conjunction with the Table of Parameter Values to provide a mapping from Pixel Value to Parameter Value. Required if the Pixel Component Organization equals 2. Otherwise not used. See C.8.5.5.1.12 for further explanation.
>Table of Parameter Values	(0018,605A)	1C	A table of Parameter Values used in conjunction with the Table of Pixel Values to provide a mapping from Pixel Value to Parameter Value. Required if the Pixel Component Organization equals 2. Otherwise not used. See C.8.5.5.1.13 for further explanation
>Tranducer Frequency	(0018,6030)	3	The manufacturer defined description of center frequency of the interrogating ultrasound energy. The units are kilohertz.
>Pulse Repetition Frequency	(0018,6032)	3	The ultrasound pulse repetition frequency, as defined by the manufacturer, used to collect data in the region. The units are in hertz.
>Doppler Correction Angle	(0018,6034)	3	The Doppler correction angle. The units are degrees.
>Steering Angle	(0018,6036)	3	The steering angle, as defined by the manufacturer, used for a steered 2D image. The units are degrees.
>Doppler Sample Volume X Position	(0018,6038)	3	The x displacement, in pixels, from the Reference pixel to the center of the Doppler sample volume.
>Doppler Sample Volume Y Position	(0018,603A)	3	The y displacement, in pixels, from the Reference pixel to the center of the Doppler sample volume.

>TM-Line Position x_0	(0018,603C)	3	The starting and ending coordinates pairs of the m-line. Where the X_0, Y_0 are the starting point and X_1, Y_1 are the end point of the tm-line. See C.8.5.5.1.10 for further explanation.
>TM-Line Position y_0	(0018,603E)	3	The starting and ending coordinates pairs of the m-line. Where the X_0, Y_0 are the starting point and X_1, Y_1 are the end point of the tm-line. See C.8.5.5.1.10 for further explanation.
>TM-Line Position x_1	(0018,6040)	3	The starting and ending coordinates pairs of the m-line. Where the X_0, Y_0 are the starting point and X_1, Y_1 are the end point of the tm-line. See C.8.5.5.1.10 for further explanation.
>TM-Line Position y_1	(0018,6042)	3	The starting and ending coordinates pairs of the m-line. Where the X_0, Y_0 are the starting point and X_1, Y_1 are the end point of the tm-line. See C.8.5.5.1.10 for further explanation.

C.8.5.5.1.1 Region Spatial Format

Enumerated Values for Region Spatial Format (0018,6012) indicate the spatial organization of the data within the region.

Value Meaning

0000H None or not applicable

0002H M-Mode(tissue or flow)

0004H Wave form(physiological traces, doppler traces,....)

Value Meaning

0001H 2D(tissue or flow)

0003H Spectral(CW or PW Doppler)

0005H Graphics

C.8.5.5.1.2 Region Data Type

Enumerated Values for Region Data Type (0018,6014) indicate the type of data within the region.

Value Meaning

0000H None or not applicable

0002H Color Flow

0004H CW Spectral Doppler

0006H Doppler Mode Trace

0008H Volume Trace

000AH ECG Trace

000CH Phonocardiogram Trace

Value Meaning

0001H Tissue

0003H PW Spectral Doppler

0005H Doppler Mean Trace

0007H Doppler Max Trace

0009H d(volume)/dt Trace

000BH Pulse Trace

000DH Gray bar

000EH	Color bar	000FH	Integrated Backscatter
0010H	Area Trace	0011H	$d(\text{area})/dt$
0012H	Other Physiological (Amplitude vs. Time) input		

C.8.5.5.1.3 Region Flags

Region Flags (0018,6016) are used for special handling of the region.

Enumerated Values for Bit 0 (lsb) Transparency:

1 = Transparent

0 = Opaque

If the region is transparent, then measurements may be done on regions underneath this region. This most useful for ECG overlays region overlapping with a 2D region.

Enumerated Values for Bit 1 Scaling Protection:

1 = Protected

0 = Not Protected

Ultrasound systems should set this to 1 if the image is scaled automatically by the ultrasound system. If the image is frame-grabbed and scaling is not available then it should be set to 0. If the region is protected, the region can not be manually rescaled. That is the data defined by the region calibration Module can not be overridden by a reader of that image.

Enumerated Values for Bit 2 Doppler Scale Type:

1 = Frequency

0 = Velocity

Valid for PW and CW regions only. Indicates which type of doppler scale is used.

Bit 3-31 Reserved for future use, shall be set to zero.

C.8.5.5.1.4 Pixel Component Organization

Pixel Component Organization (0018,6044) provides an Enumerated Value describing how the components of a pixel can be described. The absence of this data element means that pixel component calibration does not exist for this region. Where:

0 = Bit aligned positions

1 = Ranges

2 = Table look up

Other values reserved for future use.

C.8.5.5.1.5 Pixel Component Mask

Pixel Component Mask (0018,6046) is ANDed with the Composite Pixel Code (see Section C.7.6.3.1.1) for each pixel within the region, then shifted right by the number of contiguous least significant zeros in the mask to obtain what will be referred to as the "Shifted Masked Composite Pixel Code".

The mask will most likely (but not necessarily) contain a block of contiguous ones, surrounded by leading and trailing zeros. The purpose of this mask is to keep only those bits within the composite

pixel code which pertain to the region. It is to be used only when Pixel Organization is bit aligned positions.

C.8.5.5.1.6 Pixel Component Physical Units

For Pixel Component Physical Units (0018,604C), the Enumerated Values describing the physical units to be applied to the pixel component are:

Value	Meaning	Value	Meaning
0000H	None or not applicable	0001H	Percent
0002H	dB	0003H	cm
0004H	seconds	0005H	hertz(seconds ⁻¹)
0006H	dB/seconds	0007H	cm/sec
0008H	cm ²	0009H	cm ² /sec
000AH	cm ³	000BH	cm ³ /sec
000CH	degrees		

C.8.5.5.1.7 Pixel Component Data Type

For Pixel Component Data Type (0018,604E), the Enumerated Values indicating the type of data for the pixel component are:

Value	Meaning	Value	Meaning
0000H	None or not applicable	0001H	Tissue
0002H	Spectral doppler	0003H	Color Flow Velocity
0004H	Color Flow Variance	0005H	Color Flow Intensity
0006H	Gray bar	0007H	Color bar
0008H	Integrated Backscatter	0009H	Computed Border

C.8.5.5.1.8 Number of Table Break Points

The Number of Table Break Points (0018,6050) gives the number of entries in each of two tables: the Table of X Break Points (0018,6052) and Table of Y Break Points (0018,6054). These tables are used to designate a curve mapping the value of a pixel component to its actual physical value, as described in Section C.8.5.5.1.9.

C.8.5.5.1.9 Table of X Break Points and Table of Y Break Points

Table of X Break Points (0018,6052) and Table of Y Break Points (0018,6054) are individual arrays of coordinates which interpreted together are used to create a piecewise linear curve. Each X value from the Table of X Break Points is matched with the corresponding Y value from the Table of Y Break Points yielding an (X,Y) coordinate. The set of (X,Y) coordinates describes a piecewise linear curve mapping the value of a pixel component to its actual physical value (in units defined in Pixel Component Physical Units data element (0018,604C)).

The X direction on the curve has no units, and represents actual pixel component values. If the Pixel Component Organization (0018,6044) is "Bit aligned positions", and the width of the Pixel Component Mask is n bits then the X coordinates are in the range 0 through $2^n - 1$. If the Pixel

Component Organization is *Ranges*, then the X coordinates are in the range 0 through $2^{\text{number of bits in the composite pixel} - 1}$.

Note: The X value is NOT relative to the Pixel Component Range Start (0018,6048). Not all possible X values in the range need be covered by the curve.

For any pixel component value in the range of the curve described by this table, the corresponding Y value is the actual physical value for that pixel, in units specified in the Pixel Component Physical Units data element (0018,604C). If the pixel component value is NOT within the range of specified X values for the curve, then no pixel calibration is defined by this region. It may be possible for pixel calibration to be defined by other spatial regions underneath this one, if Region Flags (0018,6016) indicates this region is *Transparent*.

C.8.5.5.1.10 TM-Line Position X_0 , TM-Line Position Y_0 ,

TM-Line Position X_1 ,TM-Line Position Y_1

The TM-Line Position X_0 (0018,603C) and TM-Line Position Y_0 (0018,603E) are the coordinates of the starting point and TM-Line Position X_1 (0018,6040), TM-Line Position Y_1 (0018,6042) are the coordinates of the end point of the TM-line. The coordinate is defined as the displacement, in pixels, from the Reference pixel. Typically used for M-mode line and CW doppler.

C.8.5.5.1.11 Number of Table Entries

The Number of Table Entries (0018,6056) gives the number of entries in the Table of Pixel Values. The number of entries in the Table of Parameter Values is also equal to this number. Pixel Value and Parameter Value tables are used to assign Parameter values to pixels. A pixel is calibrated by finding an entry in the Pixel Value Table that matches its Composite Pixel Code (see Section C.7.6.3.1.1). The offset of this entry is used as an index into the Parameter Value Table. The Parameter value entry at this offset gives the Parameter Value of the Pixel.

Note: If a Composite Pixel Code has no matching value in the Pixel Value Table then there is no unambiguous way to determine the corresponding Parameter Value. A method may exist to determine a valid Parameter Value but the specification of such a method is outside the scope of the DICOM standard. No assumption should be made that linear interpolation will produce a valid result.

C.8.5.5.1.12 Table of Pixel Values

This is a table of unique Pixel Codes (0018,6058). The number of entries in the table is given by Number of Table Entries (0018,6056).

C.8.5.5.1.13 Table of Parameter Values

This is a table of parameter values (0018,605A). The number of table entries is given by Number of Table Entries and the physical units are given by Pixel Component Physical Units (0018,604C). Values may repeat when a parameter value is associated with more than one Composite Pixel Code value.

C.8.5.6 US Image Module

Table C.8-18 specifies the Attributes that describe ultrasound images.

**Table C.8-18
US IMAGE MODULE ATTRIBUTES**

Attribute Name	Tag	Type	Attribute Description
Samples Per Pixel	(0028,0002)	1	Number of samples (planes) in this image. See C.8.5.6.1.12 for specialization
Photometric Interpretation	(0028,0004)	1	Specifies the intended interpretation of the pixel data. See C.8.5.6.1.2 for specialization.
Bits Allocated	(0028,0100)	1	Number of bits allocated for each pixel sample. See C.8.5.6.1.13 for specialization.
Bits Stored	(0028,0101)	1	Number of bits stored for each pixel sample. See C.8.5.6.1.14 for specialization.
High Bit	(0028,0102)	1	Most significant bit for pixel sample data. See C.8.5.6.1.15 for specialization.
Planar Configuration	(0028,0006)	1C	Indicates whether the pixel data are sent color-by-plane or color-by-pixel. Required if Samples per Pixel (0028,0002) has a value greater than 1. See C.8.5.6.1.16 for specialization.
Pixel Representation	(0028,0103)	1	Data representation of pixel samples. See C.8.5.6.1.3 for specialization.
Frame Increment Pointer	(0028,0009)	1C	Contains the Data Element Tag of the attribute which is used as the frame increment in Multi-frame pixel data (see C.7.6.6). Required if Number of Frames is sent. See C.8.5.6.1.4 for specialization.
Image Type	(0008,0008)	2	Image identification characteristics. See C.8.5.6.1.1 for specialization.
Lossy Image Compression	(0028,2110)	1C	Specifies whether an Image has undergone lossy compression. Enumerated Values: 00 = Image has NOT been subjected to lossy compression. 01 = Image has been subjected to lossy compression. See C.7.6.1.1.5 Required if Lossy Compression has been performed on the Image.

Number of Stages	(0008,2124)	2C	Number of Stages in this protocol. Required if image was acquired in a Stage protocol.
Number of Views in Stage	(0008,212A)	2C	Number of views in this Stage. Required if image was acquired in a Stage protocol.
Ultrasound Color Data Present	(0028,0014)	3	This element indicates if any ultrasound color data is present in an image. Enumerated Values: 00 = Ultrasound color data not present in image 01 = Ultrasound color data is present in image. See C.8.5.6.10
Referenced Overlay Sequence	(0008,1130)	3	A Sequence which provides reference to a set of SOP Class/Instance pairs which are related independent Overlays. Uniquely identifies Overlays significantly related to this Image. Zero or more Items may be included in this Sequence.
>Referenced SOP Class UID	(0008,1150)	1C	Uniquely identifies the referenced SOP Class. Required if Referenced Overlay Sequence (0008,1130) is sent.
>Referenced SOP Instance UID	(0008,1155)	1C	Uniquely identifies the referenced SOP Instance. Required if Reference Overlay Sequence (0008,1130) is sent.
Referenced Curve Sequence	(0008,1145)	3	A sequence which provides reference to a set of SOP Class/Instance pairs which are related independent Curves. Uniquely identifies Curves significantly related to this Image.
>Referenced SOP Class UID	(0008,1150)	1C	Uniquely identifies the referenced SOP Class. Required if Referenced Curve Sequence (0008,1145) is sent.
>Referenced SOP Instance UID	(0008,1155)	1C	Uniquely identifies the referenced SOP Instance. Required if Reference Curve Sequence (0008,1145) is sent.
Referenced Waveform Sequence	(0008,113A)	3	References to waveforms acquired in conjunction with this image. These Waveforms may or may not be temporally synchronized with this image. One or more Items may be included in this Sequence.
<i>>Include 'SOP Instance Reference Macro' Table C.17-3</i>			
>Purpose of Reference Code Sequence	(0040,A170)	1	Code describing the purpose of the reference to the waveform(s). Only a single Item shall be permitted in this sequence.
<i>>>Include 'Code Sequence Macro' Table 8.8-1</i>		<i>Defined Context ID is CID 7004</i>	

Stage Name	(0008,2120)	3	A Stage is a particular time slice of a protocol in which a set of images are collected. The names can be free form text. Recommended text for Stress Echo stage names are: PRE-EXERCISE, POST-EXERCISE, PEAK-EXERCISE, RECOVERY, BASELINE, LOW DOSE, PEAK DOSE
Stage Code Sequence	(0040,000A)	3	Sequence of items describing the performed Ultrasound Protocol Stage(s).
<i>>Include "Code Sequence Macro" Table 8.8-1.</i>		<i>Baseline Context ID is 12002.</i>	
Stage Number	(0008,2122)	3	A number that identifies the Stage. Stage Number starts at one.
View Name	(0008,2127)	3	A View is a particular combination of the position and orientation when a set of images are acquired. Images are acquired at the same View in different Stages for the purpose of comparison.
View Number	(0008,2128)	3	A number that identifies the View. View Number starts at one.
Number of Event Timers	(0008,2129)	3	The number of event timers used at the time of acquisition of a Multi-frame image.
Event Elapsed Time(s)	(0008,2130)	3	An array of values associated with each event timer. Units in milliseconds.
Event Timer Name(s)	(0008,2132)	3	Name that identifies the event timer.
Anatomic Region Sequence	(0008,2218)	3	Sequence of one Item that identifies the anatomic region of interest in this image (i.e. external anatomy, surface anatomy, or general region of the body). See Section C.8.5.6.1.17.
<i>>Include 'Code Sequence Macro' Table 8.8-1</i>		<i>Baseline Context ID is 1 .</i>	
>Anatomic Region Modifier Sequence	(0008,2220)	3	Sequence of one or more Items that modifies the anatomic region of interest in this image (i.e. prone, supine, decubitus right). See Section C.8.5.6.1.17.
<i>>>Include 'Code Sequence Macro' Table 8.8-1</i>		<i>Baseline Context ID is 2 .</i>	
Primary Anatomic Structure Sequence	(0008,2228)	3	Sequence of one or more Items that identifies the primary anatomic structure of interest in this image. See Section C.8.5.6.1.18

<i>>Include 'Code Sequence Macro' Table 8.8-1</i>		<i>Baseline Context ID is 1 .</i>	
>Primary Anatomic Structure Modifier Sequence	(0008,2230)	3	Sequence of one or more Items that modifies the primary anatomic structure of interest in this image. See Section C.8.5.6.1.18
<i>>>Include 'Code Sequence Macro' Table 8.8-1</i>		<i>Baseline Context ID is 2 .</i>	
Transducer Position Sequence	(0008,2240)	3	Sequence of one or more Items that identifies the transducer position used in this image. See Section C.8.5.6.1.19.
<i>>Include 'Code Sequence Macro' Table 8.8-1</i>		<i>Baseline Context ID is 4 .</i>	
> Transducer Position Modifier Sequence	(0008,2242)	3	Sequence of one or more Items that modifies the primary transducer position of interest in this image. See Section C.8.5.6.1.19.
<i>>>Include 'Code Sequence Macro' Table 8.8-1</i>		<i>Baseline Context ID is 5 .</i>	
Transducer Orientation Sequence	(0008,2244)	3	Sequence of one or more Items that identifies the Transducer Orientation used in this image. See Section C.8.5.6.1.20.
<i>>Include 'Code Sequence Macro' Table 8.8-1</i>		<i>Baseline Context ID is 6 .</i>	
> Transducer Orientation Modifier Sequence	(0008,2246)	3	Sequence of one or more Items that modifies the primary Transducer Orientation of interest in this image. See Section C.8.5.6.1.20
<i>>>Include 'Code Sequence Macro' Table 8.8-1</i>		<i>Baseline Context ID is 7 .</i>	
Acquisition Datetime	(0008,002A)	1C	The date and time that the acquisition of data that resulted in this image started. Required if Modality (0008,0060) = IVUS May be present otherwise. Note: The synchronization of this time with an external clock is specified in the Synchronization Module in Acquisition Time Synchronized (0018,1800).
Trigger Time	(0018,1060)	3	Time interval measured in msec from the start of the R-wave to the beginning of data taking
Nominal Interval	(0018,1062)	3	Average R-R interval used for these data, in msec
Beat Rejection Flag	(0018,1080)	3	Beat length sorting has been applied. Enumerated Values: Y = yes N = no

Low R-R Value	(0018,1081)	3	R-R interval low limit for beat rejection, in msec
High R-R Value	(0018,1082)	3	R-R interval high limit for beat rejection, in msec
Heart Rate	(0018,1088)	3	Beats per minute.
IVUS Acquisition	(0018,3100)	1C	Defined Terms: MOTOR_PULLBACK MANUAL_PULLBACK SELECTIVE GATED_PULLBACK See C.8.5.6.1.21 Required if Modality (0008,0060) = IVUS
IVUS Pullback Rate	(0018,3101)	1C	Required if IVUS Acquisition (0018,3100) value is MOTOR_PULLBACK. Specified in units of mm/sec. See C.8.5.6.1.22
IVUS Gated Rate	(0018,3102)	1C	Required if IVUS Acquisition (0018,3100) value is GATED_PULLBACK. Specified in units of mm/beat. See C.8.5.6.1.23
IVUS Pullback Start Frame Number	(0018,3103)	1C	Required if IVUS Acquisition (0018,3100) value is MOTOR_PULLBACK or GATED_PULLBACK. See C.8.5.6.1.24
IVUS Pullback Stop Frame Number	(0018,3104)	1C	Required if IVUS Acquisition (0018,3100) value is MOTOR_PULLBACK or GATED_PULLBACK. See C.8.5.6.1.25
Lesion Number	(0018,3105)	3	Identifier(s) of the lesion(s) of interest imaged within the current SOP Instance. Each lesion shall have a unique numeric integer identifier within the study. See C.8.5.6.1.26.
Output Power	(0018,5000)	3	Manufacturer defined character string description of ultrasound output level(s) used in generating a given image. Data may be expressed in dB, %, W/cm ² , etc.
Transducer Data	(0018,5010)	3	Manufacturer defined code or description of ultrasound transducer used.

Transducer Type	(0018,6031)	3	Defined Terms: SECTOR_PHASED SECTOR_MECH SECTOR_ANNULAR LINEAR CURVED LINEAR SINGLE CRYSTAL SPLIT XTAL CWD IV_PHASED IV_ROT XTAL IV_ROT MIRROR ENDOCAP_PA ENDOCAP_MECH ENDOCAP_CLA ENDOCAP_AA ENDOCAP_LINEAR VECTOR_PHASED
Focus Depth	(0018,5012)	3	The depth, from the transducer face, of the manufacturer defined beam focus used for the image, in cm.
Preprocessing Function	(0018,5020)	3	Manufacturer defined description of processing of echo information. Data may include code or description of gain (initial, overall, TGC, dynamic range, etc.), preprocessing, postprocessing, Doppler processing parameters, e.g. cutoff filters, etc., as used in generating a given image.
Mechanical Index	(0018,5022)	3	See C.8.5.6.1.8 for Description.
Bone Thermal Index,	(0018,5024)	3	See C.8.5.6.1.8 for Description.
Cranial Thermal Index	(0018,5026)	3	See C.8.5.6.1.8 for Description.
Soft Tissue Thermal Index	(0018,5027)	3	See C.8.5.6.1.8 for Description.
Soft Tissue-focus Thermal Index	(0018,5028)	3	See C.8.5.6.1.8 for Description.
Soft Tissue-surface Thermal Index	(0018,5029)	3	See C.8.5.6.1.8 for Description.
Depth of Scan Field	(0018,5050)	3	The depth, in mm, from the transducer face to the deepest point included in the displayed image– the field of view.
Image Transformation Matrix	(0018,5210)	3	Transformation Matrix, as described in C.8.5.6.1.9. Used for spatially related images where the relationship includes rotations.
Image Translation Vector	(0018,5212)	3	Translation Vector as described in C.8.5.6.1.9. Used for spatially related images where the relationship includes translations.
Overlay Subtype	(60xx,0045)	3	Defined term which identifies the intended purpose of the ROI Overlay Type. See C.8.5.6.1.11 for specialization.

C.8.5.6.1 US Image Attribute Descriptions

C.8.5.6.1.1 Image Type

For US Images, Image Type (0008,0008) is specified to be Type 2. The Defined Terms for Value 3 are:

ABDOMINAL	BREAST	CHEST
ENDOCAVITARY	ENDORECTAL	ENDOVAGINAL
EPICARDIAL	FETAL HEART	GYNECOLOGY
INTRACARDIAC	INTRAOPERATIVE	INTRAVASCULAR
MUSCULOSKELETAL	NEONATAL HEAD	OBSTETRICAL
OPHTHALMIC	PEDIATRIC	PELVIC
RETROPERITONEAL	SCROTAL	SMALL PARTS
TEE	THYROID	TRANSCRANIAL
TTE	US BIOPSY	VASCULAR

Value 4 is constructed as a modality bit map to allow for a description of multi-modality displays. In using this bit map, the sum of the values of the various modalities will unambiguously determine the constituent modalities.

0001 = 2D Imaging	0002 = M-Mode	0004 = CW Doppler
0008 = PW Doppler	0010 = Color Doppler	0020 = Color M-Mode
0040 = 3D Rendering	0100 = Color Power Mode	

- Notes:
1. All Values are hexadecimal encoded as a CS. See PS 3.5.
 2. For example, Color Flow with CW spectral Doppler would have a value 4 = 0015. Note that no assumption should be made in Color Doppler or Color M-Mode regarding underlying B or M-Mode, respectively.

C.8.5.6.1.2 Photometric Interpretation

For US Images, Photometric Interpretation (0028,0004) is specified to use the following Defined Terms:

MONOCHROME2	PALETTE COLOR	RGB
<i>ARGB (retired)</i>	YBR_FULL	YBR_FULL_422
YBR_PARTIAL_422		

Note: It is recommended that future implementations should not use ARGB photometric interpretation.

See PS 3.5 for restrictions imposed by compressed Transfer Syntaxes.

C.8.5.6.1.3 Pixel Representation

For US Images, Pixel Representation (0028,0103) is specified to use the following Enumerated Value:

0000H = unsigned integer

C.8.5.6.1.4 Frame Increment Pointer

For US Multi-frame images, the Attribute Frame Increment Pointer (0028,0009) of the Multi-frame Module (see Section C.7.6.6) is specified by the following Defined Terms:

00181063 = sequencing by Frame Time (0018,1063)

00181065 = sequencing by Frame Time Vector (0018,1065)

C.8.5.6.1.5 Retired

C.8.5.6.1.6 Retired

C.8.5.6.1.7 Retired

C.8.5.6.1.8 Mechanical Index, Bone Thermal Index, Cranial Thermal Index, Soft Tissue Thermal Index

The thermal and/or mechanical indices, when made available by a manufacturer, are defined according to the *Standard for Real-Time Display of Thermal and Mechanical Acoustic Output Indices on Diagnostic Ultrasound Equipment*, a voluntary performance standard jointly published by AIUM and NEMA.

C.8.5.6.1.9 Image Transformation Matrix and Image Translation Vector

In spatially related US images it is necessary to be able to convert data from the (x', y', z') coordinate system of the echo plane into the (x, y, z) coordinate system of the frame of reference. It is assumed that the echo-plane is a right handed, orthogonal Cartesian coordinate system, with its origin at the Reference Pixel as defined in the US Frame Of Reference Module, such that +x' is directed to the right, +y' is directed toward the top of the screen, and +z' is directed out of the screen toward the viewer. From this definition z'≡ 0 everywhere on the echo plane. (x, y, z) is a similar right-handed system. The origin of (x', y', z') lies at the point (x₀, y₀, z₀) in the (x, y, z) system (**x₀** in vector notation). Once the appropriate translation has been applied, the two coordinate systems are related by a 3x3 rotation matrix **A**, such that a point **r'** in (x', y', z') may be converted to **r** in ((x, y, z) by a matrix multiplication and translation:

$$\mathbf{r} = \mathbf{A}\mathbf{r}' + \mathbf{x}_0.$$

These two operations may be combined in a single matrix multiplication by appending the translation vector to the rotation matrix:

$$\begin{bmatrix} a_{11} & a_{12} & a_{13} & x_0 \\ a_{21} & a_{22} & a_{23} & y_0 \\ a_{31} & a_{32} & a_{33} & z_0 \end{bmatrix} \begin{bmatrix} x' \\ y' \\ z' \\ 1 \end{bmatrix} = \begin{bmatrix} x \\ y \\ z \end{bmatrix}$$

Eq C.8-1

Where each a_{ij} represents the cosine of the angle between the ith unit vector of the (x', y', z') system and the jth unit vector of the (x, y, z) system, or i•j. These nine rotation components are not independent, but rather are constrained by the orthonormality condition to

$$\sum_{i=1}^3 a_{ij} a_{ik} = \mathbf{d}_{jk}$$

where d_{jk} is the Kronecker delta function, 0 for $j \neq k$, and 1 for $j=k$.

Taking advantage of the fact that $z' \equiv 0$, Eq. C.8-1 can be reduced to:

$$\begin{bmatrix} a_{11} & a_{12} & 0 & x_0 \\ a_{21} & a_{22} & 0 & y_0 \\ a_{31} & a_{32} & 0 & z_0 \end{bmatrix} \begin{bmatrix} x' \\ y' \\ 0 \\ 1 \end{bmatrix} = \begin{bmatrix} x \\ y \\ z \end{bmatrix}$$

Eq C.8-2

The Image Transformation Matrix (0018,5210) shall consist of the direction cosines in the following order:

$$a_{11}, a_{21}, a_{31}, a_{12}, a_{22}, a_{32}$$

The Image Translation Vector (0018,5212) shall consist of the translation elements from Eq C.8-2 in the following order:

$$x_0, y_0, z_0$$

The frame of reference (x, y, z) shall be defined by the first image in a spatially related series. Subsequent rotations of q about x (fan), y (propeller) or z (panorama) shall have the following Image Transformation Matrices:

$$\begin{array}{l} \text{FAN:} \begin{bmatrix} 1 & 0 \\ 0 & \cos q \\ 0 & \sin q \end{bmatrix} \end{array} \quad \begin{array}{l} \text{PROP:} \begin{bmatrix} \cos q & 0 \\ 0 & 1 \\ -\sin q & 0 \end{bmatrix} \end{array} \quad \begin{array}{l} \text{PAN:} \begin{bmatrix} \cos q & -\sin q \\ \sin q & \cos q \\ 0 & 0 \end{bmatrix} \end{array}$$

The convention used for rotation shall be positive when it appears counterclockwise when looking from the +x axis of rotation to the origin.

C.8.5.6.1.10 Ultrasound Color Data Present

Note: This data element can be used to indicate if an image contains any Ultrasound color data. For example: Some Ultrasound images may have a Photometric Interpretation equal to RGB but the image will have no color information if R=G=B for all pixels. For consistency within a particular implementation Monochrome Ultrasound images may be coded using a color photometric interpretation. In that case inclusion of this data element can significantly speed up processing. Since all components are known to be equal only one need be handled. The enhancements can be significant when compressed Transfer Syntaxes are used.

C.8.5.6.1.11 Overlay Subtype

For US Images, Overlay Subtype (60xx,0045) shall use the following Defined Terms:

ACTIVE 2D/BMODE IMAGE AREA = identification of the active area of a 2D/B-mode image.

C.8.5.6.1.12 Samples Per Pixel

For US Images, Samples Per Pixel (0028,0002) is specified to use the following values for specific Photometric Interpretations:

**Table C.8-19
US SAMPLES PER PIXEL**

Photometric Interpretation	Samples Per Pixel Value
MONOCHROME2	0001H
RGB	0003H
YBR_FULL	0003H
YBR_FULL_422	0003H
YBR_PARTIAL_422	0003H
PALETTE COLOR	0001H

C.8.5.6.1.13 Bits Allocated

For US Images, Bits Allocated (0028,0100) is specified to use the following values for specific Photometric Interpretations:

**Table C.8-20
US BITS ALLOCATED**

Photometric Interpretation	Bits Allocated Value
MONOCHROME2	0008H
RGB	0008H
YBR_FULL	0008H
YBR_FULL_422	0008H
YBR_PARTIAL_422	0008H
PALETTE COLOR	0008H - 8 bit palette, or 0010H - 16 bit palette

C.8.5.6.1.14 Bits Stored

For US Images, Bits Stored (0028,0101) is specified to use the following values for specific Photometric Interpretations:

**Table C.8-21
US BITS STORED**

Photometric Interpretation	Bits Stored Value
MONOCHROME2	0008H
RGB	0008H
YBR_FULL	0008H
YBR_FULL_422	0008H
YBR_PARTIAL_422	0008H
PALETTE COLOR	0008H - 8 bit palette, or 0010H - 16 bit palette

C.8.5.6.1.15 High Bit

For US Images, High Bit (0028,0102) is specified to use the following values for specific Photometric Interpretations:

**Table C.8-22
US HIGH BIT**

Photometric Interpretation	High Bit Value
MONOCHROME2	0007H
RGB	0007H
YBR_FULL	0007H
YBR_FULL_422	0007H
YBR_PARTIAL_422	0007H
PALETTE COLOR	0007H - 8 bit palette, or 000FH - 16 bit palette

C.8.5.6.1.16 Planar Configuration

For US Images, Planar Configuration (0028,0006) is specified to use the following values for specific Photometric Interpretations:

**Table C.8-23
US PLANAR CONFIGURATION**

Photometric Interpretation	Planar Configuration Value
RGB	0000H - color-by-pixel, or 0001H - color-by-plane
YBR_FULL	0001H
YBR_FULL_422	0000H
YBR_PARTIAL_422	0000H

C.8.5.6.1.17 Anatomic Region Sequence

The general region of the body (e.g. the anatomic region, organ, or body cavity being examined) may be identified by the Anatomic Region Sequence (0008,2218). Characteristics of the anatomic region being examined, such as its orientation relative to gravity (e.g. prone, supine, semi-erect), sub-region (e.g. medial, lateral, superior, inferior, lobe, quadrant), and laterality (e.g. right, left, both), and so on, may be refined by the Anatomic Region Modifier Sequence (0008,2220).

Note: These Attributes allow the specification of the information encoded by the Body Part Examined (0018,0015) and Patient Position (0018,5100) Attributes (in the General Series Module) in a more robust, consistent way.

C.8.5.6.1.18 Primary Anatomic Structure Sequence

The specific anatomic structures of interest within the image (e.g. a particular artery within the anatomic region) is identified by the Primary Anatomic Structure Sequence (0008,2228). Characteristics of the anatomic structure, such as its location (e.g. subcapsular, peripheral, central), configuration (e.g. distended, contracted), and laterality (e.g. right, left, both), and so on, may be refined by the Primary Anatomic Structure Modifier Sequence (0008,2230).

Notes: 1. These Attributes are intended to replace the Anatomic Structure (0008,2208) Attribute.
 2. The Defined Context ID for IVUS modality images is CID 3010 and CID 3014 (see PS3.16). For Primary Anatomic Structure Modifier Sequence the Defined Context ID for IVUS modality images is CID 3019 (see PS3.16).

C.8.5.6.1.19 Transducer Position Sequence

Note: These Attributes are intended to replace the Transducer Position (0008,2200) Attribute.

C.8.5.6.1.20 Transducer Orientation Sequence

Note: These Attributes are intended to replace the Transducer Orientation(0008,2204) Attribute.

C.8.5.6.1.21 IVUS Acquisition

This attribute denotes which of the following defined terms describes the method used to acquire the IVUS Images.

MOTOR_PULLBACK: The IVUS imaging catheter is positioned in the blood vessel under examination distal to the anatomical structures to be examined. Then the catheter is attached to a motorized mechanism capable of withdrawing the catheter through the vessel at a constant velocity specified by the attribute IVUS Pullback Rate (0018,3101) from the defined IVUS Pullback Start Frame Number (0018,3103) (see C.8.5.6.1.24) to the IVUS Pullback Stop Frame Number (0018,3104) (see C.8.5.6.1.25).

MANUAL_PULLBACK: The IVUS imaging catheter is positioned in the blood vessel under examination distal to the anatomical structures to be examined. Then the catheter is manually withdrawn through the vessel region of interest.

SELECTIVE: The IVUS imaging catheter is positioned in the blood vessel under examination near the anatomical structures to be examined. Then the catheter is manually withdrawn or advanced through the vessel region of interest.

GATED_PULLBACK: The IVUS imaging catheter is positioned in the blood vessel under examination distal to the anatomical structures to be examined. Then the catheter is attached to a motorized mechanism capable of withdrawing the catheter through the vessel at a rate specified by the attribute IVUS Gated Rate (0018,3102), once per heart

cycle, from the defined IVUS Pullback Start Frame Number (0018,3103) (see C.8.5.6.1.24) to the IVUS Pullback Stop Frame Number (0018,3104) (see C.8.5.6.1.25).

C.8.5.6.1.22 IVUS Pullback Rate

The attribute IVUS Pullback Rate (0018,3101) is required when IVUS Acquisition (0018,3100) is MOTOR_PULLBACK and it specifies the velocity of withdrawal of the IVUS imaging catheter in millimeters per second.

C.8.5.6.1.23 IVUS Gated Rate

The attribute IVUS Gated Rate (0018,3102) is required when IVUS Acquisition (0018,3100) is GATED_PULLBACK and it specifies the velocity of withdrawal of the IVUS imaging catheter in millimeters per beat.

C.8.5.6.1.24 IVUS Pullback Start Frame Number

The IVUS Pullback Start Frame Number (0018,3103) specifies the frame number of a IVUS multi-frame acquisition upon which motorized or gated pullback begins.

C.8.5.6.1.25 IVUS Pullback Stop Frame Number

The IVUS Pullback Stop Frame Number (0018,3104) specifies the frame number of a IVUS multi-frame acquisition upon which motorized or gated pullback ends.

C.8.5.6.1.26 Lesion Number

Attribute Lesion Number identifies the lesion(s) of interest imaged within the current SOP Instance. Each lesion shall have a unique numeric integer identifier within the study. If during a study the same lesion is imaged more than once, the same Lesion Number should be used for both SOP Instances.

- Notes:
- 1.Lesion Number is not a DICOM UID.
 - 2.An IVUS pullback may contain multiple values in Lesion Number.

C.8.6 Secondary Capture Modules

C.8.6.1 SC Equipment Module

This Module describes equipment used to convert images into a DICOM format.

Table C.8-24
SC IMAGE EQUIPMENT MODULE ATTRIBUTES

Attribute Name	Tag	Type	Attribute Description
Conversion Type	(0008,0064)	1	Describes the kind of image conversion. Defined Terms : DV = Digitized Video DI = Digital Interface DF = Digitized Film WSD = Workstation SD = Scanned Document SI = Scanned Image DRW = Drawing SYN = Synthetic Image
Modality	(0008,0060)	3	Source equipment for the image. This type definition shall override the definition in the General Series Module. See C.7.3.1.1.1 for Enumerated Values.
Secondary Capture Device ID	(0018,1010)	3	User defined identification of the device that converted the image
Secondary Capture Device Manufacturer	(0018,1016)	3	Manufacturer of the Secondary Capture Device
Secondary Capture Device Manufacturer's Model Name	(0018,1018)	3	Manufacturer's model number of the Secondary Capture Device
Secondary Capture Device Software Version	(0018,1019)	3	Manufacturer's designation of software version of the Secondary Capture Device
Video Image Format Acquired	(0018,1022)	3	Original format of the captured video image (e.g. NTSC, PAL, Videomed-H)
Digital Image Format Acquired	(0018,1023)	3	Additional information about digital interface used to acquire the image

Notes: 1. The Attributes specified in the General equipment Module (see Table C.7-6) describe the equipment which created the image being captured. The Attributes of the SC Equipment Module define the equipment that captured the image. The following table illustrates typical scenarios for different conversion types:

Conversion Type (0008,0064)	General Equipment	Secondary Capture Equipment
Digitized Video (DV)	The equipment generating the video signal.	The equipment digitizing the video signal.
Digital Interface (DI)	The equipment on the sending side of the digital interface.	The equipment on the receiving side of the digital interface.
Digitized Film (DF)	The equipment which created the film.	The equipment digitizing the film.
Workstation (WSD)	Application dependent, but often the equipment which placed the image on the workstation screen, or created the modified image.	The equipment which captured the image from the screen, or which placed the modified image into a DICOM SOP Instance.
Scanned Document (SD)	The equipment which created the document.	The equipment digitizing the document.
Scanned Image (SI)	The equipment which created the image that was digitized.	The equipment digitizing the image.
Drawing (DRW)	The equipment which created the drawing.	The equipment digitizing (or rasterizing) the drawing.
Synthetic Image (SYN)	The equipment creating the original images from which the synthetic image was derived.	The equipment creating the synthetic image.

2. The Attribute Modality (0008,0060) specified in the General Series Module (see Table C.7-4) has been specialized by this Module and is defined as a Type 3 Attribute.

C.8.6.2 SC Image Module

Table C.8-25 contains IOD Attributes that describe Secondary Capture Images.

Table C.8-25
SC IMAGE MODULE ATTRIBUTES

Attribute Name	Tag	Type	Attribute Description
Date of Secondary Capture	(0018,1012)	3	The date the Secondary Capture Image was captured.
Time of Secondary Capture	(0018,1014)	3	The time the Secondary Capture Image was captured.

Note: The Attributes specified in the General Image Module (see Table C.7-7) describe this image (ie. the secondary capture image). For example, Instance Number (0020,0013) is the image number of the secondary capture image. Source Image Sequence (0008,2112) may reference the DICOM image from which this image was generated.

C.8.6.3 SC Multi-frame Image Module

Table C.8-25b contains IOD Attributes that describe SC Multi-frame images.

Table C.8-25b
SC MULTI-FRAME IMAGE MODULE ATTRIBUTES

Burned In Annotation	(0028,0301)	1	<p>Indicates whether or not image contains sufficient burned in annotation to identify the patient and date the image was acquired.</p> <p>Enumerated Values:</p> <p>YES NO</p>
Presentation LUT Shape	(2050,0020)	1C	<p>Specifies an identity transformation for the Presentation LUT, such that the output of all grayscale transformations defined in the IOD containing this Module are defined to be P-Values.</p> <p>Enumerated Values:</p> <p>IDENTITY - output is in P-Values.</p> <p>Required if Photometric Interpretation (0028,0004) is MONOCHROME2, and BitsStored (0028,0101) is greater than 1.</p> <p>Note: If the VOI LUT Module is required by the IOD but no VOI LUT Sequence (0028,3010) or Window Center (0028,1050) is present, then the VOI LUT stage is an identity transformation.</p>
Illumination	(2010,015E)	3	<p>Luminance of a hypothetical viewing device illuminating a piece of monochrome transmissive film, or for the case of reflective media, luminance obtainable from diffuse reflection of the illumination present. Expressed as L_0, in candelas per square meter (cd/m^2).</p> <p>Note: May be used together with Reflected Ambient Light (2010,0160) to recover Optical Density information from P-Values. See C.8.6.3.1.</p>
Reflected Ambient Light	(2010,0160)	3	<p>For scanned monochrome transmissive film viewed on a hypothetical viewing device, the luminance contribution due to reflected ambient light. Expressed as L_a, in candelas per square meter (cd/m^2).</p> <p>Note: May be used together with Illumination (2010,015E) to recover Optical Density information from P-Values. See C.8.6.3.1.</p>

Rescale Intercept	(0028,1052)	1C	<p>The value b in the relationship between stored values (SV) in Pixel Data (7FE0,0010) and the output units specified in Rescale Type (0028,1054).</p> <p>Output units = $m \cdot SV + b$.</p> <p>Enumerated Value: 0</p> <p>Required if Photometric Interpretation (0028,0004) is MONOCHROME2, and BitsStored () is greater than 1.</p> <p>Note: This specifies an identity Modality LUT transformation.</p>
Rescale Slope	(0028,1053)	1C	<p>m in the equation specified by Rescale Intercept (0028,1052).</p> <p>Enumerated Value: 1</p> <p>Required if Photometric Interpretation (0028,0004) is MONOCHROME2, and BitsStored (0028,0101) is greater than 1.</p> <p>Note: This specifies an identity Modality LUT transformation.</p>
Rescale Type	(0028,1054)	1C	<p>Specifies the output units of Rescale Slope (0028,1053) and Rescale Intercept (0028,1052).</p> <p>Enumerated Value: US = Unspecified</p> <p>Required if Photometric Interpretation (0028,0004) is MONOCHROME2, and BitsStored (0028,0101) is greater than 1.</p> <p>Note: This specifies an identity Modality LUT transformation.</p>
Frame Increment Pointer	(0028,0009)	1C	<p>Contains the Data Element Tag of the attribute which is used as the frame increment in Multi-frame pixel data. See C.7.6.6.1.1 for further explanation.</p> <p>Shall be present if Number of Frames is greater than 1, overriding (specializing) the Type 1 requirement on this attribute in the Multi-frame Module.</p>

Nominal Scanned Pixel Spacing	(0018,2010)	1C	Physical distance on the media being digitized or scanned between the center of each pixel, specified by a numeric pair - adjacent row spacing (delimiter) adjacent column spacing in mm. Required if Conversion Type (0008,0064) is DF (Digitized Film). May also be present if Conversion Type (0008,0064) is SD (Scanned Document) or SI (Scanned Image). Shall be consistent with Pixel Aspect Ratio(0028,0034), if present.
Digitizing Device Transport Direction	(0018,2020)	3	Enumerated Values: ROW COLUMN
Rotation of Scanned Film	(0018,2030)	3	Angle of the edge of the film relative to the transport direction in degrees greater than or equal to -45 and less than or equal to +45.

C.8.6.3.1 Scanned Film, Optical Density and P-Values

Illumination (2010,015E) and Reflected Ambient Light (2010,0160) may be used to recover Optical Density information from P-Values.

Monochrome media that is being digitized is often measured in Optical Density values. These values need to be converted to P-Values for storage and display. The P-Values used in an image correspond to the perception of a human observer viewing the film on a hypothetical viewing device (such as a light box), using the specified values of Illumination (2010,015E) and Reflected Ambient Light (2010,0160).

The Grayscale Standard Display Function defined in PS 3.14 is used to convert Luminance to P-Values. In the case of scanned film, the Luminance is derived from Optical Density using the specified values of Illumination (2010,015E) and Reflected Ambient Light (2010,0160). An example of this derivation, as well as typical "default" values for these parameters, is specified in PS 3.14.

C.8.6.4 SC Multi-frame Vector Module

Table C.8-25c contains IOD Attributes that may be the target of the Frame Increment Pointer (0028,0009) for SC Multi-frame images.

Table C.8-25c
SC MULTI-FRAME VECTOR MODULE ATTRIBUTES

Attribute Name	Tag	Type	Attribute Description
Frame Time Vector	(0018,1065)	1C	An array which contains the real time increments (in msec) between frames for a Multi-frame image. See C.7.6.5.1.2 for further explanation. Required if Frame Increment Pointer (0028,0009) points to Frame Time Vector (0018,1065).

Page Number Vector	(0018,2001)	1C	An array which contains, for each of the image frames, the corresponding page numbers of the original document. Required if Frame Increment Pointer (0028,0009) points to Page Number Vector (0018,2001).
Frame Label Vector	(0018,2002)	1C	An array which contains, for each of the image frames, a descriptive label. Required if Frame Increment Pointer (0028,0009) points to Frame Label Vector (0018,2002).
Frame Primary Angle Vector	(0018,2003)	1C	An array which contains, for each of the image frames, the primary angle of rotation about an undefined axis, in degrees. May be used for annotative purposes for "cine loops" of 3D reprojected images Required if Frame Increment Pointer (0028,0009) points to Frame Primary Angle Vector (0018,2003).
Frame Secondary Angle Vector	(0018,2004)	1C	An array which contains, for each of the image frames, the secondary angle of rotation about an undefined axis that is orthogonal to that used for Frame Primary Angle Vector (0018,2003), in degrees. May be used for annotative purposes for "cine loops" of 3D reprojected images Required if Frame Increment Pointer (0028,0009) points to Frame Secondary Angle Vector (0018,2004).
Slice Location Vector	(0018,2005)	1C	Relative position of exposure expressed in mm, as defined for Slice Location (0020,1041). See C.7.6.2.1.2 for further explanation. Required if Frame Increment Pointer (0028,0009) points to Slice Location Vector (0018,2005).
Display Window Label Vector	(0018,2006)	1C	An array which contains, for each of the image frames, a label or number of the display window of a graphical user interface from which the frame was captured. Required if Frame Increment Pointer (0028,0009) points to Display Window Label Vector (0018,2006).

C.8.7 X-Ray Modules

This Section describes Modules used in one or more X-Ray IODs. These Modules contain Attributes that are specific to X-Ray images.

C.8.7.1 X-Ray Image Module

Table C.8-26
X-RAY IMAGE MODULE ATTRIBUTES

Attribute Name	Tag	Type	Attribute Description
Frame Increment Pointer	(0028,0009)	1C	Required if Multi-Frame Image. Contains the Data Element Tag of the attribute which is used as the Frame increment in Multi-frame image pixel data (See C.7.6.6). Specialized for X-Ray as Enumerated Value: 00181063H = Frame Time (0018,1063); 00181065H = Frame Time Vector (0018,1065).
Lossy Image Compression	(0028,2110)	1C	Specifies whether an Image has undergone lossy compression. Enumerated Values: 00 = Image has NOT been subjected to lossy compression. 01 = Image has been subjected to lossy compression. See C.7.6.1.1.5 Required if Lossy Compression has been performed on the Image.
Image Type	(0008,0008)	1	Image identification characteristics. See C.8.7.1.1.1 for specialization.
Pixel Intensity Relationship	(0028,1040)	1	The relationship between the Pixel sample values and the X-Ray beam intensity. See Section C.8.7.1.1.2.
Samples per Pixel	(0028,0002)	1	Number of samples (color planes) in this image shall have a value of 1.
Photometric Interpretation	(0028,0004)	1	Specifies the intended interpretation of the pixel data. Only MONOCHROME2 may be used.
Bits Allocated	(0028,0100)	1	Number of bits allocated for each pixel sample. See Section C.8.7.1.1.6.
Bits Stored	(0028,0101)	1	Number of bits stored for each pixel sample. See Section C.8.7.1.1.7.
High Bit	(0028,0102)	1	Most significant bit for pixel sample data. See Section C.8.7.1.1.8.

Pixel Representation	(0028, 0103)	1	Data representation of the pixel samples. Shall have the value: 0000H = Unsigned Integer.
Scan Options	(0018,0022)	3	Parameters of scanning sequence. See Section C. 8.7.1.1.4.
Anatomic Region Sequence	(0008,2218)	3	Sequence of one Item that identifies the anatomic region of interest in this image (i.e. external anatomy, surface anatomy, or general region of the body). This anatomic region is placed on the table for examination. See C.8.7.1.1.10.
<i>>Include 'Code Sequence Macro' Table 8.8-1</i>		<i>Baseline Context ID is 1 .</i>	
>Anatomic Region Modifier Sequence	(0008,2220)	3	Sequence of one or more Items that modifies the anatomic region of interest in this image (i.e. prone, supine, decubitus right). May be present only if Anatomic Region Sequence (0008,2218) is sent. See C.8.7.1.1.10.
<i>>>Include 'Code Sequence Macro' Table 8.8-1</i>		<i>Baseline Context ID is 2 .</i>	
Primary Anatomic Structure Sequence	(0008,2228)	3	Sequence of one or more Items that identifies the primary anatomic structure of interest in this image. See C.8.7.1.1.11.
<i>>Include 'Code Sequence Macro' Table 8.8-1</i>		<i>Baseline Context ID is 1 .</i>	
>Primary Anatomic Structure Modifier Sequence	(0008,2230)	3	Sequence of one or more Items that modifies the primary anatomic structure of interest in this image. May be present only if Primary Anatomic Structure Sequence (0008,2228) is sent. See C.8.7.1.1.11.
<i>>>Include 'Code Sequence Macro' Table 8.8-1</i>		<i>Baseline Context ID is 2 .</i>	
R Wave Pointer	(0028,6040)	3	Marks the location(s) of the R Wave in the cardiac cycles by referencing frame numbers; frame numbers begin with 1.
Reference Image Sequence	(0008,1140)	1C	A sequence which provides reference to a set of Image SOP Class/Instance identifying other images significantly related to this image. Shall be used to relate each plane to the corresponding plane if Image Type (0008,0008) Value 3 is BIPLANE A or BIPLANE B. When relating to the corresponding plane of a Biplane acquisition, only a single item shall be present.

> Reference SOP Class UID	(0008,1150)	1C	Uniquely identifies the referenced SOP Class. Required if Referenced Image Sequence (0008,1140) is present.
> Reference SOP Instance UID	(0008,1155)	1C	Uniquely identifies the referenced SOP Instance. Required if Referenced Image Sequence (0008,1140) is present.
Derivation Description	(0008,2111)	3	A text description of how this image was derived. See C.8.7.1.1.5 for further explanation.
Acquisition Device Processing Description	(0018,1400)	3	Indicates any visual processing performed on the images prior to exchange. See Section C.8.7.1.1.3.
Calibration Image	(0050,0004)	3	Indicates whether a reference object (phantom) of known size is present in the image and was used for calibration. Enumerated Values: YES NO Device is identified using the Device module. See C.7.6.12.

C.8.7.1.1 X-Ray Image Attribute Descriptions

C.8.7.1.1.1 Image Type

The Image Type attribute identifies important image characteristics in a multiple valued data element. For X-Ray, Image Type is specialized as follows:

- a. Value 1 shall identify the Pixel Data Characteristics in accordance with Section C.7.6.1.1.2; Enumerated Values are: ORIGINAL and DERIVED;
- b. Value 2 shall identify the Patient Examination Characteristics in accordance with Section C.7.6.1.1.2; Enumerated Values are: PRIMARY and SECONDARY.

Note: X-Ray images generally use PRIMARY value for images captured from patient exposure.

- c. Value 3 shall identify the image set in terms of the imaging planes. Enumerated Values are:

SINGLE PLANE Image is a single plane acquisition;

BIPLANE A Image is the first plane (e.g., Frontal) of a Bi-plane acquisition;

BIPLANE B Image is the second plane (e.g., Lateral) of a Bi-plane acquisition

- d. Other Values are implementation specific (optional).

C.8.7.1.1.2 Pixel Intensity Relationship

Pixel Intensity Relationship (0028,1040) shall identify the relationship of the pixel values to the X-Ray beam intensity. Defined terms are:

LIN	Approximately proportional to X-Ray beam intensity;
LOG	Non-linear “ Log Function”; A Modality LUT shall be included with the image to allow it to be scaled back to its proportional value to X-Ray beam intensity;
DISP	Ready to be displayed; A Modality LUT may be included with the image to allow it to be scaled back to its proportional value to X-Ray beam intensity. The Attribute Acquisition Device Processing Description may be used to provide some indication on the pre-processing performed to create the ready to be displayed image.

C.8.7.1.1.3 Acquisition Device Processing Description

Acquisition Device Processing Description (0018,1400) provides some indication in human readable text of the digital processing on the images before exchange. Examples of this processing are: edge enhanced, subtracted, time filtered, gamma corrected, convolved (spatially filtered).

C.8.7.1.1.4 Scan Options

The Scan Options attribute identifies any acquisition technique which was used during the acquisition of the image. Defined Terms are:

EKG	EKG Event Trigger
PHY	Physiological Event Trigger
TOMO	Tomography
CHASE	Bolus Chasing
STEP	Stepping
ROTA	Rotation

C.8.7.1.1.5 Derivation Description

If an Image is identified to be a Derived image (see C.8.9.1.1.1 Image Type), Derivation Description (0008,2111) is an optional and implementation specific text description of the way the image was derived from an original image. As applied to X-Ray images, it may be used to describe derivation operations such as edge enhancement, temporal filtering, digital subtraction, or other linear and non-linear transformations.

C.8.7.1.1.6 Bits Allocated

For X-Ray Images, Bits Allocated (0028,0100) shall have the Enumerated Value of 8 or 16.

C.8.7.1.1.7 Bits Stored

For X-Ray Images, Bits Stored (0028,0101) shall have the Enumerated Values of 8, 10, 12, or 16.

C.8.7.1.1.8 High Bit

For X-Ray Images, High Bit (0028,0102) shall have the Enumerated Value of one less than the value in Bit Stored.

C.8.7.1.1.9 Synchronization of Frame and Curve Times

If a Curve is present and of type ECG, pressure, physiological, respiration, time activity curve, the origin of the coordinate start time (50xx, 0112) shall be the time of frame 1.

C.8.7.1.1.10 Anatomic Region

The general region of the body (e.g. the anatomic region, organ, or body cavity being examined) may be identified by the Anatomic Region Sequence (0008,2218). Characteristics of the anatomic region being examined, such as its orientation relative to gravity (e.g. prone, supine, semi-erect), sub-region (e.g. medial, lateral, superior, inferior, lobe, quadrant), and laterality (e.g. right, left, both), and so on, may be refined by the Anatomic Region Modifier Sequence (0008,2220). These sequences utilize coded entry data to reference anatomic and modifier terms from a Coding Scheme (e.g. SNOMED).

Note: These Attributes allow the specification of the information encoded by the Body Part Examined (0018,0015) and Patient Position (0018,5100) Attributes (in the General Series Module) in a more robust, consistent way.

C.8.7.1.1.11 Primary Anatomic Structure

The specific anatomic structures of interest within the image (e.g. a particular artery within the anatomic region) is identified by the Primary Anatomic Structure Sequence (0008,2228). Characteristics of the anatomic structure, such as its location (e.g. subcapsular, peripheral, central), configuration (e.g. distended, contracted), and laterality (e.g. right, left, both), and so on, may be refined by the Primary Anatomic Structure Modifier Sequence (0008,2230). These sequences utilize coded entry data to reference anatomic and modifier terms from a Coding Scheme (e.g. SNOMED).

Note: These Attributes are intended to replace the Anatomic Structure (0008,2208) Attribute.

C.8.7.2 X-Ray Acquisition Module

**Table C.8-27
X-RAY ACQUISITION MODULE ATTRIBUTES**

Attribute Name	Tag	Type	Attribute Description
KVP	(0018,0060)	2	Peak kilo voltage output of the X-Ray generator used.
Radiation Setting	(0018,1155)	1	Identify the general level of X-Ray dose exposure. Enumerated values are: SC = low dose exposure generally corresponding to fluoroscopic settings (e.g. preparation for diagnostic quality image acquisition); GR = high dose for diagnostic quality image acquisition (also called digital spot or cine);
X-Ray Tube Current	(0018,1151)	2C	X-Ray Tube Current in mA. Required if Exposure (0018,1152) is not present.

Exposure Time	(0018,1150)	2C	Duration of X-Ray exposure in msec. See 8.7.2.1.1. Required if Exposure (0018,1152) is not present.
Exposure	(0018,1152)	2C	The exposure expressed in mAs, for example calculated from Exposure Time and X-ray Tube Current. Required if either Exposure Time (0018,1150) or X-Ray Tube Current (0018,1151) are not present.
Exposure in μ As	(0018,1153)	3	The exposure expressed in μ As, for example calculated from Exposure Time and X-ray Tube Current.
Grid	(0018,1166)	3	Identify the grid. Only a single value shall be present. Defined Terms are: IN = A Grid is positioned; NONE = No Grid is used.
Average Pulse Width	(0018,1154)	3	Average width of X-Ray pulse in msec.
Radiation Mode	(0018,115A)	3	Specifies X-Ray radiation mode. Defined Terms: CONTINUOUS PULSED
Type of Filters	(0018,1161)	3	Type of filter(s) inserted into the X-Ray beam (e.g. wedges).
Intensifier Size	(0018,1162)	3	Diameter of X-Ray intensifier in mm
Field of View Shape	(0018,1147)	3	Shape of the Image Intensifier Field of View. See C.8.7.2.1.2. Defined Terms are: ROUND RECTANGLE
Field of View Dimension(s)	(0018,1149)	3	Dimensions of the Image Intensifier Field of View in mm. If Rectangle, row dimension followed by column; if Round, diameter.
Imager Pixel Spacing	(0018,1164)	3	Physical distance measured at the front plane of the Image Receptor housing between the center of each pixel specified by a numeric pair - row spacing value(delimiter) column spacing value in mm.
Focal Spot	(0018,1190)	3	Nominal focal spot size in mm used to acquire this image.

Image Area Dose Product	(0018,115E)	3	<p>X-Ray dose, measured in $\text{dGy} \cdot \text{cm}^2$, to which the patient was exposed for the acquisition of this image plus any non-digitally recorded fluoroscopy which may have been performed to prepare for the acquisition of this image.</p> <p>Note: The sum of the Image Area Dose Product of all images of a Series or a Study may not result in the actual area dose product to which the patient was exposed.</p>
-------------------------	-------------	---	--

C.8.7.2.1 X-Ray Acquisition Attribute Descriptions

C.8.7.2.1.1 Exposure Time

Exposure time is the cumulative time the patient received X-Ray exposure during this image (Multi-frame image acquisition). Calculation is pulse width * number of frames.

C.8.7.2.1.2 Field of View

The Field of View Attribute describes the shape and dimensions of the Image Intensifier Field of View (zoom mode). This could be further restricted by the Collimator. See Section C.8.7.3.

C.8.7.3 X-Ray Collimator

An X-Ray Collimator is a device placed close to the X-Ray Source to restrict the span of the X-Ray beam. It is often made of lead shutters. Figure C.8-1 presents in a graphical form its relationship with the Field Of View Dimensions (0018,1149).

Geometry of the collimator is specified with respect to a row and column coordinate system where the origin is the upper left hand pixel. This origin is specified by the values 1,1 for row/column. A row coordinate represent a number of row spacing (vertical) and a column coordinate represents a column spacing (horizontal). Up to three different collimator shapes may be used and superimposed.

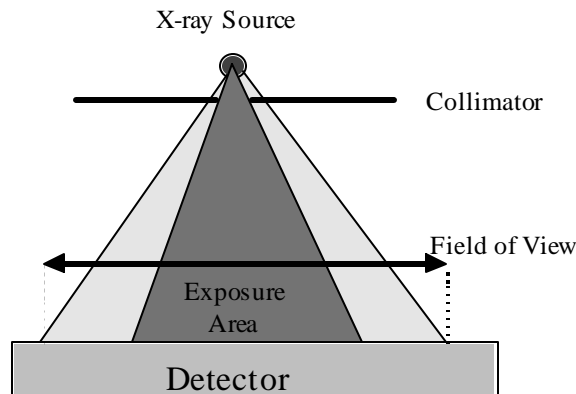

**Figure C.8-1
Relationships of X-Ray Collimator**

Table C.8-28
X-RAY COLLIMATOR MODULE ATTRIBUTES

Attribute Name	Tag	Type	Attribute Description
Collimator Shape	(0018,1700)	1	Shape(s) of the collimator. Enumerated Values: RECTANGULAR CIRCULAR POLYGONAL This multi-valued Attribute shall contain at most one of each Enumerated Value.
Collimator Left Vertical Edge	(0018,1702)	1C	Required if Collimator Shape (0018,1700) is RECTANGULAR. Location of the left edge of the rectangular collimator with respect to pixels in the image given as column. See C.8.7.3.1.1.
Collimator Right Vertical Edge	(0018,1704)	1C	Required if Collimator Shape (0018,1700) is RECTANGULAR. Location of the right edge of the rectangular collimator with respect to pixels in the image given as column. See C.8.7.3.1.1.
Collimator Upper Horizontal Edge	(0018,1706)	1C	Required if Collimator Shape (0018,1700) is RECTANGULAR. Location of the upper edge of the rectangular collimator with respect to pixels in the image given as row. See C.8.7.3.1.1.
Collimator Lower Horizontal Edge	(0018,1708)	1C	Required if Collimator Shape (0018,1700) is RECTANGULAR. Location of the lower edge of the rectangular collimator with respect to pixels in the image given as row. See C.8.7.3.1.1.
Center of Circular Collimator	(0018,1710)	1C	Required if Collimator Shape (0018,1700) is CIRCULAR. Location of the center of the circular collimator with respect to pixels in the image given as row and column. See C.8.7.3.1.1.
Radius of Circular Collimator	(0018,1712)	1C	Required if Collimator Shape (0018,1700) is CIRCULAR. Radius of the circular collimator with respect to pixels in the image given as a number of pixels along the row direction. See C.8.7.3.1.1.

Vertices of the Polygonal Collimator	(0018,1720)	1C	<p>Required if Collimator Shape (0018,1700) is POLYGONAL.</p> <p>Multiple Values where the first set of two values are:</p> <p style="padding-left: 40px;">row of the origin vertex; column of the origin vertex.</p> <p>Two or more pairs of values follow and are the row and column coordinates of the other vertices of the polygon collimator. Polygon collimators are implicitly closed from the last vertex to the origin vertex and all edges shall be non-intersecting except at the vertices.</p>
--------------------------------------	-------------	----	---

C.8.7.3.1 X-Ray Collimator Attribute Descriptions

C.8.7.3.1.1 Collimator Vertical and Horizontal Edges

These attributes specify the pixel row or column where the X-ray beam is fully obscured by a rectangular collimator:

- if the left edge of the collimator is not visible, Collimator Left Vertical Edge (0018,1702) shall have a value of 0;
- if the right edge of the collimator is not visible, Collimator Right Vertical Edge (0018,1704) value shall be 1 greater than the value of the Columns (0028,0011) attribute;
- if the top edge of the collimator is not visible, Collimator Upper Horizontal Edge (0018,1706) shall have a value of 0;
- if the bottom edge of the collimator is not visible, Collimator Lower Horizontal Edge (0018,1708) value shall be 1 greater than the value of the Rows (0028,0010) attribute.

C.8.7.4 X-Ray Table Module

Table C.8-29 contains Attributes that describe X-Ray images acquired with movement of the patient imaging table.

**Table C.8-29
X-RAY TABLE MODULE ATTRIBUTES**

Attribute Name	Tag	Type	Attribute Description
Table Motion	(0018,1134)	2	Defined terms: STATIC DYNAMIC
Table Vertical Increment	(0018,1135)	2C	Incremental change in Vertical position of the table relative to first frame of Multi-frame image given in mm. Required if Table Motion is DYNAMIC.

Table Longitudinal Increment	(0018,1137)	2C	Incremental change in Longitudinal position of the table relative to first frame of Multi-frame image in mm. Table motion towards LAO is positive. Required if Table Motion is DYNAMIC.
Table Lateral Increment	(0018,1136)	2C	Incremental change in Lateral position of the table relative to first frame of Multi-frame image given in mm. Table motion towards CRA is positive. Required if Table Motion is DYNAMIC.
Table Angle	(0018,1138)	3	Angle of table plane in degrees relative to horizontal plane [Gravity plane]. Positive values indicate that the head of the table is upwards.

C.8.7.4.1 X-Ray Table Attribute Descriptions

C.8.7.4.1.1 Table Motion Increments

The table moves the Patient with respect to the imaging chain. This is being tracked as a motion of the imaging chain with respect to a coordinate system attached to the patient (assumption is that the patient does not move with respect to the table). The coordinate system origin is fixed with respect to the patient at the time of the first frame. The X-axis is increasing to the left hand side of the patient. The y-axis is increasing to the posterior side of the patient. The Z-axis is increasing toward the head of the patient. The X and Z axis as drawn in Figure C.8-2 are parallel to the Patient Plane.

Note: Table motion causes the apparent locus of imaging to move in the opposite direction. For instance, with table motion towards LAO, the area of the patient imaged moves toward RAO.

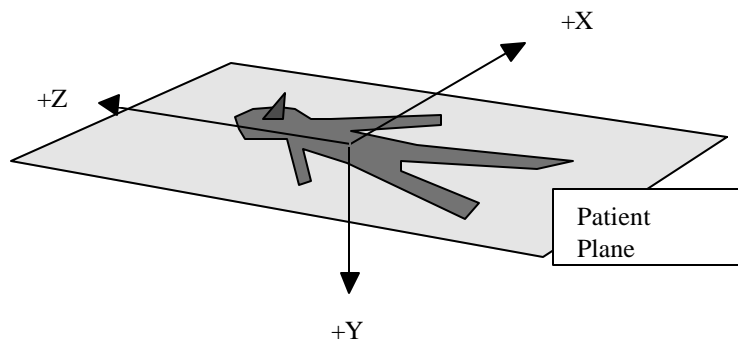

Figure C.8-2
Table Motion Vector Coordinates

C.8.7.5 XA Positioner Module

Table C.8-30 contains IOD Attributes that describe a c-arm positioner typically used in acquiring X-Ray Angiographic Images. The coordinate system used to track the positioner is defined in reference to the patient. The definition of coordinates with respect to the equipment is not supported. Furthermore, this module does not describe the movement of the Patient.

Note: The scope of the XA IOD is to address images produced on acquisition equipment equipped with an X-Ray source and an image Receptor positioned by what is general called a c-arm. For clinical areas other than Angiography which are using a c-arm to position the X-Ray source and image receptor (e.g. Interventional Procedures and Myelography and Biopsy/Localization), the X-Ray Angiography Image Object should be also used. Although the object is optimized for c-arm systems, it may also be used by other systems which support a similar coordinate system, such as some RF systems.

Table C.8-30
XA POSITIONER MODULE ATTRIBUTES

Attribute Name	Tag	Type	Attribute Description
Distance Source to Patient	(0018,1111)	3	Distance in mm from source to isocenter (center of field of view).
Distance Source to Detector	(0018,1110)	3	Distance in mm from source to detector center.
Estimated Radiographic Magnification Factor	(0018,1114)	3	Ratio of Source Image Distance (SID) over Source Object Distance (SOD).
Positioner Motion	(0018,1500)	2C	Used to describe the activity of the imaging devices. Defined terms: DYNAMIC, STATIC. Required if Multi-frame data. See C.8.7.5.1.1.
Positioner Primary Angle	(0018,1510)	2	Position of the X-Ray Image Intensifier about the patient from the RAO to LAO direction where movement from RAO to vertical is positive. See C.8.7.5.1.2.
Positioner Secondary Angle	(0018,1511)	2	Position of the X-Ray Image Intensifier about the patient from the CAU to CRA direction where movement from CAU to vertical is positive. See C.8.7.5.1.2
Positioner Primary Angle Increment	(0018,1520)	2C	Incremental change in primary positioner angle for each frame. See C.8.7.5.1.3. Required if Positioner Motion is DYNAMIC.
Positioner Secondary Angle Increment	(0018,1521)	2C	Incremental change in secondary positioner angle for each frame. See C.8.7.5.1.3. Required if Positioner Motion is DYNAMIC.

Detector Primary Angle	(0018,1530)	3	Angle of the X-Ray beam in the row direction in degrees relative to the normal to the detector plane. Positive values indicate that the X-Ray beam is tilted towards higher numbered columns. Negative values indicate that the X-Ray beam is tilted towards lower numbered columns. See C.8.7.5.1.4.
Detector Secondary Angle	(0018,1531)	3	Angle of the X-Ray beam in the column direction in degrees relative to the normal to the detector plane. Positive values indicate that the X-Ray beam is tilted towards lower numbered rows. Negative values indicate that the X-Ray beam is tilted towards higher numbered rows. See C.8.7.5.1.4.

C.8.7.5.1 XA Positioner Attribute Descriptions

C.8.7.5.1.1 Positioner Motion

Positioner Motion attribute is STATIC if the imaging table moves during a multi-frame acquisition, but the X-Ray positioner do not move.

Note: If the positioner undergoes translation (non-rotational movement) during the acquisition, then that motion shall be described by an opposite table motion (See Section C.8.7.4).

C.8.7.5.1.2 Positioner Primary and Secondary Angles

The definitions of Positioner Angles shall be with respect to the patient as illustrated in Figures C.8-3 and C.8-4. Zero degree is referenced to the origin perpendicular to the patient's chest. The Positioner Primary Angle definition is like longitude (in the equatorial plan); the Positioner Secondary Angle definition is like latitude (in the sagittal plane). The Positioner Angle attributes apply to the first frame of a multi-frame image. The valid range of Primary Positioner Angle is -180 to +180 degrees and the Secondary Positioner Angle range is -90 to + 90 degrees.

The Patient Plane is defined by the isocenter of the imaging device and slices through the patient such that it is perpendicular to the sagittal plane of the body. The Primary Axis of rotation is defined at the intersection of the Patient Plane and of the Sagittal Plane. The Positioner Primary Angle is defined in the transaxial plane at the isocenter with zero degrees in the direction perpendicular to the patient's chest and + 90 degrees at the Patient left hand side (LAO) and -90 at the Patient right hand side (RAO). The valid range of Primary Positioner Angle is -180 to +180 degrees.

The Secondary Axis is in the Patient Plane and is perpendicular to the Primary Axis at the isocenter. The Positioner Secondary Angle is defined in the Sagittal Plane at the isocenter with zero degrees in the direction perpendicular to the patient's chest. +90 degrees corresponds to the cranial direction. The Secondary Positioner Angle range is -90 to + 90 degrees.

At a 0 angle for both the Primary Angle (0018,1510) and Secondary Angle (0018,1511), the patient faces the Image Intensifier.

The Positioner Primary Angle (0018,1510) and Secondary Angle (0018,1511) apply to the first frame of a multi-frame image.

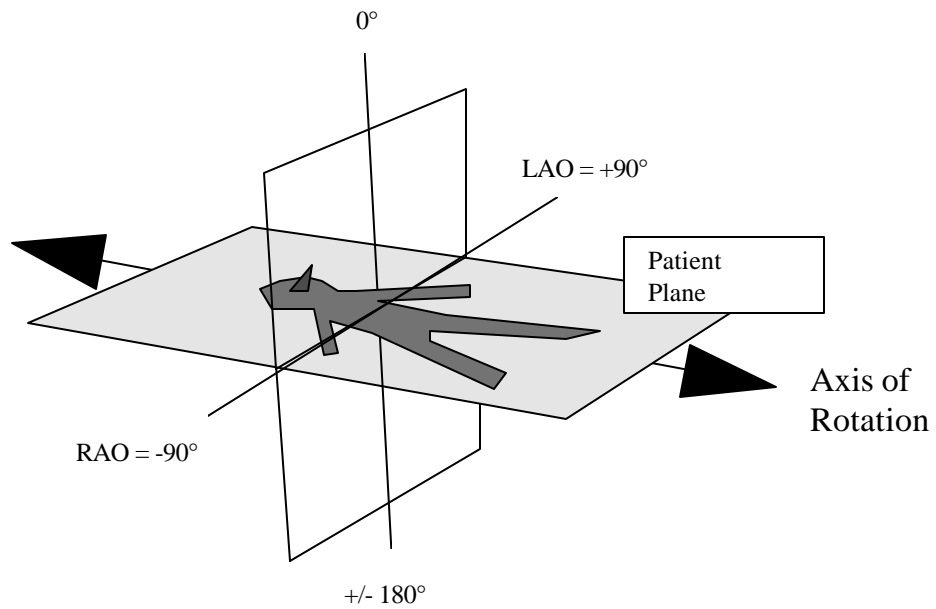

Figure C.8-3
Positioner Primary Angle

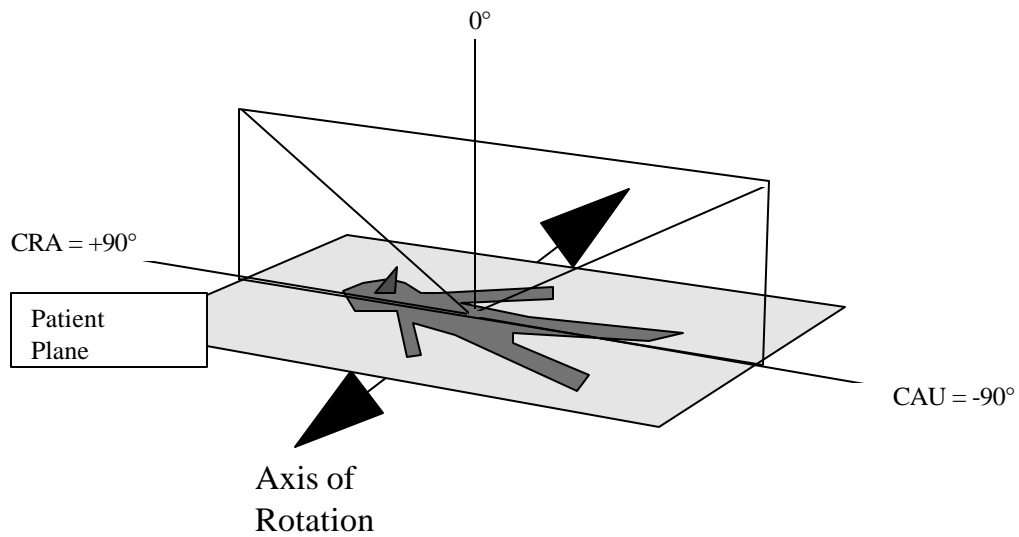

Figure C.8-4
Positioner Secondary Angle

C.8.7.5.1.3 Positioner Angle Increments

If the positioner angles change during acquisition of a multi-frame image, the Positioner Angle Increment attributes describe the angular change per frame.

If the change in positioner angle is nominally constant for each frame, these fields may contain a single value of the average angular change per frame. Alternatively, the fields may contain a vector of offsets from the (initial) Positioner Angle attributes, with one value for each frame in the multi-frame image. The number of values in the Positioner Angle Increment attributes must be one, or must be equal to the Number of Frames attribute (0028,0008) in the Multi-Frame Module (see Section C.7.6.6).

Note: It is permissible to generate a vector of the absolute positioner angles in the Positioner Angle Increment attributes, and set the Positioner Primary and Secondary Angle attributes to value 0.

C.8.7.5.1.4 Detector Primary and Secondary Angles

Detector Angles are defined in a fashion similar to the positioner angles, except that the angle of the central x-ray beam vector is relative to the detector plane rather than the patient plane. The central x-ray beam vector is defined as the vector from the x-ray source through the isocenter to the detector plane. Zero degree is referenced to the normal to the detector plane pointing away from the x-ray source. The Detector Angle attributes apply to the first frame of a multi-frame image. The valid range of the Detector Angles is -90 to + 90 degrees.

The Primary Axis of rotation is defined along the line in the column direction of the detector plane which intersects the central x-ray beam vector. The Detector Primary Angle is defined in the plane perpendicular to the Primary Axis of rotation at the point where the central x-ray beam vector intersects the detector plane, with zero degrees in the direction normal to the detector plane and - 90 degrees at the left hand side of the image (i.e., toward column 1) and +90 at the right hand side of the image (i.e., toward the highest numbered column). The valid range of Primary Detector Angle is -90 to +90 degrees.

The Secondary Axis is in the detector plane and is perpendicular to the Primary Axis at the intersection of the beam vector with the detector plane (i.e., it is along the row direction). The Detector Secondary Angle is defined in the plane perpendicular to the Secondary Axis at the point where the central x-ray beam vector intersects the detector plane, with zero degrees in the direction normal to the detector plane. +90 degrees corresponds to the direction toward the top of the image. The Secondary Detector Angle range is -90 to + 90 degrees.

C.8.7.6 XRF Positioner Module

**Table C.8-31
XRF POSITIONER MODULE ATTRIBUTES**

Attribute Name	Tag	Type	Attribute Description
Distance Source to Detector	(0018,1110)	3	Distance in mm from source to detector center.
Distance Source to Patient	(0018,1111)	3	Distance in mm from source to isocenter (center of field of view).
Estimated Radiographic Magnification Factor	(0018,1114)	3	Ratio of SID (Source Image Distance) over SOD (Source Object Distance).
Column Angulation	(0018,1450)	3	Angle of the X-Ray beam in degree relative to an orthogonal axis to the detector plane. Positive values indicate that the tilt is towards the head of the table. Note: The detector plane is assumed to be parallel to the table plane.

C.8.7.7 X-Ray Tomography Acquisition Module

This Module describes the attributes of a Tomography acquisition (translation of X-Ray source during the acquisition of a single frame image).

Table C.8-32
X-RAY TOMOGRAPHY ACQUISITION MODULE ATTRIBUTES

Attribute Name	Tag	Type	Attribute Description
Tomo Layer Height	(0018,1460)	1	Distance in mm between the table surface and the sharp image plane.
Tomo Angle	(0018,1470)	3	Angle span in degrees of rotation of X-Ray Source during X-Ray acquisition.
Tomo Time	(0018,1480)	3	Time in seconds the source has taken to rotate the Tomo Angle during X-Ray acquisition.
Tomo Type	(0018,1490)	3	Type of tomography. Defined Terms: LINEAR SPIRAL POLYCYCLOIDAL CIRCULAR
Tomo Class	(0018,1491)	3	Form of tomography: Defined Terms: MOTION TOMOSYNTHESIS
Number of Tomosynthesis Source Images	(0018,1495)	3	The number of source images used to construct this tomosynthetic image. Only meaningful if Tomo Class (0018,1491) is TOMOSYNTHESIS. These may be listed in Source Image Sequence (0008,2112) of the General Image Module.

C.8.7.8 X-Ray Acquisition Dose Module

This Module describes the attributes related to dose delivery from an X-Ray source during the acquisition of an X-Ray image.

Table C.8-33
X-RAY ACQUISITION DOSE MODULE ATTRIBUTES

Attribute Name	Tag	Type	Attribute Description
KVP	(0018,0060)	3	Peak kilo voltage output of the X-Ray generator used.
X-Ray Tube Current	(0018,1151)	3	X-Ray Tube Current in mA.
X-Ray Tube Current in μ A	(0018,8151)	3	X-Ray Tube Current in μ A.
Exposure Time	(0018,1150)	3	Duration of X-Ray exposure in msec.
Exposure Time in μ S	(0018,8150)	3	Duration of X-Ray exposure in μ sec.

Exposure	(0018,1152)	3	The exposure expressed in mAs, for example calculated from Exposure Time and X-ray Tube Current.
Exposure in μ As	(0018,1153)	3	The exposure expressed in μ As, for example calculated from Exposure Time and X-ray Tube Current.
Distance Source to Detector	(0018,1110)	3	Distance in mm from source to detector center. Note: This value is traditionally referred to as Source Image Distance (SID).
Distance Source to Patient	(0018,1111)	3	Distance in mm from source to the table, support or bucky side that is closest to the Imaging Subject, as measured along the central ray of the X-Ray beam. Note: 1. This definition is less useful in terms of estimating geometric magnification than a measurement to a defined point within the Imaging Subject, but accounts for what is realistically measurable in an automated fashion in a clinical setting. 2. This measurement does not take into account any air gap between the Imaging Subject and the "front" of the table or bucky. 3. If the detector is not mounted in a table or bucky, then the actual position relative to the patient is implementation or operator defined. 4. This value is traditionally referred to as Source Object Distance (SOD).
Image Area Dose Product	(0018,115E)	3	X-Ray dose, measured in $\text{dGy}\cdot\text{cm}\cdot\text{cm}$, to which the patient was exposed for the acquisition of this image plus any non-digitally recorded fluoroscopy which may have been performed to prepare for the acquisition of this image. Notes: 1. The sum of the Image Area Dose Product of all images of a Series or a Study may not result in the actual area dose product to which the patient was exposed. 2. This may be an estimated value based on assumptions about the patient's body size and habitus.

Body Part Thickness	(0018,11A0)	3	The average thickness in mm of the body part examined when compressed, if compression has been applied during exposure.
Relative X-Ray Exposure	(0018,1405)	3	Indication of the applied dose, in manufacturer specific units. Notes: 1. This value is intended to provide a single location where manufacturer specific information can be found for annotation on a display or film, that has meaning to a knowledgeable observer. 2. This may be a calculated or measured value. Examples are the detector entrance dose (K_B), the CR sensitivity value (S), or the logarithmic median (lgM).
Entrance Dose	(0040,0302)	3	Average entrance dose value measured in dGy at the surface of the patient during the acquisition of this image. Note: This may be an estimated value based on assumptions about the patient's body size and habitus.
Entrance Dose in mGy	(0040,8302)	3	Average entrance dose value measured in mGy at the surface of the patient during the acquisition of this image. Note: This may be an estimated value based on assumptions about the patient's body size and habitus.
Exposed Area	(0040,0303)	3	Typical dimension of the exposed area at the detector plane. If Rectangular: row dimension followed by column; if Round: diameter. Measured in cm. Notes: 1. The exposed area should be consistent with values specified in the X-Ray Collimator Module, if present. 2. This may be an estimated value based on assumptions about the patient's body size and habitus.
Distance Source to Entrance	(0040,0306)	3	Distance in mm from the source to the surface of the patient closest to the source during the acquisition of this image. Note: This may be an estimated value based on assumptions about the patient's body size and habitus.

Comments on Radiation Dose	(0040,0310)	3	User-defined comments on any special conditions related to radiation dose encountered during the acquisition of this image.
X-Ray Output	(0040,0312)	3	The X-Ray output at the patient entrance surface and kVp used to acquire the image, measured in mGy/mAs. Note: This value may be a calibrated value rather than measured during the exposure.
Half Value Layer	(0040,0314)	3	The thickness of Aluminum in mm required to reduce the X-Ray Output (0040,0312) by a factor of two. Note: This value may be a calibrated value rather than measured during the exposure.
Organ Dose	(0040,0316)	3	Average organ dose value measured in dGy during the acquisition of this image. Note: This may be an estimated value.
Organ Exposed	(0040,0318)	3	Organ to which Organ Dose (0040,0316) applies. Defined Terms: BREAST GONADS BONE MARROW FETUS LENS Note: The anatomic regions described by these terms are those that are particularly radiosensitive and for which it is conventional to obtain organ specific dose parameters.
Anode Target Material	(0018,1191)	3	The primary material in the anode of the X-Ray source. Defined Terms: TUNGSTEN MOLYBDENUM RHODIUM
Filter Material	(0018,7050)	3	The X-Ray absorbing material used in the filter. May be multi-valued. Defined Terms: MOLYBDENUM ALUMINUM COPPER RHODIUM NIOBIUM EUROPIUM LEAD

Filter Thickness Minimum	(0018,7052)	3	The minimum thickness in mm of the X-Ray absorbing material used in the filters. May be multi-valued, with values corresponding to the respective values in Filter Material (0018,7050).
Filter Thickness Maximum	(0018,7054)	3	The maximum thickness in mm of the X-Ray absorbing material used in the filters. May be multi-valued, with values corresponding to the respective values in Filter Material (0018,7050).
Rectification Type	(0018,1156)	3	Type of rectification used in the X-Ray generator. Defined Terms: SINGLE PHASE THREE PHASE CONST POTENTIAL

C.8.7.9 X-Ray Generation Module

This Module describes the attributes related to generation of X-rays during the acquisition of an X-Ray image.

Table C.8-34
X-RAY GENERATION MODULE ATTRIBUTES

Attribute Name	Tag	Type	Attribute Description
KVP	(0018,0060)	3	Peak kilo voltage output of the X-Ray generator used.
X-Ray Tube Current	(0018,1151)	3	X-Ray Tube Current in mA.
X-Ray Tube Current in μ A	(0018,8151)	3	X-Ray Tube Current in μ A.
Exposure Time	(0018,1150)	3	Duration of X-Ray exposure in msec.
Exposure Time in μ S	(0018,8150)	3	Duration of X-Ray exposure in μ sec.
Exposure	(0018,1152)	3	The exposure expressed in mAs, for example calculated from Exposure Time and X-ray Tube Current.
Exposure in μ As	(0018,1153)	3	The exposure expressed in μ As, for example calculated from Exposure Time and X-ray Tube Current.
Exposure Control Mode	(0018,7060)	3	Type of exposure control. Defined Terms: MANUAL AUTOMATIC

Exposure Control Mode Description	(0018,7062)	3	Text description of the mechanism of exposure control. May describe the number and type of exposure sensors or position of the sensitive area of the imaging detector.
Exposure Status	(0018,7064)	3	Whether the exposure was normally completed or not. Defined Terms: NORMAL ABORTED
Phototimer Setting	(0018,7065)	3	Nominal percentage phototimer setting, where a more positive value indicates greater exposure and a more negative value indicates less exposure.
Focal Spot	(0018,1190)	3	Nominal focal spot size in mm used to acquire this image.
Anode Target Material	(0018,1191)	3	The primary material in the anode of the X-Ray source. Defined Terms: TUNGSTEN MOLYBDENUM RHODIUM
Rectification Type	(0018,1156)	3	Type of rectification used in the X-Ray generator. Defined Terms: SINGLE PHASE THREE PHASE CONST POTENTIAL

C.8.7.10 X-Ray Filtration Module

This Module describes the attributes related to the filtration of X-rays during the acquisition of an X-Ray image.

**Table C.8-35
X-RAY FILTRATION MODULE ATTRIBUTES**

Attribute Name	Tag	Type	Attribute Description
Filter Type	(0018,1160)	3	Type of filter(s) inserted into the X-Ray beam (e.g. wedges). Defined Terms: STRIP WEDGE BUTTERFLY MULTIPLE NONE

Filter Material	(0018,7050)	3	The X-Ray absorbing material used in the filter. May be multi-valued. Defined Terms: MOLYBDENUM ALUMINUM COPPER RHODIUM NIOBIUM EUROPIUM LEAD
Filter Thickness Minimum	(0018,7052)	3	The minimum thickness in mm of the X-Ray absorbing material used in the filters. May be multi-valued, with values corresponding to the respective values in Filter Material (0018,7050).
Filter Thickness Maximum	(0018,7054)	3	The maximum thickness in mm of the X-Ray absorbing material used in the filters. May be multi-valued, with values corresponding to the respective values in Filter Material (0018,7050).

C.8.7.11 X-Ray Grid Module

This Module describes the attributes related to the use of a grid to reduce scatter of X-rays during the acquisition of an X-Ray image.

**Table C.8-36
X-RAY GRID MODULE ATTRIBUTES**

Attribute Name	Tag	Type	Attribute Description
Grid	(0018,1166)	3	Identifies the grid. May be multi-valued. Defined Terms are: FIXED FOCUSED RECIPROCATING PARALLEL CROSSED NONE
Grid Absorbing Material	(0018,7040)	3	The X-Ray absorbing material used in the grid.
Grid Spacing Material	(0018,7041)	3	The spacing material used in the grid.
Grid Thickness	(0018,7042)	3	The thickness in mm of the X-Ray absorbing material used in the grid.
Grid Pitch	(0018,7044)	3	The pitch in mm of the X-Ray absorbing material used in the grid.

Grid Aspect Ratio	(0018,7046)	3	Ratio of the vertical spacing and horizontal spacing of the X-Ray absorbing material used in the grid. Specified by a pair of integer values where the first value is the vertical size, and the second value is the horizontal size.
Grid Period	(0018,7048)	3	Period in mSec of reciprocation cycle. Only meaningful if Grid (0018,1166) is RECIPROCATING.
Grid Focal Distance	(0018,704C)	3	Focal distance in mm of a FOCUSED grid.

C.8.8 Radiotherapy Modules

This Section describes Radiotherapy-specific modules.

Modules defined here make reference to "IEC" coordinate systems and standards. These standards are defined in IEC Standard 61217, "Radiotherapy Equipment - Coordinates, Movements and Scales" (Reference CEI/IEC 61217: 1996).

Note: IEC document 62C/269/CDV "Amendment to IEC 61217: Radiotherapy Equipment – Coordinates, movements and scales" also defines a patient-based coordinate system, and specifies the relationship between the DICOM Patient Coordinate System (see Section C.7.6.2.1.1) and the IEC PATIENT Coordinate System. Rotating the IEC PATIENT Coordinate System described in IEC 62C/269/CDV (1999) by 90 degrees counter-clockwise (in the negative direction) about the x-axis yields the DICOM Patient Coordinate System, i.e. $(X_{DICOM}, Y_{DICOM}, Z_{DICOM}) = (X_{IEC}, -Z_{IEC}, Y_{IEC})$. Refer to the latest IEC documentation for the current definition of the IEC PATIENT Coordinate System.

Many of the dosimetry concepts referred to in this document can be found in ICRU Report 50, Prescribing, Recording, and Reporting Photon Beam Therapy, International Commission on Radiation Units and Measurements, 1993.

C.8.8.1 RT Series Module

There exist significant differences in the manner in which RT objects as compared to diagnostic objects. An RT object can be one of several types, and a series of a given object type may be created over a temporal span of several weeks. The RT Series Module has been created to satisfy the requirements of the standard DICOM Query/Retrieve model while including only those attributes relevant to the identification and selection of radiotherapy objects.

Table C.8-33 - RT SERIES MODULE ATTRIBUTES

Attribute Name	Tag	Type	Attribute Description
Modality	(0008,0060)	1	Type of equipment that originally acquired the data. Enumerated Values: RTIMAGE = RT Image RTDOSE = RT Dose RTSTRUCT = RT Structure Set RTPLAN = RT Plan RTRECORD = RT Treatment Record See C.8.8.1.1.
Series Instance UID	(0020,000E)	1	Unique identifier of the series.
Series Number	(0020,0011)	2	A number that identifies this series.
Series Description	(0008,103E)	3	User provided description of the series.
Referenced Study Component Sequence	(0008,1111)	3	Uniquely identifies the Study Component SOP Instances to which the series is related. One or more items may be included in this sequence.
>Referenced SOP Class UID	(0008,1150)	1C	Uniquely identifies the referenced SOP Class. Required if Referenced Study Component (0008,1111) is sent.

>Referenced SOP Instance UID	(0008,1155)	1C	Uniquely identifies the referenced SOP Instance. Required if Referenced Study Component (0008,1111) is sent.
Request Attributes Sequence	(0040,0275)	3	Sequence that contains attributes from the Imaging Service Request. The sequence may have one or more Items.
>Requested Procedure ID	(0040,1001)	1C	Identifier which identifies the Requested Procedure in the Imaging Service Request. Required if Sequence Item is present.
>Scheduled Procedure Step ID	(0040,0009)	1C	Identifier which identifies the Scheduled Procedure Step. Required if Sequence Item is present.
>Scheduled Procedure Step Description	(0040,0007)	3	Institution-generated description or classification of the Scheduled Procedure Step to be performed.
>Scheduled Protocol Code Sequence	(0040,0008)	3	Sequence describing the Scheduled Protocol following a specific coding scheme. This sequence contains one or more Items.
<i>>>Include 'Code Sequence Macro' Table 8.8-1</i>		<i>No Baseline Context ID is defined.</i>	
Performed Procedure Step ID	(0040,0253)	3	Identification of that part of a Procedure that has been carried out within this step.
Performed Procedure Step Start Date	(0040,0244)	3	Date on which the Performed Procedure Step started.
Performed Procedure Step Start Time	(0040,0245)	3	Time on which the Performed Procedure Step started.
Performed Procedure Step Description	(0040,0254)	3	Institution-generated description or classification of the Procedure Step that was performed.
Performed Protocol Sequence	(0040,0260)	3	Sequence describing the Protocol performed for this Procedure Step. One or more Items may be included in this Sequence.
<i>>Include 'Code Sequence Macro' Table 8.8-1</i>		<i>No Baseline Context ID is defined.</i>	

C.8.8.1.1 Modality

The Enumerated Value for Modality (0008,0060) shall determined by the IOD:

RTIMAGE if RT Image IOD,

RTDOSE if RT Dose IOD,

RTSTRUCT if RT Structure Set IOD,

RTPLAN if RT Plan IOD,

RTRECORD if RT Beams Treatment Record IOD, RT Brachy Treatment Record IOD,
or RT Treatment Summary Record IOD.

Note: DICOM specifies that a given series shall contain objects of only one Modality, and shall be created by a single device (described in the General Equipment Module). However, in general there may be many series defined for a given modality/device pair. Note that a radiotherapy series is generally created over an extended time interval (unlike in radiology, where all images in an image series are generally created together).

C.8.8.2 RT Image Module

Table C.8-34 contains attributes that describe RT-specific characteristics of a projection image. The image described by these attributes must be a radiotherapy image acquired or calculated using a conical imaging geometry.

Table C.8-34—RT IMAGE MODULE ATTRIBUTES

Attribute Name	Tag	Type	Attribute Description
Samples per Pixel	(0028,0002)	1	Number of samples (planes) in this image. See C.8.8.2.6.1 for specialization.
Photometric Interpretation	(0028,0004)	1	Specifies the intended interpretation of the pixel data. See C.8.8.2.6.2 for specialization.
Bits Allocated	(0028,0100)	1	Number of bits allocated for each pixel sample. Each sample shall have the same number of bits allocated. See C.8.8.2.6.3 for specialization.
Bits Stored	(0028,0101)	1	Number of bits stored for each pixel sample. Each sample shall have the same number of bits stored. See C.8.8.2.6.4 for specialization.
High Bit	(0028,0102)	1	Most significant bit for each pixel sample. Each sample shall have the same high bit. See C.8.8.2.6.5 for specialization.
Pixel Representation	(0028,0103)	1	Data representation of the pixel samples. Each sample shall have the same pixel representation. See C.8.8.2.6.6 for specialization.
RT Image Label	(3002,0002)	1	User-defined label for RT Image.
RT Image Name	(3002,0003)	3	User-defined name for RT Image.

RT Image Description	(3002,0004)	3	User-defined description of RT Image.
Operators' Name	(0008,1070)	2	Name of operator(s) acquiring or creating RT Image.
Image Type	(0008,0008)	1	Image identification characteristics (see Section C.7.6.1.1.2). RT Images shall use one of the following Defined Terms for Value 3: DRR = digitally reconstructed radiograph PORTAL = digital portal image or portal film image SIMULATOR = conventional simulator image RADIOGRAPH = radiographic image BLANK = image pixels set to background value
Conversion Type	(0008,0064)	2	Describes the kind of image conversion. Defined Terms: DV = Digitized Video DI = Digital Interface DF = Digitized Film WSD = Workstation
Reported Values Origin	(3002,000A)	2C	Describes the origin of the parameter values reported in the image. Required if Value 3 of Image Type (0008,0008) is SIMULATOR or PORTAL. Enumerated Values: OPERATOR = manually entered by operator PLAN = planned parameter values ACTUAL = electronically recorded
RT Image Plane	(3002,000C)	1	Describes whether or not image plane is normal to beam axis. Enumerated Values: NORMAL = image plane normal to beam axis NON_NORMAL = image plane non-normal to beam axis
X-Ray Image Receptor Translation	(3002,000D)	3	Position in (x,y,z) coordinates of origin of IEC X-RAY IMAGE RECEPTOR System in the IEC GANTRY coordinate system (mm). See Note 2.
X-Ray Image Receptor Angle	(3002,000E)	2	X-Ray Image Receptor Angle i.e. orientation of IEC X-RAY IMAGE RECEPTOR coordinate system with respect to IEC GANTRY coordinate system (degrees). See C.8.8.2.2.

RT Image Orientation	(3002,0010)	2C	The direction cosines of the first row and the first column with respect to the IEC X-RAY IMAGE RECEPTOR coordinate system. Required if RT Image Plane (3002,000C) is NON_NORMAL.
Image Plane Pixel Spacing	(3002,0011)	2	Physical distance (in mm) between the center of each image pixel, specified by a numeric pair - adjacent row spacing (delimiter) adjacent column spacing. See C.8.8.2.3.
RT Image Position	(3002,0012)	2	The x and y coordinates (in mm) of the upper left hand corner (first pixel transmitted) of the image, in the IEC X-RAY IMAGE RECEPTOR coordinate system.
Radiation Machine Name	(3002,0020)	2	User-defined name identifying radiation machine used in acquiring or computing image (i.e. name of conventional simulator, electron accelerator, X-ray device, or machine modeled when calculating DRR).
Primary Dosimeter Unit	(300A,00B3)	2	Measurement unit of machine dosimeter. Enumerated Values: MU = Monitor Unit MINUTE = minute
Radiation Machine SAD	(3002,0022)	2	Radiation source to Gantry rotation axis distance of radiation machine used in acquiring or computing image (mm).
Radiation Machine SSD	(3002,0024)	3	Source to patient surface distance (in mm) of radiation machine used in acquiring or computing image.
RT Image SID	(3002,0026)	2	Distance from radiation machine source to image plane (in mm) along radiation beam axis. See C.8.8.2.3.
Source to Reference Object Distance	(3002,0028)	3	Source to reference object distance (in mm), as used for magnification calculation of RADIOGRAPH and SIMULATOR images.
Referenced RT Plan Sequence	(300C,0002)	3	Introduces sequence of one Class/Instance pair describing RT Plan associated with image. Only a single item shall be permitted in this sequence.
>Referenced SOP Class UID	(0008,1150)	1C	Uniquely identifies the referenced SOP Class. Required if Referenced RT Plan Sequence (300C,0002) is sent.
>Referenced SOP Instance UID	(0008,1155)	1C	Uniquely identifies the referenced SOP Instance. Required if Referenced RT Plan Sequence (300C,0002) is sent.

Referenced Beam Number	(300C,0006)	3	Uniquely identifies the corresponding N-segment treatment beam specified by Beam Number (300A,00C0) within Beam Sequence in RT Beams Module within the RT Plan referenced in Referenced RT Plan Sequence (300C,0002).
Referenced Fraction Group Number	(300C,0022)	3	Identifier of Fraction Group within RT Plan referenced in Referenced RT Plan Sequence (300C,0002).
Fraction Number	(3002,0029)	3	Fraction Number of fraction during which image was acquired, within Fraction Group referenced by Referenced Fraction Group Number (300C,0022) within RT Plan referenced in Referenced RT Plan Sequence (300C,0002).
Start Cumulative Meterset Weight	(300C,0008)	3	Cumulative Meterset Weight within Beam referenced by Referenced Beam Number (300C,0006) at which image acquisition starts.
End Cumulative Meterset Weight	(300C,0009)	3	Cumulative Meterset Weight within Beam referenced by Referenced Beam Number (300C,0006) at which image acquisition ends.
Exposure Sequence	(3002,0030)	3	Introduces sequence of Exposure parameter sets, corresponding to exposures used in generating the image. One or more items may be included in this sequence. See C.8.8.2.4.
>Referenced Frame Number	(0008,1160)	1C	Identifies corresponding image frame in multi-frame image. Required if Exposure Sequence (3002,0030) is sent, there is more than one item in Exposure Sequence (3002,0030), and image is a multi-frame image.
>KVP	(0018,0060)	2C	Peak kilo voltage output (kV) of X-ray generator used to acquire image. Required if Value 3 of Image Type (0008,0008) is PORTAL, SIMULATOR or RADIOGRAPH and Exposure Sequence (3002,0030) is sent.
>X-Ray Tube Current	(0018,1151)	2C	Imaging device X-ray Tube Current (mA). Required if Value 3 of Image Type (0008,0008) is SIMULATOR or RADIOGRAPH and Exposure Sequence (3002,0030) is sent.
>Exposure Time	(0018,1150)	2C	Time of X-ray exposure (msec). Required if Value 3 of Image Type (0008,0008) is SIMULATOR or RADIOGRAPH and Exposure Sequence (3002,0030) is sent.

>Meterset Exposure	(3002,0032)	2C	Treatment machine Meterset duration over which image has been acquired, specified in Monitor units (MU) or minutes as defined by Primary Dosimeter Unit (300A,00B3). Required if Value 3 of Image Type (0008,0008) is PORTAL and Exposure Sequence (3002,0030) is sent.
>Diaphragm Position	(3002,0034)	3	Positions of diaphragm jaw pairs (in mm) in IEC BEAM LIMITING DEVICE coordinate axis in the IEC order X1, X2, Y1, Y2.
>Beam Limiting Device Sequence	(300A,00B6)	3	Introduces sequence of beam limiting device (collimator) jaw or leaf (element) positions for given exposure. One or more items may be included in this sequence.
>>RT Beam Limiting Device Type	(300A,00B8)	1C	Type of beam limiting device (collimator). Required if Beam Limiting Device Sequence (300A,00B6) is sent. Enumerated Values: X = symmetric jaw pair in IEC X direction Y = symmetric jaw pair in IEC Y direction ASYMX = asymmetric jaw pair in IEC X direction ASYMY = asymmetric pair in IEC Y direction MLCX = multileaf (multi-element) jaw pair in IEC X direction MLCY = multileaf (multi-element) jaw pair in IEC Y direction
>>Source to Beam Limiting Device Distance	(300A,00BA)	3	Radiation source to beam limiting device (collimator) distance (mm).
>>Number of Leaf/Jaw Pairs	(300A,00BC)	1C	Number of leaf (element) or jaw pairs (equal to 1 for standard beam limiting device jaws). Required if Beam Limiting Device Sequence (300A,00B6) is sent.
>>Leaf Position Boundaries	(300A,00BE)	2C	Boundaries (in mm) of beam limiting device (collimator) leaves (elements) in IEC BEAM LIMITING DEVICE coordinate axis appropriate to RT Beam Limiting Device Type (300A,00B8), i.e. X-axis for MLCY, Y-axis for MLCX. Contains N+1 values, where N is the Number of Leaf/Jaw Pairs (300A,00BC), starting from Leaf (Element) Pair 1. Required if RT Beam Limiting Device Type (300A,00B8) is MLCX or MLCY.

>>Leaf/Jaw Positions	(300A,011C)	1C	Positions of beam limiting device (collimator) leaf or jaw (element) pairs (in mm) in IEC BEAM LIMITING DEVICE coordinate axis appropriate to RT Beam Limiting Device Type (300A,00B8), e.g. X-axis for MLCX, Y-axis for MLCY). Contains 2N values, where N is the Number of Leaf/Jaw Pairs (300A,00BC), in IEC leaf (element) subscript order 101, 102, ... 1N, 201, 202, ... 2N. Required if Beam Limiting Device Sequence (300A,00B6) is sent.
>Applicator Sequence	(300A,0107)	3	Introduces sequence of Applicators associated with Beam. Only a single item shall be permitted in this sequence.
>>Applicator ID	(300A,0108)	1C	User or machine supplied identifier for Applicator. Required if Applicator Sequence (300A,0107) is sent.
>>Applicator Type	(300A,0109)	1C	Type of Applicator. Required if Applicator Sequence (300A,0107) is sent. Defined Terms: ELECTRON_SQUARE = square electron applicator ELECTRON_RECT = rectangular electron applicator ELECTRON_CIRC = circular electron applicator ELECTRON_SHORT = short electron applicator ELECTRON_OPEN = open (dummy) electron applicator INTRAOPERATIVE = intraoperative (custom) applicator STEREOTACTIC = stereotactic applicator
>>Applicator Description	(300A,010A)	3	User-defined description for Applicator.
>Number of Blocks	(300A,00F0)	1C	Number of shielding blocks associated with Beam. Required if Exposure Sequence (3002,0030) is sent.
>Block Sequence	(300A,00F4)	2C	Introduces sequence of blocks associated with Beam. Required if Number of Blocks (300A,00F0) is non-zero. One or more items may be included in this sequence.
>>Block Tray ID	(300A,00F5)	3	User-supplied identifier for block tray.
>>Source to Block Tray Distance	(300A,00F6)	2C	Radiation Source to attachment edge of block tray assembly (mm). Required if Block Sequence (300A,00F4) is sent.

>>Block Type	(300A,00F8)	1C	Type of block. Required if Block Sequence (300A,00F4) is sent. Enumerated Values: SHIELDING = blocking material is inside contour APERTURE = blocking material is outside contour
>>Block Divergence	(300A,00FA)	2C	Indicates presence or otherwise of geometrical divergence. Required if Block Sequence (300A,00F4) is sent. Enumerated Values: PRESENT = block edges are shaped for beam divergence ABSENT = block edges are not shaped for beam divergence
>>Block Number	(300A,00FC)	1C	Identification Number of the Block. The value of Block Number (300A,00FC) shall be unique within the Beam in which it is created. Required if Block Sequence (300A,00F4) is sent.
>>Block Name	(300A,00FE)	3	User-defined name for block.
>>Material ID	(300A,00E1)	2C	User-supplied identifier for material used to manufacture Block. Required if Block Sequence (300A,00F4) is sent.
>>Block Thickness	(300A,0100)	3	Physical thickness of block (in mm) parallel to radiation beam axis.
>>Block Number of Points	(300A,0104)	2C	Number of (x,y) pairs defining the block edge. Required if Block Sequence (300A,00F4) is sent.
>>Block Data	(300A,0106)	2C	A data stream of (x,y) pairs which comprise the block edge. The number of pairs shall be equal to Block Number of Points (300A,0104), and the vertices shall be interpreted as a closed polygon. Coordinates are projected onto the machine isocentric plane in the IEC BEAM LIMITING DEVICE coordinate system (mm). Required if Block Sequence (300A,00F4) is sent.
Gantry Angle	(300A,011E)	3	Treatment machine gantry angle, i.e. orientation of IEC GANTRY coordinate system with respect to IEC FIXED REFERENCE coordinate system (degrees).
Beam Limiting Device Angle	(300A,0120)	3	Treatment machine beam limiting device (collimator) angle, i.e. orientation of IEC BEAM LIMITING DEVICE coordinate system with respect to IEC GANTRY coordinate system (degrees).

Patient Support Angle	(300A,0122)	3	Patient Support angle, i.e. orientation of IEC PATIENT SUPPORT coordinate system with respect to IEC FIXED REFERENCE coordinate system (degrees).
Table Top Eccentric Axis Distance	(300A,0124)	3	Distance (positive) from the IEC PATIENT SUPPORT vertical axis to the IEC TABLE TOP ECCENTRIC vertical axis (mm).
Table Top Eccentric Angle	(300A,0125)	3	Table Top (non-isocentric) angle, i.e. orientation of IEC TABLE TOP ECCENTRIC coordinate system with respect to IEC PATIENT SUPPORT system (degrees).
Table Top Vertical Position	(300A,0128)	3	Table Top Vertical position in IEC TABLE TOP coordinate system (mm).
Table Top Longitudinal Position	(300A,0129)	3	Table Top Longitudinal position in IEC TABLE TOP coordinate system (mm).
Table Top Lateral Position	(300A,012A)	3	Table Top Lateral position in IEC TABLE TOP coordinate system (mm).

- Notes:
1. The numeric beam data parameters recorded with the RT Image correspond to the parameters as they were known at the time the image was created or taken. The parameters may or may not correspond to an actual RT Plan instance that is created for a patient. If the Reported Values Origin (3002,000A) has an enumerated value of OPERATOR or ACTUAL and there is an RT Plan reference present, the numeric beam data parameters may or may not be the same in the two objects.
 2. The Z coordinate of the X-Ray Image Receptor Translation (3002,000D) will be equal to the Radiation Machine SAD (3002,0022) minus the RT Image SID (3002,0026). If the image receptor is further from the beam source than the machine isocenter, the Z coordinate will be negative (see IEC 61217).

C.8.8.2.1 Multi-frame image data

In either multiple exposure multi-frame images or cine images, only the attributes inside of the Exposure Sequence (3002,0030) shall differ between frames. For example, attributes such as beam limiting device (collimator) leaf (element) positions and block information may change, whereas attributes such as gantry and beam limiting device (collimator) angle shall not change.

C.8.8.2.2 X-Ray Image Receptor Angle

The X-Ray Image Receptor Angle (3002,000E) specifies the rotation of the image receptor device in the IEC X-RAY IMAGE RECEPTOR PLANE. A positive angle corresponds to a counter-clockwise rotation of the X-Ray Image Receptor as viewed from the radiation source in the IEC GANTRY coordinate system. The normal (non-rotated) value for this parameter is zero degrees.

C.8.8.2.3 Image Plane Pixel Spacing and RT Image SID

The Image Plane Pixel Spacing (3002,0011) attribute shall always be defined on the image plane, i.e. at the radiation machine source to image plane distance specified by RT Image SID (3002,0026). For images where the source-image distance is undefined or unknown (e.g. DRR images), RT Image SID (3002,0026) shall equal Radiation Machine SAD (3002,0022) and Image Plane Pixel Spacing (3002,0011) shall be defined on this common plane.

C.8.8.2.4 Exposure Sequence

The Exposure Sequence (3002,0030) allows specification of imaging parameters and aperture definitions for single exposure images (single item sequence) or multiple exposures (multiple item sequence). A multiple exposure image can be expressed as a multi-frame image containing either a single frame, or more than one frame. Referenced Frame Number (0008,1160) shall be specified for each Exposure Sequence item for multiple exposure images expressed using more than one frame.

C.8.8.2.5 Single frame and multi-frame images

If the Multi-frame Module is present and the Cine Module is not present then the Frame Increment Pointer (0028,0009) shall have the Enumerated Value of 00200013 (Instance Number). If the Multi-frame Module and Cine Module are both present then the Frame Increment Pointer (0028,0009) shall have an Enumerated Value of either 00181063 (Frame Time) or 00181065 (Frame Time Vector).

C.8.8.2.6 Image Pixel Module Attributes

C.8.8.2.6.1 Samples per Pixel

For RT Images, Samples per Pixel (0028,0002) shall have the Enumerated Value of 0001H.

C.8.8.2.6.2 Photometric Interpretation

For RT Images, Photometric Interpretation (0028,0004) shall have the Enumerated Value of MONOCHROME2.

C.8.8.2.6.3 Bits Allocated

For RT Images, Bits Allocated (0028,0100) shall have an Enumerated Value of 8 or 16.

C.8.8.2.6.4 Bits Stored

For RT Images, Bits Stored (0028,0101) shall have an Enumerated Value of:

8 when Bits Allocated (0028,0100) is 8

12-16 when Bits Allocated (0028,0100) is 16

C.8.8.2.6.5 High Bit

For RT Images, High Bit (0028,0102) shall have the Enumerated Value of one less than the value sent in Bits Stored (0028,0101).

C.8.8.2.6.6 Pixel Representation

For RT Images, Pixel Representation (0028,0103) shall have the Enumerated Value of 0000H (unsigned integer).

C.8.8.3 RT Dose Module

The RT Dose module is used to convey 2D or 3D radiation dose data generated from treatment planning systems or similar devices. The attributes defined within the module support dose for a single radiation beam (potentially comprised of multiple segments, as delivered in a dynamic treatment) or a group of beams comprising either a fraction group (see C.8.8.13) or a complete treatment plan (potentially the sum of multiple fraction groups).

The RT Dose module provides the mechanism to transmit a 3D array of dose data as a set of 2D dose planes which may or may not be related to CT or MR image planes. This mechanism works via the DICOM Multi-Frame module which is required if multi-frame pixel data are sent.

Table C.8-35—RT DOSE MODULE ATTRIBUTES

Attribute Name	Tag	Type	Attribute Description
Samples per Pixel	(0028,0002)	1C	Number of samples (planes) in this image. See C.8.3.4.1 for specialization. Required if Pixel Data (7FE0,0010) is present.
Photometric Interpretation	(0028,0004)	1C	Specifies the intended interpretation of the pixel data. See C.8.3.4.2 for specialization. Required if Pixel Data (7FE0,0010) is present.
Bits Allocated	(0028,0100)	1C	Number of bits allocated for each pixel sample. Each sample shall have the same number of bits allocated. See C.8.3.4.3 for specialization. Required Pixel Data (7FE0,0010) is present.
Bits Stored	(0028,0101)	1C	Number of bits stored for each pixel sample. Each sample shall have the same number of bits stored. See C.8.3.4.4 for specialization. Required if Pixel Data (7FE0,0010) is present.
High Bit	(0028,0102)	1C	Most significant bit for each pixel sample. Each sample shall have the same high bit. See C.8.3.4.5 for specialization. Required if Pixel Data (7FE0,0010) is present.
Pixel Representation	(0028,0103)	1C	Data representation of the pixel samples. Each sample shall have the same pixel representation. See C.8.3.4.6 for specialization. Required Pixel Data (7FE0,0010) is present.
Dose Units	(3004,0002)	1	Units used to describe dose. Enumerated Values: GY = Gray RELATIVE = dose relative to implicit reference value
Dose Type	(3004,0004)	1	Type of dose. Defined Terms: PHYSICAL = physical dose EFFECTIVE = physical dose after correction for biological effect using user-defined modeling technique ERROR = difference between desired and planned dose
Instance Number	(0020,0013)	3	A number that identifies this object instance.
Dose Comment	(3004,0006)	3	User-defined comments for dose data.

Normalization Point	(3004,0008)	3	Coordinates (x, y, z) of normalization point in the patient based coordinate system described in C.7.6.2.1.1 (mm). See C.8.8.3.1.
Dose Summation Type	(3004,000A)	1	Type of dose summation. Defined Terms: PLAN = dose calculated for entire RT Plan FRACTION = dose calculated for a single Fraction Group within RT Plan BEAM = dose calculated for one or more Beams within RT Plan BRACHY = dose calculated for one or more Brachy Application Setups within RT Plan
Referenced RT Plan Sequence	(300C,0002)	1C	Introduces sequence of one Class/Instance pair describing RT Plan associated with dose. Required if Dose Summation Type (3004,000A) is PLAN, FRACTION, BEAM, or BRACHY. Only a single item shall be permitted in this sequence. See Note 1.
>Referenced SOP Class UID	(0008,1150)	1C	Uniquely identifies the referenced SOP Class. Required if Referenced RT Plan Sequence (300C,0002) is sent.
>Referenced SOP Instance UID	(0008,1155)	1C	Uniquely identifies the referenced SOP Instance. Required if Referenced RT Plan Sequence (300C,0002) is sent.
>Referenced Fraction Group Sequence	(300C,0020)	1C	Introduces sequence of one Fraction Group containing beams or brachy application setups contributing to dose. Required if Dose Summation Type (3004,000A) is FRACTION, BEAM, or BRACHY. Only a single item shall be permitted in this sequence. See Note 1.
>>Referenced Fraction Group Number	(300C,0022)	1C	Uniquely identifies Fraction Group specified by Fraction Group Number (300A,0071) in Fraction Group Sequence of RT Fraction Scheme Module within RT Plan referenced in Referenced RT Plan Sequence (300C,0002). Required if Referenced Fraction Group Sequence (300C,0020) is sent.
>>Referenced Beam Sequence	(300C,0004)	1C	Introduces sequence of Beams in current Fraction Group contributing to dose. Required if Dose Summation Type (3004,000A) is BEAM. One or more items may be included in this sequence.

>>>Referenced Beam Number	(300C,0006)	1C	Uniquely identifies Beam specified by Beam Number (300A,00C0) in Beam Sequence of RT Beams Module within RT Plan referenced in Referenced RT Plan Sequence (300C,0002). Required if Referenced Beam Sequence (300A,0004) is sent.
>>Referenced Brachy Application Setup Sequence	(300C,000A)	1C	Introduces sequence of Brachy Application Setups in current Fraction Group contributing to dose. Required if Dose Summation Type (3004,000A) is BRACHY. One or more items may be included in this sequence.
>>>Referenced Brachy Application Setup Number	(300C,000C)	1C	Uniquely identifies Brachy Application Setup specified by Brachy Application Setup Number (300A,0234) in Brachy Application Setup Sequence (300A,0230) of RT Brachy Application Setups Module within RT Plan referenced in Referenced RT Plan Sequence (300C,0002). Required if Referenced Brachy Application Setup Sequence (300C,000A) is sent.
Grid Frame Offset Vector	(3004,000C)	1C	An array which contains the z coordinates (in mm) of the image frames in a multi-frame dose. Required if multi-frame pixel data are present and Frame Increment Pointer (0028,0009) points to Grid Frame Offset Vector (3004,000C). See C.8.8.3.2.
Dose Grid Scaling	(3004,000E)	1	Scaling factor that when multiplied by the dose grid data found in the Pixel Data (7FE0,0010) attribute of the Image Pixel Module, yields grid doses in the dose units as specified by Dose Units (3004,0002).

Note: In order to prevent misrepresentation of dose summation components, if the Dose Summation Type (3004,000A) is PLAN then only a single instance of RT Plan is referenced (i.e. component fraction groups are not referenced). Similarly, if the Dose Summation Type (3004,000A) is FRACTION then only a single instance of RT Plan and a single Fraction Group are referenced (i.e. component beams or brachy application setups are not referenced).

C.8.8.3.1 Normalization Point

The Normalization Point (3004,0008) aids in the interpretation and subsequent use of the transmitted data. If used, it shall be a point receiving dose contributions from all referenced components of the dose summation.

C.8.8.3.2 Grid Frame Offset Vector

Grid Frame Offset Vector (3004,000C) shall be provided if a dose distribution is sent as a multi-frame image. This attribute contains an array of n elements indicating the plane location of the data. This attribute is conditional since the RT Dose module may be included even if pixel doses are not being transmitted, or the image may be a single-frame image. If the Multi-frame Module is present,

Frame Increment Pointer (0028,0009) shall have the Enumerated Value of 3004000C (Grid Frame Offset Vector).

C.8.8.3.3 Dose Units

Dose Units are specified in both the RT Dose and RT Dose ROI modules. The attribute Dose Type present in the RT Dose module shall apply to all doses present in the RT Dose IOD.

C.8.8.3.4 Image Pixel Module Attributes

C.8.8.3.4.1 Samples per Pixel

For RT Doses, Samples per Pixel (0028,0002) shall have the Enumerated Value of 1.

C.8.8.3.4.2 Photometric Interpretation

For RT Doses, Photometric Interpretation (0028,0004) shall have the Enumerated Value of MONOCHROME2.

C.8.8.3.4.3 Bits Allocated

For RT Doses, Bits Allocated (0028,0100) shall have an Enumerated Value of 16 or 32.

C.8.8.3.4.4 Bits Stored

For RT Doses, Bits Stored (0028,0101) shall have an Enumerated Value equal to Bits Allocated (0028,0100).

C.8.8.3.4.5 High Bit

For RT Doses, High Bit (0028,0102) shall have the Enumerated Value of one less than the value sent in Bits Stored (0028,0101).

C.8.8.3.4.6 Pixel Representation

For RT Doses, Pixel Representation (0028,0103) shall have the Enumerated Value of 0000H (unsigned integer).

C.8.8.4 RT DVH Module

The RT DVH module provides for the inclusion of differential or cumulative dose volume histogram data. The data contained within this module may supplement dose data in the RT Dose and/or RT Dose ROI modules, or it may be present in the absence of other dose data.

Table C.8-36—RT DVH MODULE ATTRIBUTES

Attribute Name	Tag	Type	Attribute Description
Referenced Structure Set Sequence	(300C,0060)	1	Introduces sequence of one class/instance pair describing Structure Set containing structures which are used to calculate Dose-Volume Histograms (DVHs). Only a single item shall be permitted in this sequence. See C.8.8.4.1.
>Referenced SOP Class UID	(0008,1150)	1	Uniquely identifies the referenced SOP Class.
>Referenced SOP Instance UID	(0008,1155)	1	Uniquely identifies the referenced SOP Instance.

DVH Normalization Point	(3004,0040)	3	Coordinates (x, y, z) of common DVH normalization point in the patient based coordinate system described in C.7.6.2.1.1 (mm).
DVH Normalization Dose Value	(3004,0042)	3	Dose Value at DVH Normalization Point (3004,0040) used as reference for individual DVHs when Dose Units (3004,0002) is RELATIVE.
DVH Sequence	(3004,0050)	1	Introduces sequence of DVHs. One or more items may be included in this sequence.
>DVH Referenced ROI Sequence	(3004,0060)	1	Introduces sequence of referenced ROIs used to calculate DVH.
>>Referenced ROI Number	(3006,0084)	1	Uniquely identifies ROI used to calculate DVH specified by ROI Number (3006,0022) in Structure Set ROI Sequence (3006,0020) in Structure Set Module within RT Structure Set referenced by referenced RT Plan in Referenced RT Plan Sequence (300C,0002) in RT Dose Module.
>>DVH ROI Contribution Type	(3004,0062)	1	Specifies whether volume within ROI is included or excluded in DVH. See C.8.8.4.2. Enumerated Values: INCLUDED, EXCLUDED.
>DVH Type	(3004,0001)	1	Type of DVH. Enumerated Values: DIFFERENTIAL = differential dose-volume histogram CUMULATIVE = cumulative dose-volume histogram
>Dose Units	(3004,0002)	1	Dose axis units. Enumerated Values: GY = Gray RELATIVE = dose relative to reference value specified in DVH Normalization Dose Value (3004,0042)
>Dose Type	(3004,0004)	1	Type of dose. Defined Terms: PHYSICAL = physical dose EFFECTIVE = physical dose after correction for biological effect using user-defined modeling technique ERROR = difference between desired and planned dose

>DVH Dose Scaling	(3004,0052)	1	Scaling factor that when multiplied by the dose bin widths found in DVH Data (3004,0058), yields dose bin widths in the dose units as specified by Dose Units (3004,0002).
>DVH Volume Units	(3004,0054)	1	Volume axis units. Defined Terms: CM3 = cubic centimeters PERCENT = percent
>DVH Number of Bins	(3004,0056)	1	Number of bins n used to store DVH Data (3004,0058).
>DVH Data	(3004,0058)	1	A data stream describing the dose bin widths D_n and associated volumes V_n in the order $D_1V_1, D_2V_2, \dots, D_nV_n$.
>DVH Minimum Dose	(3004,0070)	3	Minimum calculated dose to ROI(s) described by DVH Referenced ROI Sequence (3004,0060).
>DVH Maximum Dose	(3004,0072)	3	Maximum calculated dose to ROI(s) described by DVH Referenced ROI Sequence (3004,0060).
>DVH Mean Dose	(3004,0074)	3	Mean calculated dose to ROI(s) described by DVH Referenced ROI Sequence (3004,0060).

C.8.8.4.1 Referenced Structure Set Sequence

The Referenced Structure Set Sequence (300C,0060) is required for direct cross-reference of the dose bin data with the corresponding ROI(s) from which they were derived. ROIs referenced by the DVH Referenced ROI Sequence (3004,0050) shall only contain contours with a Contour Geometric Type (3006,0042) of POINT or CLOSED_PLANAR.

C.8.8.4.2 DVH ROI Contribution Type

The volume used to calculate the DVH shall be the geometric union of ROIs where DVH ROI Contribution Type (3004,0062) is INCLUDED, minus the geometric union of ROIs where DVH ROI Contribution Type (3004,0062) is EXCLUDED.

C.8.8.5 Structure Set Module

A structure set defines a set of areas of significance. Each area can be associated with a Frame of Reference and zero or more images. Information which can be transferred with each region of interest (ROI) includes geometrical and display parameters, and generation technique.

Table C.8-37—STRUCTURE SET MODULE ATTRIBUTES

Attribute Name	Tag	Type	Attribute Description
Structure Set Label	(3006,0002)	1	User-defined label for Structure Set.
Structure Set Name	(3006,0004)	3	User-defined name for Structure Set.
Structure Set Description	(3006,0006)	3	User-defined description for Structure Set.

Instance Number	(0020,0013)	3	A number that identifies this object instance.
Structure Set Date	(3006,0008)	2	Date at which Structure Set was last modified.
Structure Set Time	(3006,0009)	2	Time at which Structure Set was last modified.
Referenced Frame of Reference Sequence	(3006,0010)	3	Introduces sequence of items describing Frames of Reference in which the ROIs are defined. One or more items may be included in this sequence. See C.8.8.5.1.
>Frame of Reference UID	(0020,0052)	1C	Uniquely identifies Frame of Reference within Structure Set. Required if Referenced Frame of Reference Sequence (3006,0010) is sent.
>Frame of Reference Relationship Sequence	(3006,00C0)	3	Introduces sequence of transforms that relate other Frames of Reference to this Frame of Reference.
>>Related Frame of Reference UID	(3006,00C2)	1C	Frame of Reference Coordinate System to be transformed to the current Frame of Reference. Required if Frame of Reference Relationship Sequence (3006,00C0) is sent.
>>Frame of Reference Transformation Type	(3006,00C4)	1C	Type of Transformation. Required if Frame of Reference Relationship Sequence (3006,00C0) is sent. Defined Terms: HOMOGENEOUS
>>Frame of Reference Transformation Matrix	(3006,00C6)	1C	Four-by-four transformation Matrix from Related Frame of Reference to current Frame of Reference. Matrix elements shall be listed in row-major order. Required if Frame of Reference Relationship Sequence (3006,00C0) is sent. See C.8.8.5.2.
>>Frame of Reference Transformation Comment	(3006,00C8)	3	Comment regarding the transformation between the related and current Frames of Reference.
>RT Referenced Study Sequence	(3006,0012)	3	Introduces sequence of Studies containing series to be referenced. One or more items may be included in this sequence.
>>Referenced SOP Class UID	(0008,1150)	1C	Uniquely identifies the referenced SOP Class. Required if RT Referenced Study Sequence (3006,0012) is sent.
>>Referenced SOP Instance UID	(0008,1155)	1C	Uniquely identifies the referenced SOP Instance. Required if RT Referenced Study Sequence (3006,0012) is sent.

>>RT Referenced Series Sequence	(3006,0014)	1C	Introduces sequence of items describing series of images within the referenced study which are used in defining the Structure Set. Required if RT Referenced Study Sequence (3006,0012) is sent. One or more items may be included in this sequence.
>>>Series Instance UID	(0020,000E)	1C	Unique identifier for the series containing the images. Required if RT Referenced Series Sequence (3006,0014) is sent.
>>>Contour Image Sequence	(3006,0016)	1C	Introduces sequence of items describing images in a given series used in defining the Structure Set (typically CT or MR images). Required if RT Referenced Series Sequence (3006,0014) is sent. One or more items may be included in this sequence.
>>>>Referenced SOP Class UID	(0008,1150)	1C	Uniquely identifies the referenced image SOP Class. Required if Contour Image Sequence (3006,0016) is sent.
>>>>Referenced SOP Instance UID	(0008,1155)	1C	Uniquely identifies the referenced image SOP Instance. Required if Contour Image Sequence (3006,0016) is sent.
>>>>Referenced Frame Number	(0008,1160)	3	Identifies image frame if a multi-frame image is referenced.
Structure Set ROI Sequence	(3006,0020)	3	Introduces sequence of ROIs for current Structure Set. One or more items may be included in this sequence.
>ROI Number	(3006,0022)	1C	Identification number of the ROI. The value of ROI Number (3006,0022) shall be unique within the Structure Set in which it is created. Required if Structure Set ROI Sequence (3006,0020) is sent.
>Referenced Frame of Reference UID	(3006,0024)	1C	Uniquely identifies Frame of Reference in which ROI is defined, specified by Frame of Reference UID (0020,0052) in Referenced Frame of Reference Sequence (3006,0010). Required if Structure Set ROI Sequence (3006,0020) is sent.
>ROI Name	(3006,0026)	2C	User-defined name for ROI. Required if Structure Set ROI Sequence (3006,0020) is sent.
>ROI Description	(3006,0028)	3	User-defined description for ROI.
>ROI Volume	(3006,002C)	3	Volume of ROI (cubic centimeters).

>ROI Generation Algorithm	(3006,0036)	2C	Type of algorithm used to generate ROI. Required if Structure Set ROI Sequence (3006,0020) is sent. Defined Terms: AUTOMATIC = calculated ROI SEMIAUTOMATIC = ROI calculated with user assistance MANUAL = user-entered ROI
>ROI Generation Description	(3006,0038)	3	User-defined description of technique used to generate ROI.

C.8.8.5.1 Frames of Reference

The Referenced Frame of Reference Sequence (3006,0010) describes a set of frames of reference in which some or all of the ROIs are expressed. Since the Referenced Frame of Reference UID (3006,0024) is required for each ROI, each frame of reference used to express the coordinates of an ROI shall be listed in the Referenced Frame of Reference Sequence (3006,0010) once and only once.

- Notes:
1. As an example, a set of ROIs defined using a single image series would list the image series in a single Referenced Frame of Reference Sequence (3006,0010) item, providing the UID for this referenced frame of reference (obtained from the source images), and listing all pertinent images in the Contour Image Sequence (3006,0016).
 2. As an example, a set of ROIs containing ROIs referencing more than one frame of reference would list the referenced images in two or more different Referenced Frame of Reference Sequence (3006,0010) items, providing in each case the UID for this referenced frame of reference (obtained from the source images), and listing all pertinent images in the Contour Image Sequence (3006,0016). Each ROI would then reference the appropriate Frame of Reference UID (0020,0052).

C.8.8.5.2 Frame of Reference Transformation Matrix

In a rigid body system, two coordinate systems can be related using a single 4 x 4 transformation matrix to describe any rotations and/or translations necessary to transform coordinates from the related coordinate system (frame of reference) to the primary system. The equation performing the transform from a point (X',Y',Z') in the related coordinate system to a point (X,Y,Z) in the current coordinate system can be shown as follows, where for homogeneous transforms $M_{41} = M_{42} = M_{43} = 0$ and $M_{44} = 1$:

$$\begin{array}{rcl}
 X & M_{11} & M_{12} & M_{13} & M_{14} & X \\
 Y & = & M_{21} & M_{22} & M_{23} & M_{24} & x & Y' \\
 Z & & M_{31} & M_{32} & M_{33} & M_{34} & Z' \\
 1 & & M_{41} & M_{42} & M_{43} & M_{44} & 1
 \end{array}$$

C.8.8.6 ROI Contour Module

In general, a ROI can be defined by either a sequence of overlays or a sequence of contours. This module, if present, is used to define the ROI as a set of contours. Each ROI contains a sequence of one or more contours, where a contour is either a single point (for a point ROI) or more than one point (representing an open or closed polygon).

Table C.8-38—ROI CONTOUR MODULE ATTRIBUTES

Attribute Name	Tag	Type	Attribute Description
ROI Contour Sequence	(3006,0039)	1	Introduces sequence of Contour Sequences defining ROIs. One or more items may be included in this sequence.
>Referenced ROI Number	(3006,0084)	1	Uniquely identifies the referenced ROI described in the Structure Set ROI Sequence (3006,0020).
>ROI Display Color	(3006,002A)	3	RGB triplet color representation for ROI, specified using the range 0-255.
>Contour Sequence	(3006,0040)	3	Introduces sequence of Contours defining ROI. One or more items may be included in this sequence.
>>Contour Number	(3006,0048)	3	Identification number of the contour. The value of Contour Number (3006,0048) shall be unique within the Contour Sequence (3006,0040) in which it is defined. No semantics or ordering shall be inferred from this attribute.
>>Attached Contours	(3006,0049)	3	List of Contour Number (3006,0048) defining lower-numbered contour(s) to which the current contour is connected.
>>Contour Image Sequence	(3006,0016)	3	Introduces sequence of images containing the contour. One or more items may be included in this sequence.
>>>Referenced SOP Class UID	(0008,1150)	1C	Uniquely identifies the referenced image SOP Class of the image containing the Contour, if it exists. Required if Contour Image Sequence (3006,0016) is sent.
>>>Referenced SOP Instance UID	(0008,1155)	1C	Uniquely identifies the referenced image SOP Instance of the image containing the Contour, if it exists. Required if Contour Image Sequence (3006,0016) is sent.
>>>Referenced Frame Number	(0008,1160)	1C	Identifies image frame if a multi-frame image is referenced. Required if referenced image is a multi-frame image.

>>Contour Geometric Type	(3006,0042)	1C	Geometric type of contour. Required if Contour Sequence (3006,0040) is sent. See C.8.8.6.1. Enumerated Values: POINT = single point OPEN_PLANAR = open contour containing coplanar points OPEN_NONPLANAR = open contour containing non-coplanar points CLOSED_PLANAR = closed contour (polygon) containing coplanar points
>>Contour Slab Thickness	(3006,0044)	3	Thickness of slab (in mm) represented by contour, where the Contour Data (3006,0050) defines a plane in the center of the slab, offset by the Contour Offset Vector (3006,0045) if it is present. See C.8.8.6.2.
>>Contour Offset Vector	(3006,0045)	3	Vector (x,y,z) in the the patient based coordinate system described in C.7.6.2.1.1 which is normal to plane of Contour Data (3006,0050), describing direction and magnitude of the offset (in mm) of each point of the central plane of a contour slab from the corresponding original point of Contour Data (3006,0050). See C.8.8.6.2.
>>Number of Contour Points	(3006,0046)	1C	Number of points (triplets) in Contour Data (3006,0050). Required if Contour Sequence (3006,0040) is sent.
>>Contour Data	(3006,0050)	1C	Sequence of (x,y,z) triplets defining a contour in the patient based coordinate system described in C.7.6.2.1.1 (mm). Required if Contour Sequence (3006,0040) is sent. See C.8.8.6.1.

C.8.8.6.1 Contour Geometric Type

A contour can be one of the following geometric types:

- A Contour Geometric Type (3006,0042) of POINT indicates that the contour is a single point, defining a specific location of significance.
- A Contour Geometric Type (3006,0042) of OPEN_PLANAR indicates that the last vertex shall *not* be connected to the first point, and that all points in Contour Data (3006,0050) shall be coplanar.
- A Contour Geometric Type (3006,0042) of OPEN_NONPLANAR indicates that the last vertex shall *not* be connected to the first point, and that the points in Contour Data (3006,0050) may be non-coplanar. Contours having a Geometric Type (3006,0042) of OPEN_NONPLANAR can

be used to represent objects best described by a single, possibly non-coplanar curve, such as a brachytherapy applicator.

- A Contour Geometric Type (3006,0042) of CLOSED_PLANAR indicates that the last point shall be connected to the first point, where the first point is not repeated in the Contour Data (3006,0050). All points in Contour Data (3006,0050) shall be coplanar.

C.8.8.6.2 Contour Slab Thickness

A set of Contour slabs may define a multi-slab Volume of Interest. Contour Slab Thickness (3006,0044) shall specify the thickness of a slab, the central plane of which shall be defined by the set of points offset from Contour Data (3006,0050) by the value of Contour Offset Vector (3006,0045). One contour slab may contain one to many sets of Contour Data (3006,0050) that may define regions of one complex Volume of Interest. If no valid value of Contour Slab Thickness (3006,0044) is sent, then the offset value shall be (0,0,0) and the original Contour Data (3006,0050) shall define the central plane of the Contour slab.

C.8.8.7 RT Dose ROI Module

RT Dose ROI provides ancillary dose-related information to the ROI data defined within the Structure Set and ROI Contour modules, which may be included in the RT Dose IOD composite object. These modules in combination provide for the definition of dose data in the form of *isodose curves* or named or unnamed dose points. Isodose curves in radiation oncology are simply contours identifying a set of points with the same dose value.

Table C.8-39—RT DOSE ROI MODULE ATTRIBUTES

Attribute Name	Tag	Type	Attribute Description
RT Dose ROI Sequence	(3004,0010)	1	Introduces sequence of items specifying dose levels for isodose curves or dose points described in the ROI module. One or more items may be included in this sequence. See C.8.8.7.1.
>Referenced ROI Number	(3006,0084)	1	Uniquely identifies the referenced ROI within the current RT Dose. See Note 1 and C.8.8.7.2.
>Dose Units	(3004,0002)	1	Units used for ROI Dose. Enumerated Values: GY = Gray RELATIVE = dose relative to implicit reference value
>Dose Value	(3004,0012)	1	Dose value for ROI, in units defined by Dose Units (3004,0002). See C.8.8.7.3.

- Notes:
1. The Structure Set ROI Sequence (3006,0020) defining the dose point and surfaces is defined in the Structure Set module. The ROI Number (3006,0022) attribute is unique within the Structure Set ROI Sequence, and is referenced from the RT Dose ROI module using Referenced ROI Number (3006,0084).
 2. The RT Dose ROI module defines the attributes that describe references to ROIs contained within the associated Structure Set and RT ROI Contour modules. Note that the RT Dose module table specifies that either all or none of the modules Structures Set, ROI Contour, and RT Dose ROI must be present in the RT Dose IOD.

C.8.8.7.1 Contour Geometric Type of Referenced ROI

ROIs referenced in the RT Dose ROI Module shall have a Contour Geometric Type (3006,0042) of POINT, OPEN_PLANAR or CLOSED_PLANAR.

C.8.8.7.2 Referenced ROI Number

There shall be a one-to-one correspondence between Referenced ROI Number (3006,0084) and the sequence of ROIs defined in the Structure Set and ROI Contour modules. The RT Dose ROI module shall only contain references to structures which are dose-related (i.e. dose points and isodose curves).

C.8.8.7.3 Dose Value

Dose Value (3004,0012) shall be the dose value corresponding to the referenced isodose curve, named dose point, or unnamed dose point.

C.8.8.8 RT ROI Observations Module

The RT ROI Observations module specifies the identification and interpretation of an ROI specified in the Structure Set and ROI Contour modules.

Table C.8-40—RT ROI OBSERVATIONS MODULE ATTRIBUTES

Attribute Name	Tag	Type	Attribute Description
RT ROI Observations Sequence	(3006,0080)	1	Introduces sequence of observations related to ROIs defined in the ROI Module. One or more items may be included in this sequence.
>Observation Number	(3006,0082)	1	Identification number of the Observation. The value of Observation Number (3006,0082) shall be unique within the RT ROI Observations Sequence (3006,0080).
>Referenced ROI Number	(3006,0084)	1	Uniquely identifies the referenced ROI described in the Structure Set ROI Sequence (3006,0020).
>ROI Observation Label	(3006,0085)	3	User-defined label for ROI Observation.
>ROI Observation Description	(3006,0088)	3	User-defined description for ROI Observation.
>RT Related ROI Sequence	(3006,0030)	3	Introduces sequence of significantly related ROIs, e.g. CTVs contained within a PTV. One or more items may be included in this sequence.
>>Referenced ROI Number	(3006,0084)	1C	Uniquely identifies the related ROI described in the Structure Set ROI Sequence (3006,0020). Required if RT Related ROI Sequence (3006,0030) is sent.

>>RT ROI Relationship	(3006,0033)	3	<p>Relationship of referenced ROI with respect to referencing ROI.</p> <p>Defined Terms:</p> <p>SAME = ROIs represent the same entity</p> <p>ENCLOSED = referenced ROI completely encloses referencing ROI</p> <p>ENCLOSING = referencing ROI completely encloses referenced ROI</p>
>RT ROI Identification Code Sequence	(3006,0086)	3	<p>Introduces sequence containing Code used to identify ROI. If this sequence is included, only one item shall be present. Baseline Context ID Number = 96. See Section 5.3 for further explanation.</p>
>>Include 'Code Sequence Macro' Table 8.8-1		<i>Baseline Context ID is 96 .</i>	
>Related RT ROI Observations Sequence	(3006,00A0)	3	<p>Introduces sequence of related ROI Observations. One or more items may be included in this sequence.</p>
>>Observation Number	(3006,0082)	1C	<p>Uniquely identifies a related ROI Observation. Required if Related RT ROI Observations Sequence (3006,00A0) is sent.</p>

>RT ROI Interpreted Type	(3006,00A4)	2	<p>Type of ROI. See C.8.8.8.1.</p> <p>Defined Terms:</p> <p>EXTERNAL = external patient contour</p> <p>PTV = Planning Target Volume (as defined in ICRU50)</p> <p>CTV = Clinical Target Volume (as defined in ICRU50)</p> <p>GTV = Gross Tumor Volume (as defined in ICRU50)</p> <p>TREATED_VOLUME = Treated Volume (as defined in ICRU50)</p> <p>IRRAD_VOLUME = Irradiated Volume (as defined in ICRU50)</p> <p>BOLUS = patient bolus to be used for external beam therapy</p> <p>AVOIDANCE = region in which dose is to be minimized</p> <p>ORGAN = patient organ</p> <p>MARKER = patient marker</p> <p>REGISTRATION = registration ROI</p> <p>ISOCENTER = treatment isocenter to be used for external beam therapy</p> <p>CONTRAST_AGENT = volume into which a contrast agent has been injected</p> <p>CAVITY = patient anatomical cavity</p> <p>BRACHY_CHANNEL = brachytherapy channel</p> <p>BRACHY_ACCESSORY = brachytherapy accessory device</p> <p>BRACHY_SRC_APP = brachytherapy source applicator</p> <p>BRACHY_CHNL_SHLD = brachytherapy channel shield</p>
>ROI Interpreter	(3006,00A6)	2	Name of person performing the interpretation.
>Material ID	(300A,00E1)	3	User-supplied identifier for ROI material.
>ROI Physical Properties Sequence	(3006,00B0)	3	Introduces sequence describing physical properties associated with current ROI interpretation. One or more items may be included in this sequence.

>>ROI Physical Property	(3006,00B2)	1C	Physical property specified by ROI Physical Property Value (3006,00B4). Required if ROI Physical Properties Sequence (3006,00B0) is sent. Defined Terms: REL_MASS_DENSITY = mass density relative to water REL_ELEC_DENSITY = electron density relative to water EFFECTIVE_Z = effective atomic number EFF_Z_PER_A = effective ratio of atomic number to mass (AMU ⁻¹)
>>ROI Physical Property Value	(3006,00B4)	1C	User-assigned value for physical property. Required if ROI Physical Properties Sequence (3006,00B0) is sent.

C.8.8.8.1 RT ROI Interpreted Type

RT ROI Interpreted Type (3006,00A4) shall describe the class of ROI (e.g. CTV, PTV). Individual instances of each class of structure (e.g. CTV1, CTV2) can be distinguished using ROI Observation Label (3006,0085).

C.8.8.9 RT General Plan Module

Table C.8-41—RT GENERAL PLAN MODULE ATTRIBUTES

Attribute Name	Tag	Type	Attribute Description
RT Plan Label	(300A,0002)	1	User-defined label for treatment plan.
RT Plan Name	(300A,0003)	3	User-defined name for treatment plan.
RT Plan Description	(300A,0004)	3	User-defined description of treatment plan.
Instance Number	(0020,0013)	3	A number that identifies this object instance.
Operators' Name	(0008,1070)	2	Name of operator(s) creating treatment plan.
RT Plan Date	(300A,0006)	2	Date treatment plan was last modified.
RT Plan Time	(300A,0007)	2	Time treatment plan was last modified.
Treatment Protocols	(300A,0009)	3	Planned treatment protocols.
Treatment Intent	(300A,000A)	3	Intent of this course of treatment. Defined Terms: CURATIVE PALLIATIVE PROPHYLACTIC
Treatment Sites	(300A,000B)	3	Planned treatment sites.

RT Plan Geometry	(300A,000C)	1	Describes whether RT Plan is based on patient or treatment device geometry. See C.8.8.9.1. Defined Terms: PATIENT = RT Structure Set exists TREATMENT_DEVICE = RT Structure Set does not exist
Referenced Structure Set Sequence	(300C,0060)	1C	Introduces sequence of one Class/Instance pair describing instance of RT Structure Set on which the RT Plan is based. Only a single item shall be permitted in this sequence. Required if RT Plan Geometry (300A,000C) is PATIENT.
>Referenced SOP Class UID	(0008,1150)	1C	Uniquely identifies the referenced SOP Class. Required if Referenced Structure Set Sequence (300C,0060) is sent.
>Referenced SOP Instance UID	(0008,1155)	1C	Uniquely identifies the referenced SOP Instance. Required if Referenced Structure Set Sequence (300C,0060) is sent.
Referenced Dose Sequence	(300C,0080)	3	Introduces sequence of related SOP Class/Instance pairs describing related instances of RT Dose (for grids and named/unnamed point doses). One or more items may be included in this sequence. See Note 1.
>Referenced SOP Class UID	(0008,1150)	1C	Uniquely identifies the referenced SOP Class. Required if Referenced RT Dose Sequence (300C,0080) is sent.
>Referenced SOP Instance UID	(0008,1155)	1C	Uniquely identifies the referenced SOP Instance. Required if Referenced RT Dose Sequence (300C,0080) is sent.
Referenced RT Plan Sequence	(300C,0002)	3	Introduces sequence of related SOP Class/Instance pairs describing related instances of RT Plan. One or more items may be included in this sequence.
>Referenced SOP Class UID	(0008,1150)	1C	Uniquely identifies the referenced SOP Class. Required if Referenced RT Plan Sequence (300C,0002) is sent.
>Referenced SOP Instance UID	(0008,1155)	1C	Uniquely identifies the referenced SOP Instance. Required if Referenced RT Plan Sequence (300C,0002) is sent.

>RT Plan Relationship	(300A,0055)	1C	<p>Relationship of referenced plan with respect to current plan. Required if Referenced RT Plan Sequence (300C,0002) is sent.</p> <p>Defined Terms:</p> <p>PRIOR = plan delivered prior to current treatment</p> <p>ALTERNATIVE = alternative plan prepared for current treatment</p> <p>PREDECESSOR = plan used in derivation of current plan</p>
-----------------------	-------------	----	--

Note: An RT Dose IOD referenced within the Referenced Dose Sequence (300C,0080) can be used for storing grid-based (pixel) data, individual dose points (with optional dose point names), isodose curves, and DVH's.

C.8.8.9.1 Referenced Structure Set Sequence

An RT Plan Geometry (300A,000C) of PATIENT shall signify that an RT Structure Set has been defined upon which the plan geometry is based, and this RT Structure Set shall be specified in the Referenced Structure Set Sequence (300C,0060). An RT Plan Geometry (300A,000C) of TREATMENT_DEVICE shall indicate that no patient geometry is available, and that the RT Plan is being defined with respect to the IEC FIXED Coordinate System.

C.8.8.10 RT Prescription Module

Table C.8-42—RT PRESCRIPTION MODULE ATTRIBUTES

Attribute Name	Tag	Type	Attribute Description
Prescription Description	(300A,000E)	3	User-defined description of treatment prescription.
Dose Reference Sequence	(300A,0010)	3	Introduces sequence of Dose References. One or more items may be included in this sequence.
>Dose Reference Number	(300A,0012)	1C	Identification number of the Dose Reference. The value of Dose Reference Number (300A,0012) shall be unique within the RT Plan in which it is created. Required if Dose Reference Sequence (300A,0012) is sent.

>Dose Reference Structure Type	(300A,0014)	1C	Structure type of Dose Reference. Required if Dose Reference Sequence (300A,0010) is sent. Defined Terms: POINT = dose reference point specified as ROI VOLUME = dose reference volume specified as ROI COORDINATES = point specified by Dose Reference Point Coordinates (300A,0018) SITE = dose reference clinical site
>Dose Reference Description	(300A,0016)	3	User-defined description of Dose Reference.
>Referenced ROI Number	(3006,0084)	1C	Uniquely identifies ROI representing the dose reference specified by ROI Number (3006,0022) in Structure Set ROI Sequence (3006,0020) in Structure Set Module within RT Structure Set in Referenced Structure Set Sequence (300C,0060) in RT General Plan Module. Required if Dose Reference Structure Type (300A,0014) is POINT or VOLUME and Dose Reference Sequence (300A,0010) is sent.
>Dose Reference Point Coordinates	(300A,0018)	1C	Coordinates (x,y,z) of Reference Point in the patient based coordinate system described in C.7.6.2.1.1 (mm). Required if Dose Reference Structure Type (300A,0014) is COORDINATES and Dose Reference Sequence (300A,0010) is sent.
>Nominal Prior Dose	(300A,001A)	3	Dose (in Gy) from prior treatment to this Dose Reference (e.g. from a previous course of treatment).
>Dose Reference Type	(300A,0020)	1C	Type of Dose Reference. Required if Dose Reference Sequence (300A,0010) is sent. Defined Terms: TARGET = treatment target (corresponding to GTV, PTV, or CTV in ICRU50) ORGAN_AT_RISK = Organ at Risk (as defined in ICRU50)
>Constraint Weight	(300A,0021)	3	Relative importance of satisfying constraint, where high values represent more important constraints.
>Delivery Warning Dose	(300A,0022)	3	The dose (in Gy) which when reached or exceeded should cause some action to be taken.
>Delivery Maximum Dose	(300A,0023)	3	The maximum dose (in Gy) which can be delivered to the dose reference.

>Target Minimum Dose	(300A,0025)	3	Minimum permitted dose (in Gy) to Dose Reference if Dose Reference Type (300A,0020) is TARGET.
>Target Prescription Dose	(300A,0026)	3	Prescribed dose (in Gy) to Dose Reference if Dose Reference Type (300A,0020) is TARGET.
>Target Maximum Dose	(300A,0027)	3	Maximum permitted dose (in Gy) to Dose Reference if Dose Reference Type (300A,0020) is TARGET.
>Target Underdose Volume Fraction	(300A,0028)	3	Maximum permitted fraction (in percent) of Target to receive less than the Target Prescription Dose if Dose Reference Type (300A,0020) is TARGET and Dose Reference Structure Type (300A,0014) is VOLUME. See C.8.8.10.1.
>Organ at Risk Full-volume Dose	(300A,002A)	3	Maximum dose (in Gy) to entire Dose Reference if Dose Reference Type (300A,0020) is ORGAN_AT_RISK and Dose Reference Structure Type (300A,0014) is VOLUME.
>Organ at Risk Limit Dose	(300A,002B)	3	Maximum permitted dose (in Gy) to any part of Dose Reference if Dose Reference Type (300A,0020) is ORGAN_AT_RISK and Dose Reference Structure Type (300A,0014) is VOLUME.
>Organ at Risk Maximum Dose	(300A,002C)	3	Maximum dose (in Gy) to non-overdosed part of Dose Reference if Dose Reference Type (300A,0020) is ORGAN_AT_RISK and Dose Reference Structure Type (300A,0014) is VOLUME.
>Organ at Risk Overdose Volume Fraction	(300A,002D)	3	Maximum permitted fraction (in percent) of the Organ at Risk to receive more than the Organ at Risk Maximum Dose if Dose Reference Type (300A,0020) is ORGAN_AT_RISK and Dose Reference Structure Type (300A,0014) is VOLUME.

C.8.8.10.1 Target Underdose Volume Fraction

If the Target Underdose Volume Fraction (300A,0028) is not present, it shall be interpreted as zero.

C.8.8.11 RT Tolerance Tables Module

Table C.8-43—RT TOLERANCE TABLES MODULE ATTRIBUTES

Attribute Name	Tag	Type	Attribute Description
Tolerance Table Sequence	(300A,0040)	3	Introduces sequence of tolerance tables to be used for delivery of treatment plan. One or more items may be included in this sequence. See Note 1.
>Tolerance Table Number	(300A,0042)	1C	Identification number of the Tolerance Table. The value of Tolerance Table Number (300A,0042) shall be unique within the RT Plan in which it is created. Required if Tolerance Table Sequence (300A,0040) is sent.
>Tolerance Table Label	(300A,0043)	3	User-defined label for Tolerance Table.
>Gantry Angle Tolerance	(300A,0044)	3	Maximum permitted difference (in degrees) between planned and delivered Gantry Angle.
>Beam Limiting Device Angle Tolerance	(300A,0046)	3	Maximum permitted difference (in degrees) between planned and delivered Beam Limiting Device Angle.
>Beam Limiting Device Tolerance Sequence	(300A,0048)	3	Introduces sequence of beam limiting device (collimator) tolerances. One or more items may be included in this sequence.
>>RT Beam Limiting Device Type	(300A,00B8)	1C	Type of beam limiting device (collimator). Required if Beam Limiting Device Tolerance Sequence (300A,0040) is sent. Enumerated Values: X = symmetric jaw pair in IEC X direction Y = symmetric jaw pair in IEC Y direction ASYMX = asymmetric jaw pair in IEC X direction ASYMY = asymmetric pair in IEC Y direction MLCX = multileaf (multi-element) jaw pair in IEC X direction MLCY = multileaf (multi-element) jaw pair in IEC Y direction
>>Beam Limiting Device Position Tolerance	(300A,004A)	1C	Maximum permitted difference (in mm) between planned and delivered leaf (element) or jaw positions for current beam limiting device (collimator). Required if Beam Limiting Device Tolerance Sequence (300A,0040) is sent.

>Patient Support Angle Tolerance	(300A,004C)	3	Maximum permitted difference (in degrees) between planned and delivered Patient Support Angle.
>Table Top Eccentric Angle Tolerance	(300A,004E)	3	Maximum permitted difference (in degrees) between planned and delivered Table Top Eccentric Angle.
>Table Top Vertical Position Tolerance	(300A,0051)	3	Maximum permitted difference (in mm) between planned and delivered Table Top Vertical Position.
>Table Top Longitudinal Position Tolerance	(300A,0052)	3	Maximum permitted difference (in mm) between planned and delivered Table Top Longitudinal Position.
>Table Top Lateral Position Tolerance	(300A,0053)	3	Maximum permitted difference (in mm) between planned and delivered Table Top Lateral Position.

Note: Tolerance Tables may be used to compare planned with delivered machine parameters. If the absolute difference between the planned and delivered values exceeds the Tolerance Table value, treatment may be inhibited or the operator may be warned.

C.8.8.12 RT Patient Setup Module

The RT Patient Setup Module contains information describing the positioning of the patient with respect to the treatment machine, along with any fixation devices used. It also describes the shielding devices applied to the patient. The module contains a sequence of patient setup descriptions, each of which may be referenced by one of more beams or brachy application setups.

Table C.8-44—RT PATIENT SETUP MODULE ATTRIBUTES

Attribute Name	Tag	Type	Attribute Description
Patient Setup Sequence	(300A,0180)	1	Introduces sequence of patient setup data for current plan. One or more items may be included in this sequence.
>Patient Setup Number	(300A,0182)	1	Identification number of the Patient Setup. The value of Patient Setup Number (300A,0182) shall be unique within the RT Plan in which it is created.
>Patient Position	(0018,5100)	1C	Patient position descriptor relative to the equipment. Required if Patient Additional Position (300A,0184) is not present. See Section C.7.3.1.1.2 for Defined Terms and further explanation.
>Patient Additional Position	(300A,0184)	1C	User-defined additional description of patient position. Required if Patient Position (0018,5100) is not present.
>Fixation Device Sequence	(300A,0190)	3	Introduces sequence of Fixation Devices used in Patient Setup. One or more items may be included in this sequence.

>>Fixation Device Type	(300A,0192)	1C	Type of Fixation Device used during in Patient Setup. Required if Fixation Device Sequence (300A,0190) is sent. Defined Terms: BITEBLOCK HEADFRAME MASK MOLD CAST HEADREST BREAST_BOARD
>>Fixation Device Label	(300A,0194)	2C	User-defined label identifier for Fixation Device. Required if Fixation Device Sequence (300A,0190) is sent.
>>Fixation Device Description	(300A,0196)	3	User-defined description of Fixation Device.
>>Fixation Device Position	(300A,0198)	3	Position/Notch number of Fixation Device.
>Shielding Device Sequence	(300A,01A0)	3	Introduces sequence of Shielding Devices used in Patient Setup. One or more items may be included in this sequence.
>>Shielding Device Type	(300A,01A2)	1C	Type of Shielding Device used in Patient Setup. Required if Shielding Device Sequence (300A,01A0) is sent. Defined Terms: GUM EYE GONAD
>>Shielding Device Label	(300A,01A4)	2C	User-defined label for Shielding Device. Required if Shielding Device Sequence (300A,01A0) is sent.
>>Shielding Device Description	(300A,01A6)	3	User-defined description of Shielding Device.
>>Shielding Device Position	(300A,01A8)	3	Position/Notch number of Shielding Device.
>Setup Technique	(300A,01B0)	3	Setup Technique used in Patient Setup. Defined Terms: ISOCENTRIC FIXED_SSD TBI BREAST_BRIDGE SKIN_APPOSITION
>Setup Technique Description	(300A,01B2)	3	User-defined description of Setup Technique.

>Setup Device Sequence	(300A,01B4)	3	Introduces sequence of devices used for patient alignment in Patient Setup. One or more items may be included in this sequence.
>>Setup Device Type	(300A,01B6)	1C	Type of Setup Device used for Patient alignment. Required if Setup Device Sequence (300A,01B4) is sent. Defined Terms: LASER_POINTER DISTANCE_METER TABLE_HEIGHT MECHANICAL_PTR ARC
>>Setup Device Label	(300A,01B8)	2C	User-defined label for Setup Device used for patient alignment. Required if Setup Device Sequence (300A,01B4) is sent.
>>Setup Device Description	(300A,01BA)	3	User-defined description for Setup Device used for patient alignment.
>>Setup Device Parameter	(300A,01BC)	2C	Setup Parameter for Setup Device in appropriate IEC 61217 coordinate system. Units shall be mm for distances and angles for degrees. Required if Setup Device Sequence (300A,011B4) is sent.
>>Setup Reference Description	(300A,01D0)	3	User-defined description of Setup Reference used for patient alignment.
>Table Top Vertical Setup Displacement	(300A,01D2)	3	Vertical Displacement in IEC TABLE TOP coordinate system (in mm) relative to initial Setup Position, i.e. vertical offset between patient positioning performed using setup and treatment position.
>Table Top Longitudinal Setup Displacement	(300A,01D4)	3	Longitudinal Displacement in IEC TABLE TOP coordinate system (in mm) relative to initial Setup Position, i.e. longitudinal offset between patient positioning performed using setup and treatment position.
>Table Top Lateral Setup Displacement	(300A,01D6)	3	Lateral Displacement in IEC TABLE TOP coordinate system (in mm) relative to initial Setup Position, i.e. lateral offset between patient positioning performed using setup and treatment position.

C.8.8.13 RT Fraction Scheme Module

The RT Fraction Scheme module contains attributes that describe a single or multiple scheme of dose descriptions. Each sequence item contains dose specification information, fractionation patterns, and either beam or brachytherapy application setup specifications. The design of the RT

Fraction Scheme module allows a beam or brachytherapy application setup to be used in multiple fraction schemes.

Table C.8-45—RT FRACTION SCHEME MODULE ATTRIBUTES

Attribute Name	Tag	Type	Attribute Description
Fraction Group Sequence	(300A,0070)	1	Introduces sequence of Fraction Groups in current Fraction Scheme. One or more items may be included in this sequence.
>Fraction Group Number	(300A,0071)	1	Identification number of the Fraction Group. The value of Fraction Group Number (300A,0071) shall be unique within the RT Plan in which it is created.
>Referenced Patient Setup Number	(300C,006A)	3	Uniquely identifies Patient Setup specified by Patient Setup Number (300A,0182) within Patient Setup Sequence (300A,0180) in RT Patient Setup Module.
>Referenced Dose Sequence	(300C,0080)	3	Introduces sequence of related SOP Class/Instance pairs describing related instances of RT Dose (for grids, isodose curves and named/unnamed point doses). One or more items may be included in this sequence. See Note 1.
>>Referenced SOP Class UID	(0008,1150)	1C	Uniquely identifies the referenced SOP Class. Required if Referenced Dose Sequence (300C,0080) is sent.
>>Referenced SOP Instance UID	(0008,1155)	1C	Uniquely identifies the referenced SOP Instance. Required if Referenced Dose Sequence (300C,0080) is sent.
>Referenced Dose Reference Sequence	(300C,0050)	3	Introduces sequence of Dose References for the current Fraction Group. One or more items may be included in this sequence.
>>Referenced Dose Reference Number	(300C,0051)	1C	Uniquely identifies Dose Reference specified by Dose Reference Number (300A,0012) within Dose Reference Sequence (300A,0010) in RT Prescription Module. Required if Referenced Dose Reference Sequence (300C,0050) is sent.
>>Constraint Weight	(300A,0021)	3	Relative importance of satisfying constraint, where high values represent more important constraints.
>>Delivery Warning Dose	(300A,0022)	3	The dose (in Gy) which when reached or exceeded should cause some action to be taken.
>>Delivery Maximum Dose	(300A,0023)	3	The maximum dose (in Gy) which can be delivered to the dose reference.

>>Target Minimum Dose	(300A,0025)	3	Minimum permitted dose (in Gy) to Dose Reference if Dose Reference Type (300A,0020) of referenced Dose Reference is TARGET.
>>Target Prescription Dose	(300A,0026)	3	Prescribed dose (in Gy) to Dose Reference if Dose Reference Type (300A,0020) of referenced Dose Reference is TARGET.
>>Target Maximum Dose	(300A,0027)	3	Maximum permitted dose (in Gy) to Dose Reference if Dose Reference Type (300A,0020) of referenced Dose Reference is TARGET.
>>Target Underdose Volume Fraction	(300A,0028)	3	Maximum permitted fraction (in percent) of Target to receive less than the Target Prescription Dose (300A,0027) if Dose Reference Type (300A,0020) of referenced Dose Reference is TARGET and Dose Reference Structure Type (300A,0014) of referenced Dose Reference is VOLUME.
>>Organ at Risk Full-volume Dose	(300A,002A)	3	Maximum dose (in Gy) to entire Dose Reference if Dose Reference Type (300A,0020) of referenced Dose Reference is ORGAN_AT_RISK and Dose Reference Structure Type (300A,0014) of referenced Dose Reference is VOLUME.
>>Organ at Risk Limit Dose	(300A,002B)	3	Maximum permitted dose (in Gy) to any part of Dose Reference if Dose Reference Type (300A,0020) of referenced Dose Reference is ORGAN_AT_RISK and Dose Reference Structure Type (300A,0014) of referenced Dose Reference is VOLUME.
>>Organ at Risk Maximum Dose	(300A,002C)	3	Maximum dose (in Gy) to non-overdosed part of Dose Reference if Dose Reference Type (300A,0020) of referenced Dose Reference is ORGAN_AT_RISK and Dose Reference Structure Type (300A,0014) of referenced Dose Reference is VOLUME.
>>Organ at Risk Overdose Volume Fraction	(300A,002D)	3	Maximum permitted fraction (in percent) of Organ at Risk to receive more than the Organ at Risk Maximum Dose if Dose Reference Type (300A,0020) of referenced Dose Reference is ORGAN_AT_RISK and Dose Reference Structure Type (300A,0014) of referenced Dose Reference is VOLUME.
>Number of Fractions Planned	(300A,0078)	2	Total number of treatments (Fractions) prescribed for current Fraction Group.
>Number of Fraction Pattern Digits Per Day	(300A,0079)	3	Number of digits in Fraction Pattern (300A,007B) used to represent one day. See Note 2.

>Repeat Fraction Cycle Length	(300A,007A)	3	Number of weeks needed to describe treatment pattern. See Note 2.
>Fraction Pattern	(300A,007B)	3	String of 0's (no treatment) and 1's (treatment) describing treatment pattern. Length of string is 7 x Number of Fraction Pattern Digits Per Day x Repeat Fraction Cycle Length. Pattern shall start on a Monday. See Note 2.
>Number of Beams	(300A,0080)	1	Number of Beams in current Fraction Group. If Number of Beams is greater then zero, Number of Brachy Application Setups (300A,00A0) shall equal zero.
>Referenced Beam Sequence	(300C,0004)	1C	Introduces sequence of treatment beams in current Fraction Group. Required if Number of Beams (300A,0080) is greater than zero. One or more items may be included in this sequence.
>>Referenced Beam Number	(300C,0006)	1C	Uniquely identifies Beam specified by Beam Number (300A,00C0) within Beam Sequence (300A,00B0) in RT Beams Module. Required if Referenced Beam Sequence (300C,0004) is sent.
>>Beam Dose Specification Point	(300A,0082)	3	Coordinates (x,y,z) of point at which Beam Dose is specified in the patient based coordinate system described in C.7.6.2.1.1 (mm). See Note 3.
>>Beam Dose	(300A,0084)	3	Dose (in Gy) at Beam Dose Specification Point (300A,0082) due to current Beam.
>>Beam Meterset	(300A,0086)	3	Machine setting to be delivered for current Beam, specified in Monitor Units (MU) or minutes as defined by Primary Dosimeter Unit (300A,00B3) (in RT Beams Module) for referenced Beam. See Note 4.
>Number of Brachy Application Setups	(300A,00A0)	1	Number of Brachy Application Setups in current Fraction Group. If Number of Brachy Application Setups is greater then zero, Number of Beams (300A,0080) shall equal zero.
>Referenced Brachy Application Setup Sequence	(300C,000A)	1C	Introduces sequence of treatment Brachy Application Setups in current Fraction Group. Required if Number of Brachy Application Setups (300A,00A0) is greater than zero. One or more items may be included in this sequence.

>>Referenced Brachy Application Setup Number	(300C,000C)	1C	Uniquely identifies Brachy Application Setup specified by Brachy Application Setup Number (300A,0234) within Brachy Application Setup Sequence (300A,0230) in RT Brachy Application Setups Module. Required if Referenced Brachy Application Setup Sequence (300C,000A) is sent.
>>Brachy Application Setup Dose Specification Point	(300A,00A2)	3	Coordinates (x,y,z) of point in the patient based coordinate system described in C.7.6.2.1.1 at which Brachy Application Setup Dose (300A,00A4) is specified (mm).
>>Brachy Application Setup Dose	(300A,00A4)	3	Dose (in Gy) at Brachy Application Setup Dose Specification Point (300A,00A2) due to current Brachy Application Setup.

- Notes:
1. An RT Dose IOD referenced within the Referenced Dose Sequence (300C,0080) can be used for storing grid-based (pixel) data, isodose curves, and/or individual dose points (with optional dose point names) for the current Fraction Group.
 2. The fractionation pattern does not indicate the actual start of treatment, or the order or timing of fraction delivery. If treatment does not commence as outlined in the pattern, it is the application's responsibility to make any necessary adjustments.

Examples of Fractionation Pattern Schemes:

a) 1 fraction group, 1 fraction per day (Monday to Friday):

Number of Fraction Pattern Digits per Day = 1, Repeat Fraction Cycle Length = 1, Fraction Pattern = 1111100

b) 2 fraction groups, 1 fraction per day, first fraction group Monday, Wednesday, and Friday, second fraction group Tuesday and Thursday:

Fraction Group 1: Number of Fraction Pattern Digits Per Day = 1, Repeat Fraction Cycle Length = 1, Fraction Pattern = 1010100

Fraction Group 2: Number of Fraction Pattern Digits Per Day = 1, Repeat Fraction Cycle Length = 1, Fraction Pattern = 0101000

c) 2 fraction groups, 1 fraction per day, alternating fraction groups every day of treatment (Monday to Friday):

Fraction Group 1: Number of Fraction Pattern Digits Per Day = 1, Repeat Fraction Cycle Length = 2, Fraction Pattern = 10101000101000

Fraction Group 2: Number of Fraction Pattern Digits Per Day = 1, Repeat Fraction Cycle Length = 2, Fraction Pattern = 01010001010100

d) 1 fraction group, 2 fractions per day (Monday to Friday):

Fraction Group 1: Number of Fraction Pattern Digits Per Day = 2, Repeat Fraction Cycle Length = 1, Fraction Pattern = 11111111110000

e) 2 fraction groups, 2 fractions per day, alternating fraction groups every treatment (Monday to Friday):

Fraction Group 1: Number of Fraction Pattern Digits Per Day = 1, Repeat Fraction Cycle Length = 1, Fraction Pattern = 1111100

Fraction Group 2: Number of Fraction Pattern Digits Per Day = 2, Repeat Fraction Cycle Length = 1, Fraction Pattern = 11111111110000

3. The Beam Dose Specification Point (300A,0082) and Brachy Application Setup Dose Specification Point (300A,00A2) contain the coordinates of the single point used for dose normalization. This point is distinct from the Referenced Dose Reference Sequence (300C,0050) in the RT Beams module and the Brachy Referenced Dose Reference Sequence (300A,0055) in the RT Brachy Application Setups module, which are used for plan evaluation and dose tracking.

4. The Meterset at a given Control Point (see RT Beams Module) is equal to the Beam Meterset (300A,0086) multiplied by the Cumulative Meterset Weight (300A,0134) for the Control Point, divided by the Final Cumulative Meterset Weight (300A,010E).

C.8.8.14 RT Beams Module

The RT Beams Module contains information defining equipment parameters for delivery of external radiation beams.

Table C.8-46—RT BEAMS MODULE ATTRIBUTES

Attribute Name	Tag	Type	Attribute Description
Beam Sequence	(300A,00B0)	1	Introduces sequence of treatment beams for current RT Plan. One or more items may be included in this sequence.
>Beam Number	(300A,00C0)	1	Identification number of the Beam. The value of Beam Number (300A,00C0) shall be unique within the RT Plan in which it is created. See Note 1.
>Beam Name	(300A,00C2)	3	User-defined name for Beam. See Note 1.
>Beam Description	(300A,00C3)	3	User-defined description for Beam. See Note 1.
>Beam Type	(300A,00C4)	1	Motion characteristic of Beam. See Note 5. Enumerated Values: STATIC = All Control Point Sequence (300A,0111) attributes remain unchanged between consecutive pairs of control points with changing Cumulative Meterset Weight (300A,0134). DYNAMIC = One or more Control Point Sequence (300A,0111) attributes change between one or more consecutive pairs of control points with changing Cumulative Meterset Weight (300A,0134).

>Radiation Type	(300A,00C6)	2	Particle type of Beam. Defined Terms: PHOTON ELECTRON NEUTRON PROTON
>High-Dose Technique Type	(300A,00C7)	1C	Type of high-dose treatment technique. Defined Terms: NORMAL = Standard treatment TBI = Total Body Irradiation HDR = High Dose Rate Required if treatment technique requires a dose that would normally require overriding of treatment machine safety controls.
>Treatment Machine Name	(300A,00B2)	2	User-defined name identifying treatment machine to be used for beam delivery. See Note 2.
>Manufacturer	(0008,0070)	3	Manufacturer of the equipment to be used for beam delivery.
>Institution Name	(0008,0080)	3	Institution where the equipment is located that is to be used for beam delivery.
>Institution Address	(0008,0081)	3	Mailing address of the institution where the equipment is located that is to be used for beam delivery.
>Institutional Department Name	(0008,1040)	3	Department in the institution where the equipment is located that is to be used for beam delivery.
>Manufacturer's Model Name	(0008,1090)	3	Manufacturer's model name of the equipment that is to be used for beam delivery.
>Device Serial Number	(0018,1000)	3	Manufacturer's serial number of the equipment that is to be used for beam delivery.
>Primary Dosimeter Unit	(300A,00B3)	3	Measurement unit of machine dosimeter. See C.8.8.14.1. Enumerated Values: MU = Monitor Unit MINUTE = minute
>Referenced Tolerance Table Number	(300C,00A0)	3	Uniquely identifies Tolerance Table specified by Tolerance Table Number (300A,0042) within Tolerance Table Sequence in RT Tolerance Tables Module. These tolerances are to be used for verification of treatment machine settings.

>Source-Axis Distance	(300A,00B4)	3	Radiation source to Gantry rotation axis distance of the equipment that is to be used for beam delivery (mm).
>Beam Limiting Device Sequence	(300A,00B6)	1	Introduces sequence of beam limiting device (collimator) jaw or leaf (element) sets. One or more items may be included in this sequence.
>>RT Beam Limiting Device Type	(300A,00B8)	1	Type of beam limiting device (collimator). Enumerated Values: X = symmetric jaw pair in IEC X direction Y = symmetric jaw pair in IEC Y direction ASYMX = asymmetric jaw pair in IEC X direction ASYMY = asymmetric pair in IEC Y direction MLCX = multileaf (multi-element) jaw pair in IEC X direction MLCY = multileaf (multi-element) jaw pair in IEC Y direction
>>Source to Beam Limiting Device Distance	(300A,00BA)	3	Radiation source to beam limiting device (collimator) distance of the equipment that is to be used for beam delivery (mm).
>>Number of Leaf/Jaw Pairs	(300A,00BC)	1	Number of leaf (element) or jaw pairs (equal to 1 for standard beam limiting device jaws).
>>Leaf Position Boundaries	(300A,00BE)	2C	Boundaries of beam limiting device (collimator) leaves (in mm) in IEC BEAM LIMITING DEVICE coordinate axis appropriate to RT Beam Limiting Device Type (300A,00B8), i.e. X-axis for MLCY, Y-axis for MLCX. Contains N+1 values, where N is the Number of Leaf/Jaw Pairs (300A,00BC), starting from Leaf (Element) Pair 1. Required if Beam Limiting Device Sequence (300A,00B6) is sent and RT Beam Limiting Device Type (300A,00B8) is MLCX or MLCY. See Note 3.
>Referenced Patient Setup Number	(300C,006A)	3	Uniquely identifies Patient Setup to be used for current beam, specified by Patient Setup Number (300A,0182) within Patient Setup Sequence of RT Patient Setup Module.
>Referenced Reference Image Sequence	(300C,0042)	3	Introduces sequence of reference images used for validation of current beam. One or more items may be included in this sequence.
>>Referenced SOP Class UID	(0008,1150)	1C	Uniquely identifies the referenced SOP Class. Required if Referenced Reference Image Sequence (300C,0042) is sent.

>>Referenced SOP Instance UID	(0008,1155)	1C	Uniquely identifies the referenced SOP Instance. Required if Referenced Reference Image Sequence (300C,0042) is sent.
>>Reference Image Number	(300A,00C8)	1C	Uniquely identifies Reference Image within Referenced Reference Image Sequence (300A,0042). Required if Referenced Reference Image Sequence (300A,0042) is sent.
>>Start Cumulative Meterset Weight	(300C,0008)	3	Cumulative Meterset Weight within current Beam at which image acquisition starts.
>>End Cumulative Meterset Weight	(300C,0009)	3	Cumulative Meterset Weight within current Beam at which image acquisition ends.
>Planned Verification Image Sequence	(300A,00CA)	3	Introduces sequence of planned verification images to be acquired during current beam. One or more items may be included in this sequence. See C.8.8.14.2.
>>Start Cumulative Meterset Weight	(300C,0008)	3	Cumulative Meterset Weight within current Beam at which image acquisition will start.
>>Meterset Exposure	(3002,0032)	3	Meterset duration over which image is to be acquired, specified in Monitor units (MU) or minutes as defined by Primary Dosimeter Unit (300A,00B3).
>>End Cumulative Meterset Weight	(300C,0009)	3	Cumulative Meterset Weight within current Beam at which image acquisition will end.
>>RT Image Plane	(3002,000C)	3	Describes whether or not image plane is normal to beam axis. Enumerated Values: NORMAL = image plane normal to beam axis NON_NORMAL = image plane non-normal to beam axis
>>X-Ray Image Receptor Angle	(3002,000E)	3	X-Ray Image Receptor Angle i.e. orientation of IEC X-RAY IMAGE RECEPTOR coordinate system with respect to IEC GANTRY coordinate system (degrees). See C.8.8.14.3.
>>RT Image Orientation	(3002,0010)	3	The direction cosines of the first row and the first column with respect to the IEC X-RAY IMAGE RECEPTOR coordinate system.
>>RT Image Position	(3002,0012)	3	The x and y coordinates (in mm) of the upper left hand corner (first pixel transmitted) of the image, in the IEC X-RAY IMAGE RECEPTOR coordinate system.
>>RT Image SID	(3002,0026)	3	Radiation machine source to image plane distance (mm).

>>Imaging Device-Specific Acquisition Parameters	(300A,00CC)	3	User-specified device-specific parameters which describe how the imager will acquire the image.
>>Referenced Reference Image Number	(300C,0007)	3	Uniquely identifies Reference Image to which planned verification image is related, specified by Reference Image Number (300A,00C8) within Referenced Reference Image Sequence (300A,0042).
>Treatment Delivery Type	(300A,00CE)	3	Delivery Type of treatment. Defined Terms: TREATMENT = normal patient treatment OPEN_PORTFILM = portal image acquisition with open field TRMT_PORTFILM = portal image acquisition with treatment port CONTINUATION = continuation of interrupted treatment
>Referenced Dose Sequence	(300C,0080)	3	Introduces sequence of related SOP Class/Instance pairs describing related instances of RT Dose (for grids, isodose curves, and named/unnamed point doses). One or more items may be included in this sequence.
>>Referenced SOP Class UID	(0008,1150)	1C	Uniquely identifies the referenced SOP Class. Required if Referenced Dose Sequence (300C,0080) is sent.
>>Referenced SOP Instance UID	(0008,1155)	1C	Uniquely identifies the referenced SOP Instance. Required if Referenced Dose Sequence (300C,0080) is sent.
>Number of Wedges	(300A,00D0)	1	Number of wedges associated with current Beam.
>Wedge Sequence	(300A,00D1)	1C	Introduces sequence of treatment wedges. Required if Number of Wedges (300A,00D0) is non-zero. One or more items may be included in this sequence.
>>Wedge Number	(300A,00D2)	1C	Identification number of the Wedge. The value of Wedge Number (300A,00D2) shall be unique within the Beam in which it is created. Required if Wedge Sequence (300A,00D1) is sent.

>>Wedge Type	(300A,00D3)	2C	Type of wedge (if any) defined for Beam. Required if Wedge Sequence (300A,00D1) is sent. Defined Terms: STANDARD = standard (static) wedge DYNAMIC = moving beam limiting device (collimator) jaw simulating wedge MOTORIZED = single wedge which can be removed from beam remotely
>>Wedge ID	(300A,00D4)	3	User-supplied identifier for Wedge.
>>Wedge Angle	(300A,00D5)	2C	Nominal wedge angle (degrees). Required if Wedge Sequence (300A,00D1) is sent.
>>Wedge Factor	(300A,00D6)	2C	Nominal wedge factor under machine calibration conditions at the beam energy specified by the Nominal Beam Energy (300A,0114) of the first Control Point of the Control Point Sequence (300A,0111). Required if Wedge Sequence (300A,00D1) is sent.
>>Wedge Orientation	(300A,00D8)	2C	Orientation of wedge, i.e. orientation of IEC WEDGE FILTER coordinate system with respect to IEC BEAM LIMITING DEVICE coordinate system (degrees). Required if Wedge Sequence (300A,00D1) is sent.
>>Source to Wedge Tray Distance	(300A,00DA)	3	Radiation source to wedge tray attachment edge distance (in mm) for current wedge.
>Number of Compensators	(300A,00E0)	1	Number of compensators associated with current Beam.
>Total Compensator Tray Factor	(300A,00E2)	3	Compensator Tray transmission factor (between 0 and 1), at the beam energy specified by the Nominal Beam Energy (300A,0114) of the first Control Point of the Control Point Sequence (300A,0111).
>Compensator Sequence	(300A,00E3)	1C	Introduces sequence of treatment compensators. Required if Number of Compensators (300A,00E0) is non-zero. One or more items may be included in this sequence.
>>Compensator Number	(300A,00E4)	1C	Identification number of the Compensator. The value of Compensator Number (300A,00E4) shall be unique within the Beam in which it is created. Required if Number of Compensators (300A,00E0) is non-zero.

>>Compensator Type	(3004,00EE)	3	Type of compensator (if any). Defined Terms: STANDARD = physical (static) compensator DYNAMIC = moving Beam Limiting Device (collimator) simulating physical compensator
>>Material ID	(300A,00E1)	2C	User-supplied identifier for material used to manufacture Compensator. Required if Number of Compensators (300A,00E0) is non-zero.
>>Compensator ID	(300A,00E5)	3	User-supplied identifier for compensator.
>>Source to Compensator Tray Distance	(300A,00E6)	2C	Radiation source to compensator tray attachment edge distance (in mm) for current compensator. Required if Compensator Sequence (300A,00E3) is sent.
>>Compensator Rows	(300A,00E7)	1C	Number of rows in the compensator. Required if Compensator Sequence (300A,00E3) is sent.
>>Compensator Columns	(300A,00E8)	1C	Number of columns in the compensator. Required if Compensator Sequence (300A,00E3) is sent.
>>Compensator Pixel Spacing	(300A,00E9)	1C	Physical distance (in mm) between the center of each pixel projected onto machine isocentric plane. Specified by a numeric pair - adjacent row spacing (delimiter) adjacent column spacing. Required if Compensator Sequence (300A,00E3) is sent.
>>Compensator Position	(300A,00EA)	1C	The x and y coordinates of the upper left hand corner (first pixel transmitted) of the compensator, projected onto the machine isocentric plane in the IEC BEAM LIMITING DEVICE coordinate system (mm). Required if Compensator Sequence (300A,00E3) is sent.

>>Compensator Transmission Data	(300A,00EB)	1C	A data stream of the pixel samples which comprise the compensator, expressed as broad-beam transmission values (between 0 and 1) along a ray line passing through the pixel, at the beam energy specified by the Nominal Beam Energy (300A,0114) of the first Control Point of the Control Point Sequence (300A,0111). The order of pixels sent is left to right, top to bottom, i.e., the upper left pixel is sent first followed by the remainder of the first row , followed by the first pixel of the 2nd row, then the remainder of the 2nd row and so on) when viewed from the radiation source. Required if Compensator Sequence (300A,00E3) is sent and Material ID (300A,00E1) is zero-length.
>>Compensator Thickness Data	(300A,00EC)	1C	A data stream of the pixel samples which comprise the compensator, expressed as thicknesses (in mm) parallel to radiation beam axis. The order of pixels sent is left to right, top to bottom, i.e., the upper left pixel is sent first followed by the remainder of the first row , followed by the first pixel of the 2nd row, then the remainder of the 2nd row and so on) when viewed from the radiation source. Required if Compensator Sequence (300A,00E3) is sent and Material ID (300A,00E1) is non-zero length.
>Number of Boli	(300A,00ED)	1	Number of boli associated with current Beam.
>Referenced Bolus Sequence	(300C,00B0)	1C	Introduces sequence of boli associated with Beam. Required if Number of Boli (300A,00ED) is non-zero. One or more items may be included in this sequence.
>>Referenced ROI Number	(3006,0084)	1C	Uniquely identifies ROI representing the Bolus specified by ROI Number (3006,0022) in Structure Set ROI Sequence (3006,0020) in Structure Set Module within RT Structure Set in Referenced Structure Set Sequence (300C,0060) in RT General Plan Module. Required if Referenced Bolus Sequence (300A,00B0) is sent.
>Number of Blocks	(300A,00F0)	1	Number of shielding blocks associated with Beam.
>Total Block Tray Factor	(300A,00F2)	3	Total block tray transmission for all block trays (between 0 and 1) at the beam energy specified by the Nominal Beam Energy (300A,0114) of the first Control Point of the Control Point Sequence (300A,0111).

>Block Sequence	(300A,00F4)	1C	Introduces sequence of blocks associated with Beam. Required if Number of Blocks (300A,00F0) is non-zero. One or more items may be included in this sequence.
>>Block Tray ID	(300A,00F5)	3	User-supplied identifier for block tray.
>>Source to Block Tray Distance	(300A,00F6)	2C	Radiation Source to attachment edge of block tray assembly (mm). Required if Block Sequence (300A,00F4) is sent.
>>Block Type	(300A,00F8)	1C	Type of block. Required if Block Sequence (300A,00F4) is sent. See C.8.8.14.4. Enumerated Values: SHIELDING = blocking material is inside contour APERTURE = blocking material is outside contour
>>Block Divergence	(300A,00FA)	2C	Indicates presence or otherwise of geometrical divergence. Required if Block Sequence (300A,00F4) is sent. Enumerated Values: PRESENT = block edges are shaped for beam divergence ABSENT = block edges are not shaped for beam divergence
>>Block Number	(300A,00FC)	1C	Identification number of the Block. The value of Block Number (300A,00FC) shall be unique within the Beam in which it is created. Required if Block Sequence (300A,00F4) is sent.
>>Block Name	(300A,00FE)	3	User-defined name for block.
>>Material ID	(300A,00E1)	2C	User-supplied identifier for material used to manufacture Block. Required if Block Sequence (300A,00F4) is sent.
>>Block Thickness	(300A,0100)	2C	Physical thickness of block (in mm) parallel to radiation beam axis. Required if Block Sequence (300A,00F4) is sent and Material ID (300A,00E1) is non-zero length. See C.8.8.14.4.
>>Block Transmission	(300A,0102)	2C	Transmission through the block (between 0 and 1) at the beam energy specified by the Nominal Beam Energy (300A,0114) of the first Control Point of the Control Point Sequence (300A,0111). Required if Block Sequence (300A,00F4) is sent and Material ID (300A,00E1) is zero length. See C.8.8.14.4.

>>Block Number of Points	(300A,0104)	2C	Number of (x,y) pairs defining the block edge. Required if Block Sequence (300A,00F4) is sent.
>>Block Data	(300A,0106)	2C	A data stream of (x,y) pairs which comprise the block edge. The number of pairs shall be equal to Block Number of Points (300A,0104), and the vertices shall be interpreted as a closed polygon. Coordinates are projected onto the machine isocentric plane in the IEC BEAM LIMITING DEVICE coordinate system (mm). Required if Block Sequence (300A,00F4) is sent. See Note 4.
>Applicator Sequence	(300A,0107)	3	Introduces sequence of Applicators associated with Beam. Only a single item shall be permitted in this sequence.
>>Applicator ID	(300A,0108)	1C	User or machine supplied identifier for Applicator. Required if Applicator Sequence (300A,0107) is sent.
>>Applicator Type	(300A,0109)	1C	Type of Applicator. Required if Applicator Sequence (300A,0107) is sent. Defined Terms: ELECTRON_SQUARE = square electron applicator ELECTRON_RECT = rectangular electron applicator ELECTRON_CIRC = circular electron applicator ELECTRON_SHORT = short electron applicator ELECTRON_OPEN = open (dummy) electron applicator INTRAOPERATIVE = intraoperative (custom) applicator STEREOTACTIC = stereotactic applicator
>>Applicator Description	(300A,010A)	3	User-defined description for Applicator.
>Final Cumulative Meterset Weight	(300A,010E)	1C	Value of Cumulative Meterset Weight (300A,0134) for final Control Point in Control Point Sequence (300A,0111). Required if Cumulative Meterset Weight is non-null in Control Points specified within Control Point Sequence (300A,0111). See C.8.8.14.1.
>Number of Control Points	(300A,0110)	1	Number of control points in Beam.

>Control Point Sequence	(300A,0111)	1	Introduces sequence of machine configurations describing treatment beam. Two or more items may be included in this sequence. See C.8.8.14.5 and C.8.8.14.6.
>>Control Point Index	(300A,0112)	1C	Index of current Control Point, starting at 0 for first Control Point. Required if Control Point Sequence (300A, 0111) is sent.
>>Cumulative Meterset Weight	(300A,0134)	2C	Cumulative weight to current control point. Cumulative Meterset Weight for the first item in Control Point Sequence shall always be zero. Cumulative Meterset Weight for the final item in Control Point Sequence shall always be equal to Final Cumulative Meterset Weight. Required if Control Point Sequence (300A,0111) is sent. See C.8.8.14.1.
>>Referenced Dose Reference Sequence	(300C,0050)	3	Introduces a sequence of Dose References for current Beam. One or more items may be included in this sequence.
>>>Referenced Dose Reference Number	(300C,0051)	1C	Uniquely identifies Dose Reference specified by Dose Reference Number (300A,0012) in Dose Reference Sequence (300A,0010) in RT Prescription Module. Required if Referenced Dose Reference Sequence (300C,0050) is sent.
>>>Cumulative Dose Reference Coefficient	(300A,010C)	2C	Coefficient used to calculate cumulative dose contribution from this Beam to the referenced Dose Reference at the current Control Point. Required if Referenced Dose Reference Sequence (300C,0050) is sent. See C.8.8.14.7.
>>Nominal Beam Energy	(300A,0114)	3	Nominal Beam Energy at control point (MV/MeV).
>>Dose Rate Set	(300A,0115)	3	Dose Rate to be set on treatment machine for segment beginning at current control point (e.g. MU/min).
>>Wedge Position Sequence	(300A,0116)	3	Introduces sequence of Wedge positions for current control point. One or more items may be included in this sequence.
>>>Referenced Wedge Number	(300C,00C0)	1C	Uniquely references Wedge described by Wedge Number (300A,00D2) in Wedge Sequence (300A,00D1). Required if Wedge Position Sequence (300A,0116) is sent.

>>>Wedge Position	(300A,0118)	1C	Position of Wedge at current Control Point. Required if Wedge Position Sequence (300A,0116) is sent. Enumerated Values: IN OUT
>>Beam Limiting Device Position Sequence	(300A,011A)	1C	Introduces sequence of beam limiting device (collimator) jaw or leaf (element) positions. Required for first item of Control Point Sequence, or if Beam Limiting Device changes during Beam. One or more items may be included in this sequence.
>>>RT Beam Limiting Device Type	(300A,00B8)	1C	Type of beam limiting device (collimator). The value of this attribute shall correspond to RT Beam Limiting Device Type (300A,00B8) defined in an item of Beam Limiting Device Sequence (300A,00B6). Required if Beam Limiting Device Position Sequence (300A,0116) is sent. Enumerated Values: X = symmetric jaw pair in IEC X direction Y = symmetric jaw pair in IEC Y direction ASYMX = asymmetric jaw pair in IEC X direction ASYMY = asymmetric pair in IEC Y direction MLCX = multileaf (multi-element) jaw pair in IEC X direction MLCY = multileaf (multi-element) jaw pair in IEC Y direction
>>>Leaf/Jaw Positions	(300A,011C)	1C	Positions of beam limiting device (collimator) leaf (element) or jaw pairs (in mm) in IEC BEAM LIMITING DEVICE coordinate axis appropriate to RT Beam Limiting Device Type (300A,00B8), e.g. X-axis for MLCX, Y-axis for MLCY. Contains 2N values, where N is the Number of Leaf/Jaw Pairs (300A,00BC) in Beam Limiting Device Sequence (300A,00B6). Values shall be listed in IEC leaf (element) subscript order 101, 102, ... 1N, 201, 202, ... 2N. Required if Beam Limiting Device Position Sequence (300A,0116) is sent. See Note 2.

>>Gantry Angle	(300A,011E)	1C	Gantry angle of radiation source, i.e. orientation of IEC GANTRY coordinate system with respect to IEC FIXED REFERENCE coordinate system (degrees). Required for first item of Control Point Sequence, or if Gantry Angle changes during Beam.
>>Gantry Rotation Direction	(300A,011F)	1C	Direction of Gantry Rotation when viewing gantry from isocenter, for segment following Control Point. Required for first item of Control Point Sequence, or if Gantry Rotation Direction changes during Beam. See C.8.8.14.8. Enumerated Values: CW = clockwise CC = counter-clockwise NONE = no rotation
>>Beam Limiting Device Angle	(300A,0120)	1C	Beam Limiting Device angle, i.e. orientation of IEC BEAM LIMITING DEVICE coordinate system with respect to IEC GANTRY coordinate system (degrees). Required for first item of Control Point Sequence, or if Beam Limiting Device Angle changes during Beam.
>>Beam Limiting Device Rotation Direction	(300A,0121)	1C	Direction of Beam Limiting Device Rotation when viewing beam limiting device (collimator) from radiation source, for segment following Control Point. Required for first item of Control Point Sequence, or if Beam Limiting Device Rotation Direction changes during Beam. See C.8.8.14.8. Enumerated Values: CW = clockwise CC = counter-clockwise NONE = no rotation
>>Patient Support Angle	(300A,0122)	1C	Patient Support angle, i.e. orientation of IEC PATIENT SUPPORT (turntable) coordinate system with respect to IEC FIXED REFERENCE coordinate system (degrees). Required for first item of Control Point Sequence, or if Patient Support Angle changes during Beam.

>>Patient Support Rotation Direction	(300A,0123)	1C	<p>Direction of Patient Support Rotation when viewing table from above, for segment following Control Point. Required for first item of Control Point Sequence, or if Patient Support Rotation Direction changes during Beam. See C.8.8.14.8.</p> <p>Enumerated Values: CW = clockwise CC = counter-clockwise NONE = no rotation</p>
>>Table Top Eccentric Axis Distance	(300A,0124)	3	<p>Distance (positive) from the IEC PATIENT SUPPORT vertical axis to the IEC TABLE TOP ECCENTRIC vertical axis (mm).</p>
>>Table Top Eccentric Angle	(300A,0125)	1C	<p>Table Top (non-isocentric) angle, i.e. orientation of IEC TABLE TOP ECCENTRIC coordinate system with respect to IEC PATIENT SUPPORT coordinate system (degrees). Required for first item of Control Point Sequence, or if Table Top Eccentric Angle changes during Beam.</p>
>>Table Top Eccentric Rotation Direction	(300A,0126)	1C	<p>Direction of Table Top Eccentric Rotation when viewing table from above, for segment following Control Point. Required for first item of Control Point Sequence, or if Table Top Eccentric Rotation Direction changes during Beam. See C.8.8.14.8.</p> <p>Enumerated Values: CW = clockwise CC = counter-clockwise NONE = no rotation</p>
>>Table Top Vertical Position	(300A,0128)	2C	<p>Table Top Vertical position in IEC TABLE TOP coordinate system (mm). Required for first item of Control Point Sequence, or if Table Top Vertical Position changes during Beam. See C.8.8.14.6.</p>
>>Table Top Longitudinal Position	(300A,0129)	2C	<p>Table Top Longitudinal position in IEC TABLE TOP coordinate system (mm). Required for first item of Control Point Sequence, or if Table Top Longitudinal Position changes during Beam. See C.8.8.14.6.</p>
>>Table Top Lateral Position	(300A,012A)	2C	<p>Table Top Lateral position in IEC TABLE TOP coordinate system (mm). Required for first item of Control Point Sequence, or if Table Top Lateral Position changes during Beam. See C.8.8.14.6.</p>

>>Isocenter Position	(300A,012C)	2C	Isocenter coordinates (x,y,z) in the patient based coordinate system described in C.7.6.2.1.1 (mm). Required for first item of Segment Control Point Sequence, or if Segment Isocenter Position changes during Beam.
>>Surface Entry Point	(300A,012E)	3	Patient surface entry point coordinates (x,y,z) in the patient based coordinate system described in C.7.6.2.1.1 (mm).
>>Source to Surface Distance	(300A,0130)	3	Source to Patient Surface distance (mm).

- Notes:
1. Beam Number (300A,00C0) is provided to link related information across modules, and its value should not be required to have any real-world interpretation. Beam Name (300A, 00C2), a Type 3 attribute, is intended to store the primary beam identifier (often referred to as “field identifier”). Beam Description (300A,00C3), a Type 3 attribute, is intended to store additional beam identifying information (often referred to as “field name”). Equipment supporting both these attributes should state this clearly in the Conformance Statement.
 2. The DICOM standard does not support the transmission of treatment unit modeling information such as depth doses and beam profiles.
 3. Implementors should take note that Leaf Position Boundaries (300A,00BE) are the positions of the mechanical boundaries (projected to the isocentric plane) between beam limiting device (collimator) leaves, fixed for a given beam limiting device (collimator). Leaf/Jaw Positions (300A,011C) are values specific to a given beam control point, specifying the beam limiting device (collimator) leaf (element) openings.
 4. Block coordinates may not be transmitted when such data is not available from the transmitting system. However, the receiving system may not have internal mechanisms to use or store such data. For example, a plan sent from an treatment planning system to a Record and Verify (R&V) system will contain the block data for blocked beams. Subsequent transfer of beam data from the R&V system may omit this data since the R&V system may not have stored it.
 5. Refer to C.8.8.14.5 for examples of STATIC and DYNAMIC Beam Type. Note that beams having Wedge Type = DYNAMIC as the only moving parameter are not considered DYNAMIC according to the definition of Beam Type (300A,00C4).

C.8.8.14.1 Meterset calculations

The Meterset at a given Control Point is equal to the Beam Meterset (300A,0086) specified in the Referenced Beam Sequence (300A,0004) of the RT Fraction Scheme Module, multiplied by the Cumulative Meterset Weight (300A,0134) for the Control Point, divided by the Final Cumulative Meterset Weight (300A,010E). The Meterset is specified in units defined by Primary Dosimeter Unit (300A,00B3). If the calculation for Meterset results in a meterset value which is not an exact multiple of the primary meterset resolution, then the result shall be rounded to the nearest allowed meterset value (i.e. less than a half resolution unit shall be rounded down to the nearest resolution unit, and equal or greater than half a resolution unit shall be rounded up to the nearest resolution unit).

Note also that if Final Cumulative Meterset Weight (300A,010E) is equal to 100, then Cumulative Meterset Weight (300A,0134) becomes equivalent to the percentage of Beam Meterset (300A,0086) delivered at each control point. If Final Cumulative Meterset Weight (300A,010E) is equal to Beam Meterset (300A,0086), then the Cumulative Meterset Weight (300A,0134) at each control point becomes equal to the cumulative Meterset delivered at that control point.

C.8.8.14.2 Planned Verification Image Sequence

The Planned Verification Image Sequence (300A,00CA) contains attributes which describe the planned verification images to be acquired during current beam. The Start Cumulative Meterset Weight (300C,0008) specifies the Cumulative Meterset Weight at which image acquisition is to begin. If Meterset Exposure (3002,0032) is present in a sequence item and End Cumulative Meterset Weight (300C,0009) is not present then a single image shall be acquired using the meterset duration specified in Meterset Exposure (3002,0032). If End Cumulative Meterset Weight (300C,0009) is present in a sequence item and Meterset Exposure (3002,0032) is not present then a single image shall be acquired over the beam delivery from Start Cumulative Meterset Weight (300C,0008) to End Cumulative Meterset Weight (300C,0009). If both Meterset Exposure (3002,0032) and End Cumulative Meterset Weight (300C,0009) are present in a sequence item then images shall be acquired every Meterset Exposure (3002,0032) from Start Cumulative Meterset Weight (300C,0008) to End Cumulative Meterset Weight (300C,0009). No images shall extend past End Cumulative Meterset Weight (300C,0009).

C.8.8.14.3 X-Ray Image Receptor Angle

The X-Ray Image Receptor Angle (3002,000E) specifies the rotation of the image receptor device in the IEC X-RAY IMAGE RECEPTOR PLANE. A positive angle corresponds to a counter-clockwise rotation of the X-Ray Image Receptor as viewed from the radiation source in the IEC GANTRY coordinate system. The normal (non-rotated) value for this parameter is zero degrees.

C.8.8.14.4 Multiple aperture blocks

All blocks with Block Type (300A,00F8) of APERTURE for a given beam shall have equal values of Block Transmission (300A,0102) and/or Block Thickness (300A,0100) if they are specified. The composite aperture shall be evaluated as the union of the individual apertures within a single Block. Shielding block transmission(s) shall be applied multiplicatively after the (composite) aperture has been evaluated.

C.8.8.14.5 Control Point Sequence

The DICOM RT Beams Module uses a single beam model to handle static, arc, and dynamic delivery of external beam radiation by a medical accelerator or gamma beam therapy equipment (cobalt unit). All applicable parameters shall be specified at Control Point 0, with the exception of couch positions (see C.8.8.14.6). All parameters which change at any control point of a given beam shall be specified explicitly at all control points (including those preceding the change). No assumptions are made about the behavior of machine parameters between specified control points, and communicating devices shall agree on this behavior outside the current standard.

Gantry Rotation Direction (300A,011F), Beam Limiting Device Rotation Direction (300A,0121), Patient Support Rotation Direction (300A,0123), and Table Top Eccentric Rotation Direction (300A,0126) are defined as applying to the segment following the control point, and changes to these parameters during treatment may be specified without use of a "non-irradiation" segment. All other Control Point Sequence attributes are defined only at the control point. To unambiguously encode changes in discrete-valued attributes such as Wedge Position (300A,0114) and Nominal Beam Energy (300A,0018), a non-irradiation segment where Cumulative Meterset Weight (300A,0134) does not change, shall be used.

Some examples of beam specification using control points are as follows:

- a) *Static delivery:*
 - Control Point 0:* All applicable treatment parameters defined, Cumulative Meterset Weight = 0
 - Control Point 1:* Cumulative Meterset Weight = 1, no other parameters defined

- b) *Arc delivery:*
Control Point 0: All applicable treatment parameters defined, Cumulative Meterset Weight = 0, Gantry Rotation Direction = *rotation direction*, Gantry Angle = *initial angle*
Control Point 1: Cumulative Meterset Weight = 1, Gantry Rotation Direction = NONE, Gantry Angle = *final angle*
- c) *Dynamic delivery of two equally weighted segments:*
Control Point 0: All applicable treatment parameters defined, Cumulative Meterset Weight = 0
Control Point 1: All changing treatment parameters defined (including those which do not change at this control point), Cumulative Meterset Weight = 0.5
Control Point 2: All changing treatment parameters defined (including those which do not change at this control point), Cumulative Meterset Weight = 1
- d) *Dynamic Delivery of two unequally weighted segments with a step change in table angle:*
Control Point 0: All applicable treatment parameters defined, Patient Support Angle = *initial angle*, Patient Support Rotation Direction = NONE, Cumulative Meterset Weight = 0
Control Point 1: Cumulative Meterset Weight = 0.3, Patient Support Angle = *initial angle*, Patient Support Rotation Direction = *rotation direction*, no other parameters defined
Control Point 2: Cumulative Meterset Weight = 0.3, Patient Support Angle = *new angle*, Patient Support Rotation Direction = NONE, no other parameters defined
Control Point 3: Cumulative Meterset Weight = 1, Patient Support Angle = *new angle*, Patient Support Rotation Direction = NONE, no other parameters defined

C.8.8.14.6 Absolute and relative machine coordinates

All treatment machine parameters except couch translations are specified in absolute machine coordinates as defined by IEC 61217. For the Table Top Vertical Position (300A,0128), Table Top Longitudinal Position (300A,0129), and Table Top Lateral Position (300A,012A), if the first Control Point contains a value of non-zero length, all subsequent Control Point position values are absolute values in their respective coordinate system. If the first Control Point contains a zero-length value, all subsequent Control Point position values are specified relative to the (unknown) initial value.

C.8.8.14.7 Cumulative Dose Reference Coefficient

The Cumulative Dose Reference Coefficient (300A,010C) is the value by which Beam Dose (300A,0084) is multiplied to obtain the dose to the referenced dose reference site at the current control point (and after previous control points have been successfully administered). The Cumulative Dose Reference Coefficient (300A,010C) is by definition zero for the initial control point. The Cumulative Dose Reference Coefficient (300A,010C) of the final control point multiplied by Beam Dose (300A,0084) results in the final dose to the referenced dose reference site for the current beam. Dose calculation for dose reference sites other than points is not well defined.

C.8.8.14.8 Machine rotations

For the machine rotation angles Gantry Angle (300A,011E), Beam Limiting Device Angle (300A,0120), Patient Support Angle (300A,0122), and Table Top Eccentric Angle (300A,0125), rotation direction is specified as clockwise (CW), counter-clockwise (CC), or NONE. The maximum permitted rotation between two Control Points is 360 degrees. Examples:

- a) Gantry Angle moves from 5 degrees to 5 degrees, Gantry Rotation Direction = NONE:
No movement.
- b) Gantry Angle moves from 5 degrees to 5 degrees, Gantry Rotation Direction = CW:

Full clockwise rotation (360 degrees).

- c) Table Angle moves from 170 degrees to 160 degrees, Table Rotation Direction = CC:
Counter-clockwise rotation by 350 degrees (note direction of increasing table angle as defined by IEC 61217).

C.8.8.15 RT Brachy Application Setups Module

The RT Brachy Application Setups Module describes the application of a brachytherapy radiotherapy treatment. It contains one or more sources, each associated with one or more Channels. A Channel is a device by which a source is placed in its intended treatment position or positions. A Channel may consist of a Source Applicator plus a Transfer Tube, a Source Applicator alone, a rigid or flexible linear source, or a seed. A number of Channels (for example applicators, sources or seeds) are generally arranged in an Application Setup which may be considered a "logical" device. It is important not to confuse Application Setup with Applicator. The model used here has been primarily built around the concept of remote afterloading, but extended to support other brachytherapy applications such as manual applicators and molds, seeds, and sources. Additional devices which are not Channels are described as Brachy Accessory Devices. Examples of Accessory Devices include shields, which modify the dose distribution from all sources in the treatment. However, Channel shields modify the dose only for the source(s) in that Channel.

The data in the module are arranged as follows:

Treatment Machine Sequence	<i>;treatment machine information (single item)</i>
Source Sequence	<i>;library of sources used in brachy application</i>
Application Setup Sequence	<i>;one or more applicators, sources, seeds etc</i>
Brachy Accessory Device Sequence	<i>;application level shields etc</i>
Channel Sequence	<i>;applicator, line source(s), seed(s) etc</i>
Channel Shield Sequence	<i>;channel-specific shields</i>
Brachy Control Point Sequence	<i>;mechanism to support individual source dwell times</i>

Table C.8-47—RT BRACHY APPLICATION SETUPS MODULE ATTRIBUTES

Attribute Name	Tag	Type	Attribute Description
Brachy Treatment Technique	(300A,0200)	1	Type of brachytherapy treatment technique. Enumerated Values: INTRALUMENARY INTRACAVITARY INTERSTITIAL CONTACT INTRAVASCULAR PERMANENT See C.8.8.15.1.
Brachy Treatment Type	(300A,0202)	1	Type of brachytherapy treatment. Defined Terms: MANUAL = manually positioned HDR = High dose rate MDR = Medium dose rate LDR = Low dose rate PDR = Pulsed dose rate
Treatment Machine Sequence	(300A,0206)	1	Introduces single item sequence describing treatment machine to be used for treatment delivery. Only one item may be included in this sequence.
>Treatment Machine Name	(300A,00B2)	2	User-defined name identifying treatment machine to be used for treatment delivery.
>Manufacturer	(0008,0070)	3	Manufacturer of the equipment to be used for treatment delivery.
>Institution Name	(0008,0080)	3	Institution where the equipment is located that is to be used for treatment delivery.
>Institution Address	(0008,0081)	3	Mailing address of the institution where the equipment is located that is to be used for treatment delivery.
>Institutional Department Name	(0008,1040)	3	Department in the institution where the equipment is located that is to be used for treatment delivery.
>Manufacturer's Model Name	(0008,1090)	3	Manufacturer's model name of the equipment that is to be used for treatment delivery.
>Device Serial Number	(0018,1000)	3	Manufacturer's serial number of the equipment that is to be used for treatment delivery.
Source Sequence	(300A,0210)	1	Introduces sequence of Sources to be used within Application Setups. One or more items may be included in this sequence.

>Source Number	(300A,0212)	1	Identification number of the Source. The value of Source Number (300A,0212) shall be unique within the RT Plan in which it is created.
>Source Type	(300A,0214)	1	Type of Source. Defined Terms: POINT LINE CYLINDER SPHERE
>Source Manufacturer	(300A,0216)	3	Manufacturer of Source.
>Active Source Diameter	(300A,0218)	3	Diameter of active Source (mm).
>Active Source Length	(300A,021A)	3	Length of active Source (mm).
>Material ID	(300A,00E1)	3	User-supplied identifier for encapsulation material of active Source.
>Source Encapsulation Nominal Thickness	(300A,0222)	3	Nominal thickness of wall of encapsulation (mm).
>Source Encapsulation Nominal Transmission	(300A,0224)	3	Nominal transmission through wall of encapsulation (between 0 and 1).
>Source Isotope Name	(300A,0226)	1	Name of Isotope.
>Source Isotope Half Life	(300A,0228)	1	Half-life of Isotope (days).
>Reference Air Kerma Rate	(300A,022A)	1	Air Kerma Rate in air of Isotope specified at Air Kerma Rate Reference Date (300A,022C) and Air Kerma Rate Reference Time (300A,022E) (in $\mu\text{Gy h}^{-1}$ at 1 m).
>Air Kerma Rate Reference Date	(300A,022C)	1	Reference date of Reference Air Kerma Rate (300A,022A) of Isotope.
>Air Kerma Rate Reference Time	(300A,022E)	1	Reference time of Air Kerma Rate (300A,022A) of Isotope.
Application Setup Sequence	(300A,0230)	1	Introduces sequence of Application Setups for current RT Plan. One or more items may be included in this sequence.

>Application Setup Type	(300A,0232)	1	Type of Application Setup. Defined Terms: FLETCHER_SUIT DELCLOS BLOEDORN JOSLIN_FLYNN CHANDIGARH MANCHESTER HENSCHKE NASOPHARYNGEAL OESOPHAGEAL ENDOBONCHIAL SYED_NEBLETT ENDORECTAL PERINEAL
>Application Setup Number	(300A,0234)	1	Identification number of the Application Setup. The value of Application Setup Number (300A,0234) shall be unique within the RT Plan in which it is created.
>Application Setup Name	(300A,0236)	3	User-defined name for Application Setup.
>Application Setup Manufacturer	(300A,0238)	3	Manufacturer of Application Setup.
>Template Number	(300A,0240)	3	Identification number of the Template. The value of Template Number (300A,0240) shall be unique within the Application Setup in which it is created.
>Template Type	(300A,0242)	3	User-defined type for Template Device.
>Template Name	(300A,0244)	3	User-defined name for Template Device.
>Referenced Reference Image Sequence	(300C,0042)	3	Introduces sequence of reference images used for validation of current Application Setup. One or more items may be included in this sequence.
>>Referenced SOP Class UID	(0008,1150)	1C	Uniquely identifies the referenced SOP Class. Required if Referenced Reference Image Sequence (300C,0042) is sent.
>>Referenced SOP Class Instance	(0008,1155)	1C	Uniquely identifies the referenced SOP Instance. Required if Referenced Reference Image Sequence (300C,0042) is sent.
>Total Reference Air Kerma	(300A,0250)	1	Total Reference Air Kerma for current Application Setup, i.e. the product of Air Kerma Rate of all Sources in all Channels with their respective Channel Times (μGy at 1 m).

>Brachy Accessory Device Sequence	(300A,0260)	3	Introduces sequence of Brachy Accessory Devices associated with current Application Setup. One or more items may be included in this sequence.
>>Brachy Accessory Device Number	(300A,0262)	2C	Identification number of the Brachy Accessory Device. The value of Brachy Accessory Device Number (300A,0262) shall be unique within the Application Setup in which it is created. Required if Brachy Accessory Device Sequence (300A,0260) is sent.
>>Brachy Accessory Device ID	(300A,0263)	2C	User or machine supplied identifier for Brachy Accessory Device. Required if Brachy Accessory Device Sequence (300A,0260) is sent.
>>Brachy Accessory Device Type	(300A,0264)	1C	Type of Brachy Accessory Device. Required if Brachy Accessory Device Sequence (300A,0260) is sent. Defined Terms: SHIELD DILATATION MOLD PLAQUE FLAB
>>Brachy Accessory Device Name	(300A,0266)	3	User-defined name for Brachy Accessory Device.
>>Material ID	(300A,00E1)	3	User-supplied identifier for material of Brachy Accessory Device. See Note.
>> Brachy Accessory Device Nominal Thickness	(300A,026A)	3	Nominal thickness of Brachy Accessory Device (mm).
>> Brachy Accessory Device Nominal Transmission	(300A,026C)	3	Nominal Transmission through Brachy Accessory Device (between 0 and 1).
>>Referenced ROI Number	(3006,0084)	2C	Uniquely identifies ROI representing the Brachy Accessory specified by ROI Number (3006,0022) in Structure Set ROI Sequence (3006,0020) in Structure Set Module within RT Structure Set referenced by Referenced RT Structure Set Sequence (300C,0060) in RT General Plan Module. Required if Brachy Accessory Device Sequence (300A,0260) is sent. See C.8.8.15.2.
>Channel Sequence	(300A,0280)	1	Introduces sequence of Channels for current Application Setup. One or more items may be included in this sequence.
>>Channel Number	(300A,0282)	1	Identification number of the Channel. The value of Channel Number (300A,0282) shall be unique within the Application Setup in which it is created.

>>Channel Length	(300A,0284)	2	Length of Channel (mm). See C.8.8.15.3.
>>Channel Total Time	(300A,0286)	1	Total amount of time between first and final Control Points of the Brachy Control Point Sequence (300A,02D0) for current Channel (sec). Channel Total Time calculation is based upon the Reference Air Kerma Rate (300A,022A) of the Referenced Source Number (300C,000E).
>>Source Movement Type	(300A,0288)	1	Type of Source movement. See C.8.8.15.4. Defined Terms: STEPWISE FIXED OSCILLATING UNIDIRECTIONAL
>>Number of Pulses	(300A,028A)	1C	Number of Pulses per fraction for current Channel. Required if Brachy Treatment Type (300A,0202) is PDR.
>>Pulse Repetition Interval	(300A,028C)	1C	Pulse repetition interval (sec) for current Channel. Required if Brachy Treatment Type (300A,0202) is PDR.
>>Source Applicator Number	(300A,0290)	3	Identification number of the Source Applicator. The value of Source Applicator Number (300A,0290) shall be unique within the Channel in which it is created.
>>Source Applicator ID	(300A,0291)	2C	User or machine supplied identifier for Source Applicator. Required if Source Applicator Number (300A,0290) is sent.
>>Source Applicator Type	(300A,0292)	1C	Type of Source Applicator. Required if Source Applicator Number (300A,0290) is sent. Defined Terms: FLEXIBLE RIGID
>>Source Applicator Name	(300A,0294)	3	User-defined name for Source Applicator.
>>Source Applicator Length	(300A,0296)	1C	Length of Source Applicator (mm), defined as the distance between the connector of the applicator and the distal-most position of the source. Required if Source Applicator Number (300A,0290) is sent.
>>Source Applicator Manufacturer	(300A,0298)	3	Manufacturer of Source Applicator.
>>Material ID	(300A,00E1)	3	User-supplied identifier for material of Source Applicator wall. See Note.
>> Source Applicator Wall Nominal Thickness	(300A,029C)	3	Nominal Thickness of Source Applicator wall (mm).
>> Source Applicator Wall Nominal Transmission	(300A,029E)	3	Nominal Transmission through Source Applicator wall (between 0 and 1).

>>Source Applicator Step Size	(300A,02A0)	1C	Distance of path along channel (in mm) between adjacent (potential) dwell positions. Required if Source Movement Type (300A,0288) is STEPWISE.
>>Referenced ROI Number	(3006,0084)	2C	Uniquely identifies ROI representing the Source Applicator specified by ROI Number (3006,0022) in Structure Set ROI Sequence (3006,0020) in Structure Set Module within RT Structure Set referenced by Referenced RT Structure Set Sequence (300C,0060) in RT General Plan Module. Required if Source Applicator Number (300A,0290) is sent. See C.8.8.15.2.
>>Transfer Tube Number	(300A,02A2)	2	Identification number of the Transfer Tube. The value of Transfer Tube Number (300A,02A2) shall be unique within the Channel in which it is created.
>>Transfer Tube Length	(300A,02A4)	2C	Length of Transfer Tube of current afterloading Channel (mm). Required if value Transfer Tube Number (300A,02A2) is non-null.
>>Channel Shield Sequence	(300A,02B0)	3	Introduces sequence of Channel Shields associated with current Channel. One or more items may be included in this sequence. See C.8.8.15.5.
>>>Channel Shield Number	(300A,02B2)	1C	Identification number of the Channel Shield. The value of Channel Shield Number (300A,02B2) shall be unique within the Channel in which it is created. Required if Channel Shield Sequence (300A,02B0) is sent.
>>>Channel Shield ID	(300A,02B3)	2C	User or machine supplied identifier for Channel Shield. Required if Channel Shield Sequence (300A,02B0) is sent.
>>>Channel Shield Name	(300A,02B4)	3	User-defined name for Channel Shield.
>>>Material ID	(300A,00E1)	3	User-supplied identifier for material of Channel Shield. See Note.
>>>Channel Shield Nominal Thickness	(300A,02B8)	3	Nominal Thickness of Channel Shield (mm).
>>>Channel Shield Nominal Transmission	(300A,02BA)	3	Nominal Transmission of Channel Shield (between 0 and 1).

>>>Referenced ROI Number	(3006,0084)	2C	Uniquely identifies ROI representing the Channel Shield specified by ROI Number (3006,0022) in Structure Set ROI Sequence (3006,0020) in Structure Set Module within RT Structure Set referenced by Referenced RT Structure Set Sequence (300C,0060) in RT General Plan Module. Required if Channel Shield Sequence (300A,02B0) is sent. See C.8.8.15.2.
>>Referenced Source Number	(300C,000E)	1	Uniquely identifies the referenced Source within the Source Sequence (300A,0210) for current Application Setup.
>>Number of Control Points	(300A,0110)	1	Number of control points in Channel. For an N-segment Channel there will be 2N (stepwise movement) or N+1 (continuous movement) control points.
>>Final Cumulative Time Weight	(300A,02C8)	1C	Value of Cumulative Time Weight (300A,02D6) for final Control Point in Brachy Control Point Sequence (300A,02D0). Required if Cumulative Time Weight (300A,02D6) is non-null in Control Points specified within Brachy Control Point Sequence (300A,02D0). See C.8.8.15.6.
>>Brachy Control Point Sequence	(300A,02D0)	1	Introduces sequence of machine configurations describing this Channel. Two or more items may be included in this sequence. See C.8.8.15.7.
>>>Control Point Index	(300A,0112)	1	Index of current Control Point, starting at 0 for first Control Point.
>>>Cumulative Time Weight	(300A,02D6)	2	Cumulative time weight to current Control Point (where the weighting is proportional to time values delivered). Cumulative Time Weight for first item in Brachy Control Point Sequence (300A,02D0) is always zero. See C.8.8.15.6 and C.8.8.15.8.
>>>Control Point Relative Position	(300A,02D2)	1	Distance between current Control Point Position and the distal-most possible Source position in current Channel (mm). See C.8.8.15.9.
>>>Control Point 3D Position	(300A,02D4)	3	Coordinates (x, y, z) of Control Point in the patient based coordinate system described in C.7.6.2.1.1 (mm). See C.8.8.15.10.
>>>Brachy Referenced Dose Reference Sequence	(300C,0055)	3	Introduces a sequence of Dose References for current Channel. One or more items may be included in this sequence.

>>>>Referenced Dose Reference Number	(300C,0051)	1C	Uniquely identifies Dose Reference described in Dose Reference Sequence. (300A,0010) within RT Prescription Module of current RT Plan. Required if Brachy Referenced Dose Reference Sequence (300C,0055) is sent.
>>>>Cumulative Dose Reference Coefficient	(300A,010C)	1C	Coefficient used to calculate cumulative dose contribution from this Source to the referenced Dose Reference at the current Control Point. Required if Brachy Referenced Dose Reference Sequence (300C,0055) is sent. See C.8.8.15.11.

Note: Material ID (300A,00E1) may also be specified within a referenced ROI, if an ROI is used to describe the object.

C.8.8.15.1 Permanent Implants

In permanent implant techniques the value for Channel Total Time (300A,0286) shall be mean life time of the isotope. The Brachy Control Point Sequence (300A,02D0) shall consist of two items: the first having Cumulative Time Weight (300A,02D6) = 0 and the second having Cumulative Time Weight (300A,02D6) = Final Cumulative Time Weight (300A,02C8).

C.8.8.15.2 Referenced ROI Number

The Structure Set ROI shall be used in the Brachy Application Setups Module to describe the 3D coordinates of Accessory Devices, Applicators and Channel Shields, but not individual source positions (see C.8.8.15.9 and C.8.8.15.10).

C.8.8.15.3 Channel Length

If specified, the Channel Length (300A,0284) shall be the sum of the Source Applicator Length (300A,0296) and Transfer Tube Length (300A,02A4).

C.8.8.15.4 Oscillating source movement

In brachytherapy treatment techniques involving oscillating source movement (i.e. when Source Movement Type (300A,0288) is OSCILLATING), the Brachy Control Point Sequence (300A,02D0) shall consist of two items. The first Control Point shall have Cumulative Time Weight (300A,02D6) = 0, and Control Point Relative Position (300A,02D2) equal to one end point of the oscillation. The second Control Point shall have Cumulative Time Weight (300A,02D6) = Final Cumulative Time Weight (300A,02C8), and Control Point Relative Position (300A,02D2) equal to the other end point of the oscillation. Transit time shall not be modeled explicitly for oscillating techniques.

C.8.8.15.5 Channel shields

The effect of Channel Shields on dose contributions shall be specific to the Channel for which they are specified. There shall be no effect of these shields on the dose contributions from any other Channels.

C.8.8.15.6 Time calculations

The treatment time at a given Control Point is equal to the Channel Total Time (300A,0286), multiplied by the Cumulative Time Weight (300A,02D6) for the Control Point, divided by the Final Cumulative Time Weight (300A,02C8). If the calculation for treatment time results in a time value which is not an exact multiple of the timer resolution, then the result shall be rounded to the nearest

allowed timer value (i.e. less than a half resolution unit shall be rounded down to the nearest resolution unit, and equal or greater than half a resolution unit shall be rounded up to the nearest resolution unit).

Note also that if Final Cumulative Time Weight (300A,02C8) is equal to 100, then Cumulative Time Weight (300A,02D6) becomes equivalent to the percentage of Channel Total Time (300A,0286) delivered at each control point. If Final Cumulative Time Weight (300A,02C8) is equal to Channel Total Time (300A,0286), then the Cumulative Time Weight (300A,02D6) at each control point becomes equal to the cumulative treatment time delivered at that control point.

If Treatment Type (300A,0202) is PDR, then the Channel Total Time (3008,0286) shall specify the duration of a single pulse.

C.8.8.15.7 Brachy Control Point Sequence

The Control Points shall be arranged such that the first Control Point for a particular Channel describes the first dwell position and the final Control Point for the Channel describes the final dwell position. If Brachy Treatment Type (300A,0202) is PDR, the Brachy Control Point Sequence (300A,02D0) shall specify the sequence of machine configurations for a single pulse. Similarly, if Source Movement Type (300A,0288) is OSCILLATING, the Brachy Control Point Sequence (300A,02D0) shall specify the sequence of machine configurations for a single period.

Some examples of Brachytherapy specification using control points are as follows:

a) Stepwise motion; Four equally weighted dwell positions; Step size = 10; Final Cumulative Time Weight = 100:

Control Point 0:	Control Point Relative Position = 30, Cumulative Time Weight = 0
Control Point 1:	Control Point Relative Position = 30, Cumulative Time Weight = 25
Control Point 2:	Control Point Relative Position = 20, Cumulative Time Weight = 25
Control Point 3:	Control Point Relative Position = 20, Cumulative Time Weight = 50
Control Point 4:	Control Point Relative Position = 10, Cumulative Time Weight = 50
Control Point 5:	Control Point Relative Position = 10, Cumulative Time Weight = 75
Control Point 6:	Control Point Relative Position = 0, Cumulative Time Weight = 75
Control Point 7:	Control Point Relative Position = 0, Cumulative Time Weight = 100

b) Fixed (manually placed) sources; Final Cumulative Time Weight = 100:

Control Point 0:	Control Point Relative Position = 0, Control Point 3D Position = (x,y,z), Cumulative Time Weight = 0
Control Point 1:	Control Point Relative Position = 0, Control Point 3D Position = (x,y,z), Cumulative Time Weight = 100

c) Oscillating movement; Final Cumulative Time Weight = 100:

Control Point 0:	Control Point Relative Position = 100, Cumulative Time Weight = 0
Control Point 1:	Control Point Relative Position = 0, Cumulative Time Weight = 100

d) Unidirectional movement; Final Cumulative Time Weight = 100:

Control Point 0: Control Point Relative Position = 0, Cumulative Time Weight = 0
Control Point 1: Control Point Relative Position = 100, Cumulative Time Weight = 100

e) Stepwise motion with consideration of source transit times between dwell positions; Three equally weighted dwell positions; Step size = 10; Final Cumulative Time Weight = 79:

Control Point 0: Control Point Relative Position = 30, Cumulative Time Weight = 0
Control Point 1: Control Point Relative Position = 30, Cumulative Time Weight = 25
Control Point 2: Control Point Relative Position = 20, Cumulative Time Weight = 27
Control Point 3: Control Point Relative Position = 20, Cumulative Time Weight = 52
Control Point 4: Control Point Relative Position = 10, Cumulative Time Weight = 54
Control Point 5: Control Point Relative Position = 10, Cumulative Time Weight = 79

f) Stepwise motion with consideration of source transit times between dwell positions and to first and from last dwell position; Three equally weighted dwell positions; Step size = 10; Final Cumulative Time Weight = 383:

Control Point 0: Control Point Relative Position = 1200, Cumulative Time Weight = 0
Control Point 1: Control Point Relative Position = 30, Cumulative Time Weight = 150
Control Point 2: Control Point Relative Position = 30, Cumulative Time Weight = 175
Control Point 3: Control Point Relative Position = 20, Cumulative Time Weight = 177
Control Point 4: Control Point Relative Position = 20, Cumulative Time Weight = 202
Control Point 5: Control Point Relative Position = 10, Cumulative Time Weight = 204
Control Point 6: Control Point Relative Position = 10, Cumulative Time Weight = 229
Control Point 7: Control Point Relative Position = 1200, Cumulative Time Weight = 383

C.8.8.15.8 Source transit time

The Source transit times between dwell positions of a remote afterloader may be considered by specifying a non-zero increment in the Cumulative Time Weight (300A,02D6) when the Source moves between Control Points. In this case the Channel Total Time (300A,0286) shall include the overall Source transit time for the Channel.

C.8.8.15.9 Control Point Relative Position

Control Point Relative Position (300A,02D2) shall describe where a given source in a channel is located with respect to the end of the channel. This position shall correspond to the end of the afterloader applicator, *not* the “safe position”.

C.8.8.15.10 Control Point 3D Position

Control Point 3D Position (300A,02D4) shall describe the absolute 3D coordinates of a source. This position shall correspond to the *center* of a source in an applicator during a remote or manually controlled afterloading treatment.

C.8.8.15.11 Cumulative Dose Reference Coefficient

The Cumulative Dose Reference Coefficient (300A,010C) is the value by which Brachy Application Setup Dose (300A,00A4) is multiplied to obtain the dose to the referenced dose reference site at the current control point (and after previous control points have been successfully administered). The Cumulative Dose Reference Coefficient (300A,010C) is by definition zero for the initial control point. The Cumulative Dose Reference Coefficient (300A,010C) of the final control point multiplied by Brachy Application Setup Dose (300A,00A4) results in the final dose to the referenced dose

reference site for the current channel. Dose calculation for dose reference sites other than points is not well defined.

If Treatment Type (300A,0202) is PDR, then the Cumulative Dose Reference Coefficient (3008,010C) shall specify the dose delivered to the dose reference during a single pulse. The total dose delivered to the dose reference shall then be expressed by Cumulative Dose Reference Coefficient (3008,010C) multiplied by Number of Pulses (300A,028A) multiplied by Brachy Application Setup Dose (300A,00A4).

C.8.8.16 Approval Module

Table C.8-48—APPROVAL MODULE ATTRIBUTES

Attribute Name	Tag	Type	Attribute Description
Approval Status	(300E,0002)	1	Approval status at the time the SOP Instance was created. Enumerated Values: APPROVED = Reviewer recorded that object met an implied criterion UNAPPROVED = No review of object has been recorded REJECTED = Reviewer recorded that object failed to meet an implied criterion
Review Date	(300E,0004)	2C	Date on which object was reviewed. Required if Approval Status (300E,0002) is APPROVED or REJECTED.
Review Time	(300E,0005)	2C	Time at which object was reviewed. Required if Approval Status (300E,0002) is APPROVED or REJECTED.
Reviewer Name	(300E,0008)	2C	Name of person who reviewed object. Required if Approval Status (300E,0002) is APPROVED or REJECTED.

C.8.8.17 RT General Treatment Record Module

Table C.8-49—RT GENERAL TREATMENT RECORD MODULE ATTRIBUTES

Attribute Name	Tag	Type	Attribute Description
Instance Number	(0020,0013)	1	Instance number identifying this particular instance of the object.
Treatment Date	(3008,0250)	2	Date when current fraction was delivered, or Date last fraction was delivered in case of RT Treatment Summary Record IOD. See Note.
Treatment Time	(3008,0251)	2	Time when current fraction was delivered (begun), or Time last fraction was delivered (begun) in case of RT Treatment Summary Record IOD. See Note.

Referenced RT Plan Sequence	(300C,0002)	2	A sequence which provides reference to a RT Plan SOP Class/Instance pair. Only a single Item shall be permitted in this Sequence.
>Referenced SOP Class UID	(0008,1150)	1C	Uniquely identifies the referenced SOP Class. Required if Referenced RT Plan Sequence (300C,0002) is sent.
>Referenced SOP Instance UID	(0008,1155)	1C	Uniquely identifies the referenced SOP Instance. Required if Referenced RT Plan Sequence (300C,0002) is sent.
Referenced Treatment Record Sequence	(3008,0030)	3	A sequence which provides reference to RT Treatment Record SOP Class/Instance pairs to which the current RT Treatment Record is significantly related. The sequence may contain one or more items.
>Referenced SOP Class UID	(0008,1150)	1C	Uniquely identifies the referenced SOP Class. Required if Referenced Treatment Record Sequence (3008,0030) is sent.
>Referenced SOP Instance UID	(0008,1155)	1C	Uniquely identifies the referenced SOP Instance. Required if Referenced Treatment Record Sequence (3008,0030) is sent.

Note: Treatment Date (3008,0250) and Treatment Time (3008,0251) can be used to chronologically order a sequence of treatments, where each treatment is represented by an instance of a RT Beams Treatment Record or RT Brachy Treatment Record. In the case of a RT Treatment Summary Record, it can be used to identify the period for which the treatment summary is valid. Therefore, implementers are strongly advised to include values for these attributes whenever possible.

C.8.8.18 RT Treatment Machine Record Module

Table C.8-50—RT TREATMENT MACHINE RECORD MODULE ATTRIBUTES

Attribute Name	Tag	Type	Attribute Description
Treatment Machine Sequence	(300A,0206)	1	Introduces sequence describing treatment machine used for treatment delivery. Only a single Item shall be permitted in this Sequence.
>Treatment Machine Name	(300A,00B2)	2	User-defined name identifying treatment machine used for treatment delivery.
>Manufacturer	(0008,0070)	2	Manufacturer of the equipment used for treatment delivery.
>Institution Name	(0008,0080)	2	Institution where the equipment is located that was used for treatment delivery.
>Institution Address	(0008,0081)	3	Mailing address of the institution where the equipment is located that was used for treatment delivery.

>Institutional Department Name	(0008,1040)	3	Department in the institution where the equipment is located that was used for treatment delivery.
>Manufacturer's Model Name	(0008,1090)	2	Manufacturer's model name of the equipment used for treatment delivery.
>Device Serial Number	(0018,1000)	2	Manufacturer's serial number of the equipment used for treatment delivery.

C.8.8.19 Measured Dose Reference Record Module

Table C.8-51—MEASURED DOSE REFERENCE RECORD MODULE ATTRIBUTES

Attribute Name	Tag	Type	Attribute Description
Measured Dose Reference Sequence	(3008,0010)	1	Introduces sequence of doses measured during treatment delivery, summed over entire session. The sequence may contain one or more items.
>Referenced Dose Reference Number	(300C,0051)	1C	Uniquely identifies Dose Reference specified by Dose Reference Number (300A,0012) in Dose Reference Sequence (300A,0010) in RT Prescription Module of referenced RT Plan. Required only if Measured Dose Reference Number (3008,0064) is not sent. It shall not be present otherwise.
>Measured Dose Reference Number	(3008,0064)	1C	Unique identifier of measured dose point. Required only if Referenced Dose Reference Number (300C,0051) is not sent. It shall not be present otherwise.
>Dose Units	(3004,0002)	1	Units used to describe measured dose. Enumerated Values: GY = Gray RELATIVE = Dose relative to implicit reference value
>Measured Dose Value	(3008,0016)	2	Measured Dose in units specified by Dose Units (3004, 0002).
>Measured Dose Type	(3008,0014)	2	Type of dose measurement. Defined Terms: DIODE = semiconductor diode TLD = thermoluminescent dosimeter ION_CHAMBER = ion chamber GEL = dose sensitive gel EPID = electronic portal imaging device FILM = dose sensitive film
>Measured Dose Description	(3008,0012)	3	User-defined description of Dose Reference (e.g. "Exit dose", "Point A").

C.8.8.20 Calculated Dose Reference Record Module

Table C.8-52—CALCULATED DOSE REFERENCE RECORD MODULE ATTRIBUTES

Attribute Name	Tag	Type	Attribute Description
Calculated Dose Reference Sequence	(3008,0070)	1	Introduces sequence of doses estimated for each treatment delivery. The sequence may contain one or more items.
>Referenced Dose Reference Number	(300C,0051)	1C	Uniquely identifies Dose Reference specified by Dose Reference Number (300A, 0012) in Dose Reference Sequence (300A, 0010) in RT Prescription Module of referenced RT Plan. Required only if Calculated Dose Reference Number (3008,0072) is not sent. It shall not be present otherwise.
>Calculated Dose Reference Number	(3008,0072)	1C	Unique identifier of dose reference point within RT Treatment Record IOD. Required only if Referenced Dose Reference Number (300C,0051) is not sent. It shall not be present otherwise.
>Calculated Dose Reference Dose Value	(3008,0076)	2	Calculated Dose (Gy).
>Calculated Dose Reference Description	(3008,0074)	3	User-defined description of Calculated Dose Reference.

C.8.8.21 RT Beams Session Record Module

Table C.8-53—RT BEAMS SESSION RECORD MODULE ATTRIBUTES

Attribute Name	Tag	Type	Attribute Description
Operator Name	(0008,1070)	2	Name of operator administering treatment session.
Referenced Fraction Group Number	(300C,0022)	3	Identifier of Fraction Group within referenced RT Plan.
Number of Fractions Planned	(300A,0078)	2	Total number of treatments (Fractions) planned for current Fraction Group.
Primary Dosimeter Unit	(300A,00B3)	1	Measurement unit of machine dosimeter. Enumerated Values: MU = Monitor Unit MINUTE = minute
Treatment Session Beam Sequence	(3008,0020)	1	Introduces sequence of Beams administered during treatment session. The sequence may contain one or more items.
>Referenced Beam Number	(300C,0006)	3	References Beam specified by Beam Number (300A,00C0) in Beam Sequence (300A,00B0) in RT Beams Module within referenced RT Plan.
>Beam Name	(300A,00C2)	3	User-defined name for delivered Beam.

>Beam Description	(300A,00C3)	3	User-defined description for delivered Beam.
>Beam Type	(300A,00C4)	1	Motion characteristic of delivered Beam. Enumerated Values: STATIC = all beam parameters remain unchanged during delivery DYNAMIC = one or more beam parameters changes during delivery
>Radiation Type	(300A,00C6)	1	Particle type of delivered Beam. Defined Terms: PHOTON, ELECTRON, NEUTRON, PROTON.
>High-Dose Technique Type	(300A,00C7)	1C	Type of high-dose treatment technique. Defined Terms: NORMAL = Standard treatment TBI = Total Body Irradiation HDR = High Dose Rate Required if treatment technique requires a dose that would normally require overriding of treatment machine safety controls.
>Referenced Verification Image Sequence	(300C,0040)	3	Introduces sequence of verification images obtained during delivery of current beam. The sequence may contain one or more items.
>>Referenced SOP Class UID	(0008,1150)	1C	Uniquely identifies the referenced SOP Class. Required if Referenced Verification Image Sequence (300C,0040) is sent.
>>Referenced SOP Instance UID	(0008,1155)	1C	Uniquely identifies the referenced SOP Instance. Required if Referenced Verification Image Sequence (300C,0040) is sent.
>>Start Meterset	(3008,0078)	3	Cumulative Meterset Weight within Beam referenced by Referenced Beam Number at which image acquisition starts.
>>End Meterset	(3008,007A)	3	Cumulative Meterset Weight within Beam referenced by Referenced Beam Number at which image acquisition ends.
>Referenced Measured Dose Reference Sequence	(3008,0080)	3	Introduces sequence of doses measured during treatment delivery for current Beam. The sequence may contain one or more items.

>>Referenced Dose Reference Number	(300C,0051)	1C	Uniquely references Dose Reference specified by Dose Reference Number (300A,0012) in Dose Reference Sequence (300A,0010) in RT Prescription Module of referenced RT Plan. Required if Referenced Measured Dose Reference Sequence (3008,0080) is sent and Referenced Measured Dose Reference Number (3008,0082) is not sent. It shall not be present otherwise.
>>Referenced Measured Dose Reference Number	(3008,0082)	1C	Uniquely references Measured Dose Reference specified by Measured Dose Reference Number (3008,0064) in Measured Dose Reference Sequence (3008,0010). Required if Referenced Measured Dose Reference Sequence (3008,0080) is sent and Referenced Dose Reference Number (300C, 0051) is not sent. It shall not be present otherwise.
>>Measured Dose Value	(3008,0016)	1C	Measured Dose in units specified by Dose Units (3004,0002) in sequence referenced by Measured Dose Reference Sequence (3008,0010) or Dose Reference Sequence (300A,0010) in RT Prescription Module of referenced RT Plan as defined above. Required if Referenced Measured Dose Reference Sequence (3008,0080) is sent.
>Referenced Calculated Dose Reference Sequence	(3008,0090)	3	Introduces sequence of doses estimated for each treatment delivery. The sequence may contain one or more items.
>>Referenced Dose Reference Number	(300C,0051)	1C	Uniquely identifies Dose Reference specified by Dose Reference Number (300A, 0012) in Dose Reference Sequence (300A, 0010) in RT Prescription Module of referenced RT Plan. Required if Referenced Calculated Dose Reference Sequence (3008,0090) is sent and Referenced Calculated Dose Reference Number (3008,0092) is not sent.
>>Referenced Calculated Dose Reference Number	(3008,0092)	1C	Uniquely identifies Calculated Dose Reference specified by Calculated Dose Reference Number (3008,0072) within Calculated Dose Reference Sequence (3008,0070). Required if Referenced Calculated Dose Reference Sequence (3008,0090) is sent and Referenced Dose Reference Number (300C,0051) is not sent.
>>Calculated Dose Reference Dose Value	(3008,0076)	1C	Calculated Dose (Gy). Required if Referenced Calculated Dose Reference Sequence (3008,0090) is sent.

>Source-Axis Distance	(300A,00B4)	3	Radiation source to gantry rotation axis distance of the equipment that was used for beam delivery (mm).
>Beam Limiting Device Leaf Pairs Sequence	(3008,00A0)	1	Introduces sequence of beam limiting device (collimator) jaw or leaf (element) leaf pair values. The sequence may contain one or more items.
>>RT Beam Limiting Device Type	(300A,00B8)	1	Type of beam limiting device (collimator). Enumerated Values: X = symmetric jaw pair in IEC X direction Y = symmetric jaw pair in IEC Y direction ASYMX = asymmetric jaw pair in IEC X direction ASYMY = asymmetric pair in IEC Y direction MLCX = multileaf (multi-element) jaw pair in IEC X direction MLCY = multileaf (multi-element) jaw pair in IEC Y direction
>>Number of Leaf/Jaw Pairs	(300A,00BC)	1	Number of leaf (element) or jaw pairs (equal to 1 for standard beam limiting device jaws).
>Referenced Patient Setup Number	(300C,006A)	3	Uniquely identifies Patient Setup used within current beam, specified by Patient Setup Number (300A, 0182) within Patient Setup Sequence (300A, 0180) of RT Treatment Record.
>Number of Wedges	(300A,00D0)	1	Number of wedges associated with current delivered Beam.
>Recorded Wedge Sequence	(3008,00B0)	1C	Introduces sequence of treatment wedges present during delivered Beam. Required if Number of Wedges (300A,00D0) is non-zero. The sequence may contain one or more items.
>>Wedge Number	(300A,00D2)	3	Identification number of the Wedge. The value of Wedge Number (300A,00D2) shall be unique within the wedge sequence.

>>Wedge Type	(300A,00D3)	2C	Type of wedge defined for delivered Beam. Required if Recorded Wedge Sequence (3008,00B0) is sent. Defined Terms: STANDARD = standard (static) wedge DYNAMIC = moving Beam Limiting Device (collimator) jaw simulating wedge MOTORIZED = single wedge which can be removed from beam remotely
>>Wedge ID	(300A,00D4)	3	User-supplied identifier for wedge.
>>Wedge Angle	(300A,00D5)	3	Nominal wedge angle delivered (degrees).
>>Wedge Orientation	(300A,00D8)	3	Orientation of wedge, i.e. orientation of IEC WEDGE FILTER coordinate system with respect to IEC BEAM LIMITING DEVICE coordinate system (degrees).
>Number of Compensators	(300A,00E0)	2	Number of compensators associated with current delivered Beam.
>Recorded Compensator Sequence	(3008,00C0)	3	Introduces sequence of treatment compensators associated with current Beam. The sequence may contain one or more items.
>>Referenced Compensator Number	(300C,00D0)	1C	Uniquely identifies compensator specified by Compensator Number (300A,00E4) within Beam referenced by Referenced Beam Number (300C,0006). Required if Recorded Compensator Sequence (3008,00C0) is sent.
>>Compensator Type	(300A,00EE)	2C	Type of compensator (if any). Required if Recorded Compensator Sequence (3008,00C0) is sent. Defined Terms: STANDARD = physical (static) compensator DYNAMIC = moving Beam Limiting Device (collimator) simulating compensator
>>Compensator ID	(300A,00E5)	3	User-supplied identifier for compensator.
>Number of Boli	(300A,00ED)	2	Number of boli used with current Beam.
>Referenced Bolus Sequence	(300C,00B0)	3	Introduces sequence of boli associated with Beam. The sequence may contain one or more items.

>>Referenced ROI Number	(3006,0084)	1C	Uniquely identifies ROI representing the bolus specified by ROI Number (3006,0022) in Structure Set ROI Sequence (3006,0020) in Structure Set Module within RT Structure Set IOD referenced by referenced RT Plan in Referenced RT Plan Sequence (300C,0002) in RT General Treatment Record Module. Required if Referenced Bolus Sequence (300C,00B0) is sent.
>Number of Blocks	(300A,00F0)	2	Number of shielding blocks or Electron Inserts associated with Beam.
>Recorded Block Sequence	(3008,00D0)	3	Introduces sequence of blocks associated with current Beam. The sequence may contain one or more items.
>>Block Tray ID	(300A,00F5)	3	User-supplied identifier for block tray or Electron Insert.
>>Referenced Block Number	(300C,00E0)	3	Uniquely identifies block specified by Block Number (300A,00FC) within Beam referenced by Referenced Beam Number (300C,0006).
>>Block Name	(300A,00FE)	2C	User-defined name for block. Required if Recorded Block Sequence (3008,00D0) is sent.
>Applicator Sequence	(300A,0107)	3	Introduces sequence of Applicators associated with Beam. Only a single item shall be permitted in this sequence.
>>Applicator ID	(300A,0108)	1C	User or machine supplied identifier for Applicator. Required if Applicator Sequence (300A,0107) is sent.
>>Applicator Type	(300A,0109)	1C	Type of Applicator. Required if Applicator Sequence (300A,0107) is sent. Defined Terms: ELECTRON_SQUARE = square electron applicator ELECTRON_RECT = rectangular electron applicator ELECTRON_CIRC = circular electron applicator ELECTRON_SHORT = short electron applicator ELECTRON_OPEN = open (dummy) electron applicator INTRAOPERATIVE = intraoperative (custom) applicator STEREOTACTIC = stereotactic applicator
>>Applicator Description	(300A,010A)	3	User-defined description for Applicator.

>Current Fraction Number	(3008,0022)	2	Fraction number for this beam administration.
>Treatment Delivery Type	(300A,00CE)	2	Delivery Type of treatment. Defined Terms: TREATMENT = normal patient treatment OPEN_PORTFILM = portal image acquisition with open field TRMT_PORTFILM = portal image acquisition with treatment port CONTINUATION = continuation of interrupted treatment
>Treatment Termination Status	(3008,002A)	1	Conditions under which treatment was terminated. Enumerated Values: NORMAL = treatment terminated normally OPERATOR = operator terminated treatment MACHINE = machine terminated treatment UNKNOWN = status at termination unknown
>Treatment Termination Code	(3008,002B)	3	Treatment machine termination code. This code is dependent upon the particular application and equipment.
>Treatment Verification Status	(3008,002C)	2	Conditions under which treatment was verified by a verification system. Enumerated Values: VERIFIED = treatment verified VERIFIED_OVR = treatment verified with at least one out-of-range value overridden NOT_VERIFIED = treatment verified manually
>Specified Primary Meterset	(3008,0032)	3	Desired machine setting of primary meterset.
>Specified Secondary Meterset	(3008,0033)	3	Desired machine setting of secondary meterset.
>Delivered Primary Meterset	(3008,0036)	3	Machine setting actually delivered as recorded by primary meterset.
>Delivered Secondary Meterset	(3008,0037)	3	Machine setting actually delivered as recorded by secondary meterset.
>Specified Treatment Time	(3008,003A)	3	Treatment Time set (sec).
>Delivered Treatment Time	(3008,003B)	3	Treatment Time actually delivered (sec).
>Number of Control Points	(300A,0110)	1	Number of control points delivered.

>Control Point Delivery Sequence	(3008,0040)	1	Introduces sequence of beam control points for current treatment beam. The sequence may contain one or more items. See C.8.8.21.1.
>>Referenced Control Point Index	(300C,00F0)	3	Uniquely identifies Control Point specified by Control Point Index (300A,0112) within Beam referenced by Referenced Beam Number (300C,0006).
>>Treatment Control Point Date	(3008,0024)	1	Date administration of treatment beam began.
>>Treatment Control Point Time	(3008,0025)	1	Time administration of treatment beam began.
>>Specified Meterset	(3008,0042)	2	Desired machine setting for current control point.
>>Delivered Meterset	(3008,0044)	1	Machine setting actually delivered at current control point.
>>Dose Rate Set	(300A,0115)	2	Dose Rate set on treatment machine for segment beginning at current control point (meterset/min).
>>Dose Rate Delivered	(3008,0048)	2	Dose Rate actually delivered for segment beginning at current control point (meterset/min).
>>Nominal Beam Energy	(300A,0114)	3	Nominal Beam Energy at control point.
>>Nominal Beam Energy Unit	(300A,0015)	1C	Units used for Nominal Beam Energy (300A,0114). Required if Nominal Beam Energy (300A,0114) is sent. Defined Terms: MV = Megavolt MEV = Mega electron-Volt If Radiation Type (300A,00C6) is PHOTON, Nominal Beam Energy Unit (300A,0115) shall be MV. If Radiation Type (300A,00C6) is ELECTRON, Nominal Beam Energy Unit (300A,0115) shall be MEV.
>>Wedge Position Sequence	(300A,0116)	3	Introduces sequence of Wedge positions for current control point. The sequence may contain one or more items.
>>>Referenced Wedge Number	(300C,00C0)	1C	Uniquely identifies wedge specified by Wedge Number (300A,00D2) within Beam referenced by Referenced Beam Number (300C,0006). Required if Wedge Position Sequence (300A,0116) is sent.
>>>Wedge Position	(300A,0118)	1C	Position of Wedge at current control point. Required if Wedge Position Sequence (300A,0116) is sent. Enumerated Values: IN, OUT.

>>Beam Limiting Device Position Sequence	(300A,011A)	1C	Introduces sequence of beam limiting device (collimator) jaw or leaf (element) positions. Required for Control Point 0 of Control Point Delivery Sequence (3008,0040) or if beam limiting device (collimator) changes during beam administration. The sequence may contain one or more items.
>>>RT Beam Limiting Device Type	(300A,00B8)	1C	<p>Type of beam limiting device. The value of this attribute shall correspond to RT Beam Limiting Device Type (300A,00B8) defined in an element of Beam Limiting Device Leaf Pairs Sequence (3008,00A0). Required if Beam Limiting Device Position Sequence (300A,011A) is sent.</p> <p>Enumerated Values:</p> <p>X = symmetric jaw pair in IEC X direction Y = symmetric jaw pair in IEC Y direction ASYMX = asymmetric jaw pair in IEC X direction ASYMY = asymmetric pair in IEC Y direction MLCX = multileaf (multi-element) jaw pair in IEC X direction MLCY = multileaf (multi-element) jaw pair in IEC Y direction</p>
>>>Leaf/Jaw Positions	(300A,011C)	1C	Positions of beam limiting device (collimator) leaf (element) or jaw pairs (mm) in IEC BEAM LIMITING DEVICE coordinate axis appropriate to RT Beam Limiting Device Type (300A,00B8), e.g. X-axis for MLCX, Y-axis for MLCY. Contains 2N values, where N is the Number of Leaf/Jaw Pairs (300A,00BC) defined in element of Beam Limiting Device Leaf Pairs Sequence (3008,00A0). Values shall be in IEC leaf subscript order 101, 201, 102, 202, ... 1N, 2N. Required if Beam Limiting Device Position Sequence (300A,011A) is sent.
>>Gantry Angle	(300A,011E)	1C	Treatment machine gantry angle, i.e. orientation of IEC GANTRY coordinate system with respect to IEC FIXED REFERENCE coordinate system (degrees). Required for Control Point 0 of Control Point Delivery Sequence (3008,0040) or if Gantry Angle changes during beam administration.

>>Gantry Rotation Direction	(300A,011F)	1C	<p>Direction of Gantry Rotation when viewing gantry from isocenter, for segment beginning at current Control Point. Required for Control Point 0 of Control Point Delivery Sequence (3008,0040), or if Gantry Rotation Direction changes during beam administration.</p> <p>Enumerated Values: CW = clockwise CC = counter-clockwise NONE = no rotation</p>
>>Beam Stopper Position	(3008,0230)	3	<p>Position of Beam Stopper during beam administration.</p> <p>Enumerated Values: EXTENDED = Beam Stopper extended RETRACTED = Beam Stopper retracted UNKNOWN = Position unknown</p>
>>Beam Limiting Device Angle	(300A,0120)	1C	<p>Beam Limiting Device (collimator) angle, i.e. orientation of IEC BEAM LIMITING DEVICE coordinate system with respect to IEC GANTRY coordinate system (degrees). Required for Control Point 0 of Control Point Delivery Sequence (3008,0040) or if beam limiting device (collimator) angle changes during beam delivery.</p>
>>Beam Limiting Device Rotation Direction	(300A,0121)	1C	<p>Direction of Beam Limiting Device Rotation when viewing beam limiting device (collimator) from radiation source, for segment beginning at current Control Point. Required for Control Point 0 of Control Point Delivery Sequence (3008,0040) or if Beam Limiting Device Rotation Direction changes during beam administration.</p> <p>Enumerated Values: CW = clockwise CC = counter-clockwise NONE = no rotation</p>
>>Patient Support Angle	(300A,0122)	1C	<p>Patient Support angle, i.e. orientation of IEC PATIENT SUPPORT (turntable) coordinate system with respect to IEC FIXED REFERENCE coordinate system (degrees). Required for Control Point 0 of Control Point Delivery Sequence (3008,0040) or if Patient Support Angle changes during beam administration.</p>

>>Patient Support Rotation Direction	(300A,0123)	1C	<p>Direction of Patient Support Rotation when viewing table from above, for segment beginning at current Control Point. Required for Control Point 0 of Control Point Delivery Sequence (3008,0040), or if Patient Support Rotation Direction changes during beam administration.</p> <p>Enumerated Values: CW = clockwise CC = counter-clockwise NONE = no rotation</p>
>>Table Top Eccentric Axis Distance	(300A,0124)	3	<p>Distance (positive) from the IEC PATIENT SUPPORT vertical axis to the IEC TABLE TOP ECCENTRIC vertical axis (mm).</p>
>>Table Top Eccentric Angle	(300A,0125)	1C	<p>Table Top (non-isocentric) angle, i.e. orientation of IEC TABLE TOP ECCENTRIC coordinate system with respect to IEC PATIENT SUPPORT coordinate system (degrees). Required for Control Point 0 of Control Point Delivery Sequence (3008,0040) or if Table Top Eccentric Angle changes during beam administration.</p>
>>Table Top Eccentric Rotation Direction	(300A,0126)	1C	<p>Direction of Table Top Eccentric Rotation when viewing table from above, for segment beginning at current Control Point. Required for Control Point 0 of Control Point Delivery Sequence (3008,0040) or if Table Top Eccentric Rotation Direction changes during beam administration.</p> <p>Enumerated Values: CW = clockwise CC = counter-clockwise NONE = no rotation</p>
>>Table Top Vertical Position	(300A,0128)	2C	<p>Table Top Vertical position in IEC TABLE TOP coordinate system (mm). This value is interpreted as an absolute, rather than relative, Table setting. Required for Control Point 0 of Control Point Delivery Sequence (3008,0040) or if Table Top Vertical Position changes during beam administration.</p>
>>Table Top Longitudinal Position	(300A,0129)	2C	<p>Table Top Longitudinal position in IEC TABLE TOP coordinate system (mm). This value is interpreted as an absolute, rather than relative, Table setting. Required for Control Point 0 of Control Point Delivery Sequence (3008,0040) or if Table Top Longitudinal Position changes during beam administration.</p>

>>Table Top Lateral Position	(300A,012A)	2C	Table Top Lateral position in IEC TABLE TOP coordinate system (mm). This value is interpreted as an absolute, rather than relative, Table setting. Required for Control Point 0 of Control Point Delivery Sequence (3008,0040) or if Table Top Lateral Position changes during beam administration.
>>Override Sequence	(3008,0060)	3	Introduces sequence of parameters which were overridden during the administration of the beam segment immediately prior to the current control point. The sequence may contain one or more items.
>>>Override Parameter Pointer	(3008,0062)	2C	Contains the Data Element Tag of the attribute which was overridden. Required if Override Sequence (3008,0060) is sent.
>>>Operator Name	(0008,1070)	2C	Name of operator who authorized override. Required if Override Sequence (3008,0060) is sent.
>>>Override Reason	(3008,0066)	3	User-defined description of reason for override of parameter specified by Override Parameter Pointer (3008,0062).

C.8.8.21.1 Control point machine delivery parameters

All treatment machine delivery parameters (including table angles and positions) in the RT Treatment Session Record Module shall be specified as absolute, not relative, values at the Control Point.

C.8.8.22 RT Brachy Session Record Module

Table C.8-54—RT BRACHY SESSION RECORD MODULE ATTRIBUTES

Attribute Name	Tag	Type	Attribute Description
Operator Name	(0008,1070)	2	Name of operator administering treatment session.
Referenced Fraction Group Number	(300C,0022)	3	Identifier of Fraction Group within referenced RT Plan.
Number of Fractions Planned	(300A,0078)	2	Total number of treatments (Fractions) planned for current Fraction Group.
Brachy Treatment Technique	(300A,0200)	1	Type of brachytherapy treatment technique. Enumerated Values: INTRALUMENARY, INTRACAVITARY, INTERSTITIAL, CONTACT, INTRAVASCULAR, PERMANENT. See RT Plan IOD.

Brachy Treatment Type	(300A,0202)	1	Type of brachytherapy treatment. Defined Terms: MANUAL = manually positioned HDR = High dose rate MDR = Medium dose rate LDR = Low dose rate PDR = Pulsed dose rate
Recorded Source Sequence	(3008,0100)	1	Introduces sequence of Sources to be used within Application Setups. The sequence may contain one or more items.
>Source Number	(300A,0212)	1	Identification number of the Source. The value of Source Number (300A,0212) shall be unique within the Recorded Source Sequence (3008,0100) in which it is created.
>Source Type	(300A,0214)	1	Type of Source. Defined Terms: POINT, LINE, CYLINDER, SPHERE.
>Source Manufacturer	(300A,0216)	2	Manufacturer of source.
>Source Serial Number	(3008,0105)	2	Serial Number of source.
>Source Isotope Name	(300A,0226)	1	User-defined name of Isotope.
>Source Isotope Half Life	(300A,0228)	1	Half-life of Isotope (days).
>Reference Air Kerma Rate	(300A,022A)	1	Air Kerma Rate in air of Isotope specified at Air Kerma Rate Reference Date (300A,022C) and Air Kerma Rate Reference Time (300A,022E) (in $\mu\text{Gy h}^{-1}$ at 1 m).
>Air Kerma Rate Reference Date	(300A,022C)	1	Reference date of Reference Air Kerma Rate (300A,022A) of Isotope.
>Air Kerma Rate Reference Time	(300A,022E)	1	Reference time of Air Kerma Rate (300A,022A) of Isotope.
Treatment Session Application Setup Sequence	(3008,0110)	1	Introduces sequence of Application Setups for RT Treatment Record for current RT Plan. The sequence may contain one or more items.
>Application Setup Type	(300A,0232)	1	Type of Application Setup. Defined Terms: FLETCHER_SUIT, DELCLOS, BLOEDORN, JOSLIN_FLYNN, CHANDIGARH, MANCHESTER, HENSCHKE, NASOPHARYNGEAL, OESOPHAGEAL, ENDOBRONCHIAL, SYED_NEBLETT, ENDORECTAL, PERINEAL.
>Referenced Brachy Application Setup Number	(300C,000C)	3	References application setup specified by Application Setup Number (300A,0234) in Application Setup Sequence (300A,0230) in RT Brachy Applications Module within referenced RT Plan.
>Application Setup Name	(300A,0236)	3	User-defined name for Application Setup.

>Application Setup Manufacturer	(300A,0238)	3	Manufacturer of Application Setup.
>Template Number	(300A,0240)	3	Identification number of the Template.
>Template Type	(300A,0242)	3	User-defined type for Template Device.
>Template Name	(300A,0244)	3	User-defined name for Template Device.
>Application Setup Check	(3008,0116)	3	Results of check-wire travel through all channels of current Application Setup. Enumerated Values: PASSED = Passed check FAILED = Failed check UNKNOWN = Unknown status
>Referenced Verification Image Sequence	(300C,0040)	3	Introduces sequence of verification images obtained during delivery of current beam. The sequence may contain one or more items. See Note.
>>Referenced SOP Class UID	(0008,1150)	1C	Uniquely identifies the referenced SOP Class. Required if Referenced Verification Image Sequence (300C,0040) is sent.
>>Referenced SOP Instance UID	(0008,1155)	1C	Uniquely identifies the referenced SOP Instance. Required if Referenced Verification Image Sequence (300C,0040) is sent.
>Total Reference Air Kerma	(300A,0250)	1	Total Reference Air Kerma for current Application Setup, i.e. the sum of the products of the Air Kerma Rates of each Source in each Channel with its respective Channel Time (μGy at 1 m).
>Referenced Measured Dose Reference Sequence	(3008,0080)	3	Introduces sequence of doses measured during treatment delivery, summed over entire session. The sequence may contain one or more items.
>>Referenced Dose Reference Number	(300C,0051)	1C	Uniquely references Dose Reference specified by Dose Reference Number (300A,0012) in Dose Reference Sequence (300A,0010) in RT Prescription Module of referenced RT Plan. Required if Referenced Measured Dose Reference Sequence (3008,0080) is sent and Referenced Measured Dose Reference Number (3008,0082) is not sent. It shall not be present otherwise.

>>Referenced Measured Dose Reference Number	(3008,0082)	1C	Uniquely references Measured Dose Reference specified by Measured Dose Reference Number (3008,0064) in Measured Dose Reference Sequence (3008,0010). Required if Referenced Measured Dose Reference Sequence (3008,0080) is sent and Referenced Dose Reference Number (300C,0051) is not sent. It shall not be present otherwise.
>>Measured Dose Value	(3008,0016)	1C	Measured Dose in units specified by Dose Units (3004,0002) in sequence referenced by Measured Dose Reference Sequence (3008,0010) or Dose Reference Sequence (300A,0010) in RT Prescription Module of referenced RT Plan as defined above. Required if Referenced Measured Dose Reference Sequence (3008,0080) is sent.
>Referenced Calculated Dose Reference Sequence	(3008,0090)	3	Introduces sequence of doses estimated for each treatment delivery. The sequence may contain one or more items.
>>Referenced Dose Reference Number	(300C,0051)	1C	Uniquely identifies Dose Reference specified by Dose Reference Number (300A,0012) in Dose Reference Sequence (300A,0010) in RT Prescription Module of referenced RT Plan. Required if Referenced Calculated Dose Reference Sequence (3008,0090) is sent and Referenced Calculated Dose Reference Number (3008,0092) is not sent. It shall not be present otherwise.
>>Referenced Calculated Dose Reference Number	(3008,0092)	1C	Uniquely identifies Calculated Dose Reference specified by Calculated Dose Reference Number (3008,0072) within Calculated Dose Reference Sequence (3008,0070). Required if Referenced Calculated Dose Reference Sequence (3008,0090) is sent and Referenced Dose Reference Number (300C,0051) is not sent. It shall not be present otherwise.
>>Calculated Dose Reference Dose Value	(3008,0076)	1C	Calculated Dose (Gy). Required if Referenced Calculated Dose Reference Sequence (3008,0090) is sent.
>Current Fraction Number	(3008,0022)	2	Fraction number for this application setup.
>Treatment Delivery Type	(300A,00CE)	2	Delivery Type of treatment. Defined Terms: TREATMENT = normal patient treatment CONTINUATION = continuation of interrupted treatment

>Treatment Termination Status	(3008,002A)	1	Conditions under which treatment was terminated. Enumerated Values: NORMAL = treatment terminated normally OPERATOR = operator terminated treatment MACHINE = machine terminated treatment for other than NORMAL condition UNKNOWN = status at termination unknown
>Treatment Termination Code	(3008,002B)	3	Treatment machine termination code. This code is dependent upon the particular application and equipment.
>Treatment Verification Status	(3008,002C)	2	Conditions under which treatment was verified by a verification system. Enumerated Values: VERIFIED = treatment verified VERIFIED_OVR = treatment verified with at least one out-of-range value overridden NOT_VERIFIED = treatment verified manually
>Recorded Brachy Accessory Device Sequence	(3008,0120)	3	Introduces sequence of Brachy Accessory Devices associated with current Application Setup. The sequence may contain one or more items.
>>Referenced Brachy Accessory Device Number	(3008,0122)	2C	Identification number of the Brachy Accessory Device. The value of Brachy Accessory Device Number (300A,0262) shall be unique within the Application Setup in which it is created. Required if Recorded Brachy Accessory Device Sequence (3008,0120) is sent.
>>Brachy Accessory Device ID	(300A,0263)	2C	User or machine supplied identifier for Brachy Accessory Device. Required if Recorded Brachy Accessory Device Sequence (3008,0120) is sent.
>>Brachy Accessory Device Type	(300A,0264)	1C	Type of Brachy Accessory Device. Required if Recorded Brachy Accessory Device Sequence (3008,0120) is sent. Defined Terms: SHIELD, DILATATION, MOLD, PLAQUE, FLAB.
>>Brachy Accessory Device Name	(300A,0266)	3	User-defined name for Brachy Accessory Device.
>Recorded Channel Sequence	(3008,0130)	1	Introduces sequence of Channels for current Application Setup. The sequence may contain one or more items.

>>Channel Number	(300A,0282)	1	Identification number of the Channel. The value of Channel Number (300A,0282) shall be unique within the Application Setup in which it is created.
>>Channel Length	(300A,0284)	2	Length of Channel (mm). See RT Plan IOD.
>>Specified Channel Total Time	(3008,0132)	1	Total amount of time specified between Control Point 0 and final Control Point of the Brachy Control Point Sequence (300A,02D0) for current Channel (sec).
>>Delivered Channel Total Time	(3008,0134)	1	Total amount of time actually delivered between Control Point 0 and final Control Point of the Brachy Control Point Sequence (300A,02D0) for current Channel (sec).
>>Source Movement Type	(300A,0288)	1	Type of Source movement. Defined Terms: STEPWISE, FIXED, OSCILLATING, UNIDIRECTIONAL.
>>Specified Number of Pulses	(3008,0136)	1C	Number of Pulses specified per fraction for current Channel. Required if Brachy Treatment Type (300A,0202) is PDR. See C.8.8.22.1.
>>Delivered Number of Pulses	(3008,0138)	1C	Number of Pulses actually delivered per fraction for current Channel. Required if Brachy Treatment Type (300A,0202) is PDR. See C.8.8.22.1.
>>Specified Pulse Repetition Interval	(3008,013A)	1C	Pulse repetition interval (sec) specified for current Channel. Required if Brachy Treatment Type (300A,0202) is PDR. See C.8.8.22.1.
>>Delivered Pulse Repetition Interval	(3008,013C)	1C	Pulse repetition interval (sec) actually delivered for current Channel. Required if Brachy Treatment Type (300A,0202) is PDR. See C.8.8.22.1.
>>Referenced Measured Dose Reference Sequence	(3008,0080)	3	Introduces sequence of doses measured during treatment delivery, summed over entire session. The sequence may contain one or more items.
>>>Referenced Dose Reference Number	(300C,0051)	1C	Uniquely references Dose Reference specified by Dose Reference Number (300A,0012) in Dose Reference Sequence (300A,0010) in RT Prescription Module of referenced RT Plan. Required if Referenced Measured Dose Reference Sequence (3008,0080) is sent and Referenced Measured Dose Reference Number (3008,0082) is not sent. It shall not be present otherwise.

>>>Referenced Measured Dose Reference Number	(3008,0082)	1C	References Measured Dose Reference specified by Measured Dose Reference Number (3008,0064) in Measured Dose Reference Sequence (3008,0010). Required if Referenced Measured Dose Reference Sequence (3008,0080) is sent and Referenced Dose Reference Number (300C, 0051) is not sent. It shall not be present otherwise.
>>>Measured Dose Value	(3008,0016)	1C	Measured Dose. Required if Referenced Measured Dose Reference Sequence (3008,0080) is sent.
>>Referenced Calculated Dose Reference Sequence	(3008,0090)	3	Introduces sequence of doses estimated for each treatment delivery. The sequence may contain one or more items.
>>>Referenced Dose Reference Number	(300C,0051)	1C	Uniquely identifies Dose Reference specified by Dose Reference Number (300A,0012) in Dose Reference Sequence (300A,0010) in RT Prescription Module of referenced RT Plan. Required if Referenced Calculated Dose Reference Sequence (3008,0090) is sent and Referenced Calculated Dose Reference Number (3008,0092) is not sent. It shall not be present otherwise.
>>>Referenced Calculated Dose Reference Number	(3008,0092)	1C	Uniquely identifies Calculated Dose Reference specified by Calculated Dose Reference Number (3008,0072) within Calculated Dose Reference Sequence (3008,0070). Required if Referenced Calculated Dose Reference Sequence (3008,0090) is sent and Referenced Dose Reference Number (300C,0051) is not sent. It shall not be present otherwise.
>>>Calculated Dose Reference Dose Value	(3008,0076)	1C	Calculated Dose (Gy). Required if Referenced Calculated Dose Reference Sequence (3008,0090) is sent.
>>Recorded Source Applicator Sequence	(3008,0140)	3	Introduces sequence of recorded Source Applicators. The sequence may contain one or more items.
>>>Referenced Source Applicator Number	(3008,0142)	2	Identification number of the Source Applicator. The value of Source Applicator Number (300A,0290) shall be unique within the Channel in which it is created.
>>>Source Applicator ID	(300A,0291)	2C	User or machine supplied identifier for Source Applicator. Required if Recorded Source Applicator Sequence (3008,0140) is sent.

>>>Source Applicator Type	(300A,0292)	1C	Type of Source Applicator. Required if Recorded Source Applicator Sequence (3008,0140) is sent. Enumerated Values: FLEXIBLE, RIGID.
>>>Source Applicator Name	(300A,0294)	3	User-defined name for Source Applicator.
>>>Source Applicator Length	(300A,0296)	1C	Length of Source Applicator (mm), defined as the distance between the connector of the applicator and the distal-most position of the source. Required if Recorded Source Applicator Sequence (3008,0140) is sent.
>>>Source Applicator Manufacturer	(300A,0298)	3	Manufacturer of Source Applicator.
>>>Source Applicator Step Size	(300A,02A0)	1C	Distance of path along channel (mm) between adjacent (potential) dwell positions. Required if Source Movement Type (300A,0288) is STEPPWISE.
>>Transfer Tube Number	(300A,02A2)	2	Identification number of the Transfer Tube. The value of Transfer Tube Number (300A,02A2) shall be unique within the Channel in which it is created.
>>Transfer Tube Length	(300A,02A4)	2C	Length of Transfer Tube of current afterloading Channel (mm). Required if value Transfer Tube Number (300A,02A2) is not zero length.
>>Recorded Channel Shield Sequence	(3008,0150)	3	Introduces sequence of Channel Shields associated with current Channel. The sequence may contain one or more items. See RT Plan IOD for description of Channel Shields.
>>>Referenced Channel Shield Number	(3008,0152)	2C	Identification number of the Channel Shield. The value of Channel Shield Number (300A,02B2) shall be unique within the Channel in which it is created. Required if Recorded Channel Shield Sequence (3008,0150) is sent.
>>>Channel Shield ID	(300A,02B3)	2C	User or machine supplied identifier for Channel Shield. Required if Recorded Channel Shield Sequence (3008,0150) is sent.
>>>Channel Shield Name	(300A,02B4)	3	User-defined name for Channel Shield.
>>Referenced Source Number	(300C,000E)	1	Uniquely identifies the referenced Source within the Recorded Source Sequence (3008,0100) for current Application Setup.
>>Safe Position Exit Date	(3008,0162)	1C	Date on which the source(s) exited the safe. Required if Recorded Channel Sequence (3008,0130) is sent and Brachy Treatment Type (300A,0202) is not MANUAL.

>>Safe Position Exit Time	(3008,0164)	1C	Time on which the source(s) exited the safe. Required if Recorded Channel Sequence (3008,0130) is sent and Brachy Treatment Type (300A,0202) is not MANUAL.
>>Safe Position Return Date	(3008,0166)	1C	Date on which the source(s) returned to the safe. Required if Recorded Channel Sequence (3008,0130) is sent and Brachy Treatment Type (300A,0202) is not MANUAL.
>>Safe Position Return Time	(3008,0168)	1C	Time on which the source(s) returned to the safe. Required if Recorded Channel Sequence (3008,0130) is sent and Brachy Treatment Type (300A,0202) is not MANUAL.
>>Number of Control Points	(300A,0110)	1	Number of control points in Channel. For an N-segment Channel there will be 2N (stepwise movement) or N+1 (continuous movement) control points.
>>Brachy Control Point Delivered Sequence	(3008,0160)	1	Introduces sequence of machine configurations describing this Channel. The sequence may contain two or more items. See RT Plan IOD and C.8.8.22.1 for description of Brachy Control Point Delivered Sequence.
>>>Referenced Control Point Index	(300C,00F0)	3	Index of current Control Point, starting at 0 for first Control Point.
>>>Treatment Control Point Date	(3008,0024)	1	Date when current Control Point occurred.
>>>Treatment Control Point Time	(3008,0025)	1	Time when current Control Point occurred.
>>>Control Point Relative Position	(300A,02D2)	1	Distance between current Control Point Position and the distal-most possible Source position in current Channel (mm). See RT Plan IOD.
>>>Override Sequence	(3008,0060)	3	Introduces sequence of parameters which were overridden during the administration of the treatment immediately prior to the current control point. The sequence may contain one or more items.
>>>>Override Parameter Pointer	(3008,0062)	2C	Contains the Data Element Tag of the attribute which was overridden. Required if Override Sequence (3008,0060) is sent.
>>>>Operator Name	(0008,1070)	2C	Name of operator who authorized override. Required if Override Sequence (3008,0060) is sent.
>>>>Override Reason	(3008,0066)	3	User-defined description of reason for override of parameter specified by Override Parameter Pointer (3008,0062).

Note: The Referenced Verification Image Sequence (300C,0040) may contain either images taken specifically for verification of the brachy application setup or reference images used in place of verification images, as might be done in HDR treatment planning.

C.8.8.22.1 PDR (Pulsed Dose Rate) Treatment

In Brachytherapy treatment techniques where Brachy Treatment Type (300A,0202) is PDR, the Brachy Control Point Sequence (300A,02D0) shall consist of 2N items, where N = Delivered Number of Pulses (3008,0138). Each control point pair shall specify the start and end of a single pulse.

C.8.8.23 RT Treatment Summary Record Module

Table C.8-55—RT TREATMENT SUMMARY RECORD MODULE ATTRIBUTES

Attribute Name	Tag	Type	Attribute Description
Current Treatment Status	(3008,0200)	1	Status of the Treatment at the time the Treatment Summary was created. Enumerated Values: NOT_STARTED, ON_TREATMENT, ON_BREAK, SUSPENDED, STOPPED, COMPLETED. See C.8.8.23.1.
Treatment Status Comment	(3008,0202)	3	Comment on current treatment status.
First Treatment Date	(3008,0054)	2	Date of delivery of the first treatment.
Most Recent Treatment Date	(3008,0056)	2	Date of delivery of the most recent administration.
Fraction Group Summary Sequence	(3008,0220)	3	Introduces sequence describing current state of planned vs. delivered fraction groups. The sequence may contain one or more items.
>Referenced Fraction Group Number	(300C,0022)	3	References Fraction Group Number (300A,0071) in Fraction Group Sequence (300A,0070) in the referenced RT Plan.
>Fraction Group Type	(3008,0224)	2C	Indicates type of fraction group. Required if Fraction Group Summary Sequence (3008,0220) is sent. Enumerated Values: EXTERNAL_BEAM, BRACHY.
>Number of Fractions Planned	(300A,0078)	2C	Number of fractions planned for this fraction group. Required if Fraction Group Summary Sequence (3008,0220) is sent.
>Number of Fractions Delivered	(3008,005A)	2C	Number of fractions delivered as of Treatment Summary Report. Required if Fraction Group Summary Sequence (3008,0220) is sent.
>Fraction Status Summary Sequence	(3008,0240)	3	Introduces sequence describing status of fractions in Fraction Group. The sequence may contain one or more items.
>>Referenced Fraction Number	(3008,0223)	1C	Identifies fraction. Required if Fraction Status Summary Sequence (3008,0240) is sent.

>>Treatment Date	(3008,0250)	2C	Date when fraction was delivered. Required if Fraction Status Summary Sequence (3008,0240) is sent.
>>Treatment Time	(3008,0251)	2C	Time when fraction was delivered. Required if Fraction Status Summary Sequence (3008,0240) is sent.
>>Treatment Termination Status	(3008,002A)	2C	Conditions under which treatment was terminated. Required if Fraction Status Summary Sequence (3008,0240) is sent. Enumerated Values: NORMAL = treatment terminated normally OPERATOR = operator terminated treatment MACHINE = machine terminated treatment for other than NORMAL condition UNKNOWN = status at termination unknown
Treatment Summary Measured Dose Reference Sequence	(3008,00E0)	3	Introduces sequence of references to Measured Dose References. The sequence may contain one or more items.
>Referenced Dose Reference Number	(300C,0051)	3	Uniquely identifies Dose Reference specified by Dose Reference Number (300A,0012) in Dose Reference Sequence (300A,0010) in RT Prescription Module of referenced RT Plan referenced in Referenced RT Plan Sequence (300C,0002) of RT General Treatment Record Module.
>Dose Reference Description	(300A,0016)	3	User-defined description of Dose Reference.
>Cumulative Dose to Dose Reference	(3008,0052)	1C	Cumulative Dose delivered to Dose Reference (Gy). Required if Treatment Summary Dose Reference Sequence (3008,00E0) is sent.
Treatment Summary Calculated Dose Reference Sequence	(3008,0050)	3	Introduces sequence of references to Calculated Dose References. The sequence may contain one or more items.
>Referenced Dose Reference Number	(300C,0051)	3	Uniquely identifies Dose Reference specified by Dose Reference Number (300A,0012) in Dose Reference Sequence (300A,0010) in RT Prescription Module of referenced RT Plan referenced in Referenced RT Plan Sequence (300C,0002) of RT General Treatment Record Module.
>Dose Reference Description	(300A,0016)	3	User-defined description of Dose Reference.
>Cumulative Dose to Dose Reference	(3008,0052)	1C	Cumulative Dose delivered to Dose Reference (Gy). Required if Treatment Summary Dose Reference Sequence (3008,0050) is sent.

Note: The RT Treatment Summary Record IOD may contain references to related RT Treatment Session Record IODs. These references are contained within the Referenced Treatment Record Sequence (3008,0030) of the RT General Treatment Record Module.

C.8.8.23.1 Current Treatment Status

The definition of the enumerated values for Current Treatment Status (3008,0200) are defined as follows:

NOT_STARTED	Patient has not yet begun treatment.
ON_TREATMENT	Patient is currently undergoing treatment.
ON_BREAK	Patient is currently not undergoing treatment, but a resumption date is known.
SUSPENDED	Patient is currently not undergoing treatment, but resumption of treatment is planned at an unknown date.
STOPPED	Patient has stopped treatment without completing the planned course.
COMPLETED	Patient completed the planned course of treatment.

A change in the Current Treatment Status (or any other field) in a RT Treatment Summary Record Object shall define a new instance of the RT Treatment Summary Record IOD.

C.8.9 PET Information Module Definitions

This Section describes Positron Emission Tomography series and image Modules. These Modules contain Attributes that are specific to Positron Emission Tomography images.

C.8.9.1 PET Series Module

Table C.8-56 contains IOD Attributes that describe a PET Series.

Table C.8-56 - PET SERIES MODULE ATTRIBUTES

Attribute Name	Tag	Type	Attribute Description
Series Date	(0008,0021)	1	Date the Series started. See C.8.9.1.1.2 for specialization.
Series Time	(0008,0031)	1	Time the Series started. See C.8.9.1.1.2 for specialization.
Units	(0054,1001)	1	Pixel value units. See C.8.9.1.1.3 for explanation. Defined terms: CNTS, NONE, CM2, PCNT, CPS, BQML, MGINML, UMOLMINML, MLMING, MLG, 1CM, UMOLML, PROPCNTS, PROPCPS, MLMINML, MLML, GML, STDDEV
Counts Source	(0054,1002)	1	The primary source of counts. The primary source leads to the underlying image Units (0054,1001), as opposed to secondary sources which are used during reconstruction correction. Enumerated Values: EMISSION TRANSMISSION
Series Type	(0054,1000)	1	A multi-valued indicator of the type of Series. See C.8.9.1.1.4 for explanation. Value 1 Enumerated Values: STATIC DYNAMIC GATED WHOLE BODY Value 2 Enumerated Values: IMAGE REPROJECTION
Reprojection Method	(0054,1004)	2C	Method for projecting volumetric data onto planar projection. Required if Series Type (0054,1000), Value 2 is REPROJECTION. Defined terms: SUM MAX PIXEL
Number of R-R Intervals	(0054,0061)	1C	The maximum number of R-R Intervals that may exist in this Series. Required if Series Type (0054,1000), Value 1 is GATED.

Number of Time Slots	(0054,0071)	1C	The maximum number of Time Slots that may exist in this Series. Required if Series Type (0054,1000), Value 1 is GATED.
Number of Time Slices	(0054,0101)	1C	The maximum number of Time Slices that may exist in this Series. Required if Series Type (0054,1000), Value 1 is DYNAMIC.
Number of Slices	(0054,0081)	1	The maximum number of Slices that may exist in this Series.
Corrected Image	(0028,0051)	2	A value that indicates which, if any, corrections have been applied to the images in this series. Defined terms: DECY=decay corrected ATTN=attenuation corrected SCAT=scatter corrected DTIM=dead time corrected MOTN=gantry motion corrected (e.g. wobble, clamshell) PMOT=patient motion corrected CLN=count loss normalization (correction for count loss in gated Time Slots). RAN=randoms corrected RADL=non-uniform radial sampling corrected DCAL=sensitivity calibrated using dose calibrator NORM=detector normalization
Randoms Correction Method	(0054,1100)	3	Type of randoms correction processing. Defined terms: NONE = no randoms correction DLYD = delayed event subtraction SING = singles estimation
Attenuation Correction Method	(0054,1101)	3	A textual description of the attenuation correction processing. e.g. measured vs. calculated, transmission source type (ring, line, point), assumed patient geometry (polygon, ellipse, segmented), attenuation coefficient, skull thickness), post-injection transmission, smoothing.
Scatter Correction Method	(0054,1105)	3	A textual description of the scatter correction processing. e.g. convolution-subtraction, dual energy window, model-based, use of attenuation data.

Decay Correction	(0054,1102)	1	The real-world event to which images in this Series were decay corrected. See C.8.9.1.1.5 for explanation. Defined terms: NONE = no decay correction START= acquisition start time ADMIN = radiopharmaceutical administration time
Reconstruction Diameter	(0018,1100)	3	Diameter, in mm, of the region within which the data was used in creating the reconstruction of the image. Data may exist outside this region and portions of the patient may exist outside this region.
Convolution Kernel	(0018,1210)	3	Textual description of the convolution kernel(s) used to reconstruct the data (e.g. name, cutoff, radial/axial/angular, mathematical form, DC handling)
Reconstruction Method	(0054,1103)	3	Textual description of reconstruction processing, e.g. 2D filtered backprojection, 2D iterative, 3D PROMIS, 3D FAVOR, 3D iterative.
Detector Lines of Response Used	(0054,1104)	3	Textual description of which detector lines of response were used, mashed, or otherwise processed during tomographic reconstruction.
Acquisition Start Condition	(0018,0073)	3	Description of how the data collection was started. Defined terms: DENS = density (counts/sec) RDD = relative density difference (change in counts/sec) MANU = manual TIME = time AUTO = automatic, when ready TRIG = physiological trigger See C.8.9.1.1.6 for explanation.
Acquisition Start Condition Data	(0018,0074)	3	Count density, change in count density, or physiological triggers causing data collection to start.
Acquisition Termination Condition	(0018,0071)	3	Description of how the data collection for the series was stopped. Defined terms: CNTS = counts DENS = density (counts/sec) RDD = relative density difference (change in counts/sec) MANU = manual OVFL = data overflow TIME = time TRIG = physiological trigger See C.8.4.9.1.3 for explanation.

Acquisition Termination Condition Data	(0018,0075)	3	Number of counts, count density, change in count density, or physiological triggers causing the termination.
Field of View Shape	(0018,1147)	3	Shape of the field of view of the PET camera. Defined Terms: CYLINDRICAL RING HEXAGONAL MULTIPLE PLANAR
Field of View Dimensions	(0018,1149)	3	Dimensions of the field of view, in mm. Transverse detector diameter followed by axial width.
Gantry/Detector Tilt	(0018,1120)	3	Angle of tilt in degrees of the gantry. See C.8.9.1.1.7 for explanation.
Gantry/Detector Slew	(0018,1121)	3	Angle of slew in degrees of the gantry. Positive slew is moving the gantry on the patient's left toward the patient's superior, when the patient is supine.
Type of Detector Motion	(0054,0202)	3	Describes the detector motion during acquisition. Defined Terms: NONE = stationary gantry STEP AND SHOOT = Interrupted motion, acquire only while stationary CONTINUOUS = Gantry motion and acquisition are simultaneous and continuous WOBBLE = wobble motion CLAMSHELL = clamshell motion
Collimator Type	(0018,1181)	2	Collimator Type. Defined Terms: NONE = no collimator RING = transverse septa
Collimator/Grid Name	(0018,1180)	3	Label describing the collimator used.
Axial Acceptance	(0054,1200)	3	Maximum axial angle accepted, in degrees.
Axial Mash	(0054,1201)	3	Number of adjacent axial lines of response mashed together. See C.8.9.1.1.8 for explanation.
Transverse Mash	(0054,1202)	3	Number of adjacent transverse lines of response mashed together. See C.8.9.1.1.9 for explanation.
Detector Element Size	(0054,1203)	3	Size of an individual detector element, in mm. Transverse dimension followed by axial dimension. For a discrete crystal, this is the crystal size. For a continuous detector, this is the pixel bin size.
Coincidence Window Width	(0054,1210)	3	The width of the coincidence timing window, in nsec. The maximum time difference accepted between two single events.

Energy Window Range Sequence	(0054,0013)	3	Sequence of Repeating Items that describes the energy windows used for this Series. This sequence may contain zero or more items. See C.8.9.1.1.10 for explanation.
>Energy Window Lower Limit	(0054,0014)	3	The lower limit of the energy window, in KeV.
>Energy Window Upper Limit	(0054,0015)	3	The upper limit of the energy window, in KeV.
Secondary Counts Type	(0054,1220)	3	Array defining the type of additional counts accumulated during acquisition. Defined terms: DLYD=delayed events SCAT=scattered events in secondary window SING=singles DTIM=events lost due to deadline

C.8.9.1.1 PET Series Attribute Descriptions

Note: The meaning of a General Series in DICOM is determined by the attributes in the General Series Module and by the Source Entities (Patient, Study, Frame of Reference, Equipment) that originate the Series. The Source Entities are the single-valued entities of the 1->n relationship, where the Series is the multi-valued entity. Therefore, a Series is a group of images that: are from the same patient and study; are from the same Equipment; and, are from the same spatial Frame of Reference.

The PET Image IOD further refines a PET Series IE by the attributes in the PET Series Module, the PET Isotope Module, and the PET Multi-gated Acquisition Module. These are the attributes that shall not change from Image to Image. Therefore, in addition to the criteria above for a General Series (same patient, study, frame of reference, equipment), the attributes in the PET Series IE define a PET series as a group of images that: are from the same temporal frame of reference; have the same fundamental meaning (e.g. same units: either activity density, metabolism, or attenuation); are derived from the same activity source (emission or transmission); are from the same isotope and radiopharmaceutical; were derived from the same reconstruction processing; and, originated from the same acquisition setup and parameters.

C.8.9.1.1.1 Specialization of Image Plane Module and Image Pixel Module Attributes

For PET Series, the following Image Pixel Module attributes shall not vary from Image to Image :

- Photometric Interpretation (0028,0004)
- Rows (0028,0010)
- Columns (0028,0011)
- Bits Allocated (0028,0100)
- Bits Stored (0028,0101)
- Pixel Representation (0028,0103)

For PET Series, the following Image Plane Module attributes shall not vary from Image to Image :

- Pixel Spacing (0028,0030)

For PET Series where Series Type (0054,1000), Value 2 is IMAGE, the following Image Plane Module attributes shall not vary from Image to Image :

Image Orientation (0020,0037)

Note: This means that for a Series Type (0054,1000) Value 2 of IMAGE, all images in the PET Series lie on parallel planes. The images, however, may have non-uniform spacing along the normals to the planes.

For PET Series where Series Type (0054,1000), Value 2 is REPROJECTION, the Image Orientation (0020,0037) attribute shall vary such that the images rotate about a single axis. Geometrically, the normal to each image plane is defined by the cross product of its row and column vectors. Each reprojection image has one Center Normal that passes through the center of the image. Reprojection images within a PET Series shall have their Center Normals be co-planar and pass through a single point.

C.8.9.1.1.2 Series Date, Series Time

For PET Series, Series Date (0008,0021) and Series Time (0008,0031) are specified to be Type 1. The Series Date (0008,0021) and Series Time (0008,0031) are used as the reference time for all PET Image attributes that are temporally related, including activity measurements. The Series Date (0008,0021) and Series Time (0008,0031) are not tied to any real-world event (e.g. acquisition start, radiopharmaceutical administration) and their real-world meaning are implementation dependent.

C.8.9.1.1.3 Units

The pixel value units of the Pixel Data (7FE0,0010). Defined Terms:

CNTS = counts
NONE = unitless
CM2 = centimeter**2
PCNT = percent
CPS = counts/second
BQML = Becquerels/milliliter
MGMINML = milligram/minute/milliliter
UMOLMINML = micromole/minute/milliliter
MLMING = milliliter/minute/gram
MLG = milliliter/gram
1CM = 1/centimeter
UMOLML = micromole/milliliter
PROPCNTS = proportional to counts
PROPCPS = proportional to counts/sec
MLMINML = milliliter/minute/milliliter
MLML = milliliter/milliliter
GML = grams/milliliter
STDDEV = standard deviations

C.8.9.1.1.4 Series Type

The Series Type (0054,1000), Value 1 is used to identify the spatial location and temporal nature of the images within a PET Series. The Enumerated Values and their definitions are:

STATIC = a group of images at varying spatial locations at the same time
DYNAMIC = a group of images at a set of spatial locations (e.g. slices) at varying time slices, with all spatial locations acquired at all time slices
GATED = a group of images at the same spatial location, same starting and ending time, but acquired in different time slots of (possibly) different R-R intervals

WHOLE BODY = same as STATIC, except covering multiple axial fields of view (and therefore acquired at a different time).

Notes: 1. Using this definition and the comments in C.8.9.1.1.1, here are some examples of PET series and the encoding of Series Type (0054,1000) Value 1.

Static acquisition: a group of n transverse images at varying superior<->inferior locations, all acquired between the same starting and ending time. Series Type = STATIC.

Dynamic acquisition: a group of n*m transverse images at n superior<->inferior locations, acquired with m different starting and ending times. Series Type = DYNAMIC.

Gated acquisition: a group of n*m*p transverse images at n superior<->inferior locations, all acquired between the same starting and ending time, acquired in m different R-R Intervals (as determined by Low R-R Value (0018,1081) and High R-R Value (0018,1082)), and acquired in p time slots of a given R-R Interval (as determined by Trigger Time (0054,1000)). Series Type = GATED.

Whole body acquisition: a group of n transverse images at varying superior<->inferior locations covering a significant fraction of the entire body. Series Type = WHOLE BODY.

Multiple axial fields of view: a group of n transverse images at varying superior<->inferior locations. Series Type = WHOLE BODY.

Interleaved: group of 2*n transverse images acquired at overlapped AFOVs to increase axial sampling. Series Type = WHOLE BODY.

Sagittal (Coronal, Oblique): sagittal (coronal, oblique) re-sliced images derived by reformatting transverse images. The Series Type is STATIC, DYNAMIC, GATED, or WHOLE BODY depending on source Series Type.

Arithmetic: images derived by an arithmetic operation on operand images. The Series Type is STATIC, DYNAMIC, GATED, or WHOLE BODY depending on source Series Type.

Metabolic: images derived by a metabolic model. The Series Type is STATIC, DYNAMIC, GATED, or WHOLE BODY depending on source Series Type.

2. Using this definition, here are some images that are not stored in the same PET Series:

Two images from the same scan that were reconstructed differently.

Emission and transmission images for the same Patient and Study, even if acquired simultaneously (because emission and transmission images have different reconstruction processing).

Two images of same patient, one after NH3 injection and one after FDG injection.

Two images: an original image created from reconstructed scan data and its derived image based on a metabolic model.

The Series Type (0054,1000), Value 2 is used to identify the volumetric meaning of the images within a PET Series. The Enumerated Values and their definitions are:

IMAGE = a tomographic image slice

REPROJECTION = a projection image derived from forward projection through slices of tomographic images, using the algorithm defined in Reprojection Method (0054,1004).

C.8.9.1.1.5 Decay Correction

The Decay Correction (0054,1102) is the real-world event to which images in this Series were decay corrected. If decay correction is applied, all images in the Series shall be decay corrected to the same time. The Defined Terms and definitions are:

NONE = no decay correction
START= acquisition start time, Acquisition Time (0008,0032)
ADMIN = radiopharmaceutical administration time, Radiopharmaceutical Start Time (0018,1072)

The time to which images have been decay corrected can be derived from Decay Factor (0054,1321), Frame Reference Time (0054,1300), Radionuclide Half Life (0018,1075), Series Date (0008,0021), and Series Time (0008,0031).

C.8.9.1.1.6 Acquisition Start Condition

Acquisition Start Condition (0018,0073) is the method of starting acquisition data collection. The Defined Terms and definitions are:

DENS = preset count density (counts/sec) was reached
RDD = preset relative count density difference (change in counts/sec) was reached
MANU = acquisition was started manually
TIME = preset time limit was reached
AUTO = start automatically, when ready
TRIG = preset number of physiological triggers was reached

C.8.9.1.1.7 Gantry/Detector Tilt

Gantry/Detector Tilt (0018,1120) for PET Image data is the angle in degrees of the gantry relative to the patient's major (Head to Feet) axis (or the table supporting the patient). Positive tilt is moving the top of the gantry towards the patient's feet.

C.8.9.1.1.8 Axial Mash

Axial Mash (0054,1201) is multi-valued and is defined as the number of unique axial Lines of Response (LOR) that were mashed together (center of the axial field of view only). Value 1 is the number of LORs mashed for an odd slice. Value 2 is the number of LORs mashed for an even slice. For discrete crystal scanners, each unique LOR corresponds to a pair of crystals. For continuous detectors whose bin size is variable, the number of LORs mashed is determined by the actual bin size divided by the Detector Element Size (0054,1203), Value 2. The value of Axial Mash (0054,1201) is the same regardless of whether the mashing was done during acquisition or reconstruction.

Note: As an example on a discrete crystal scanner, if a ring difference of -2,0,+2 are binned as an odd slice and a ring difference of -1,+1 are binned as an even slice, then the Axial Mash (0054,1201) is equal to $3\sqrt{2}$.

C.8.9.1.1.9 Transverse Mash

Transverse Mash (0054,1202) is defined as the number of unique transverse Lines of Response (LOR) that were mashed together. For discrete crystal scanners, each unique LOR corresponds to a pair of crystals. For continuous detectors whose bin size is variable, the number of LORs mashed is determined by the actual bin size divided by the Detector Element Size (0054,1203), Value 1. The value of Transverse Mash (0054,1202) is the same regardless of whether the mashing was done during acquisition or reconstruction.

C.8.9.1.1.10 Energy Window Range Sequence

Multiple energy windows are allowed in order to allow coincidence events based on additional Energy Windows (e.g. Compton events scattered in the detector). All energy windows are assumed to contribute to all images in the PET Series.

C.8.9.1.1.11 Temporal Relationships of Images in PET Series

The following diagram shows the temporal relationships of images within a PET Series.

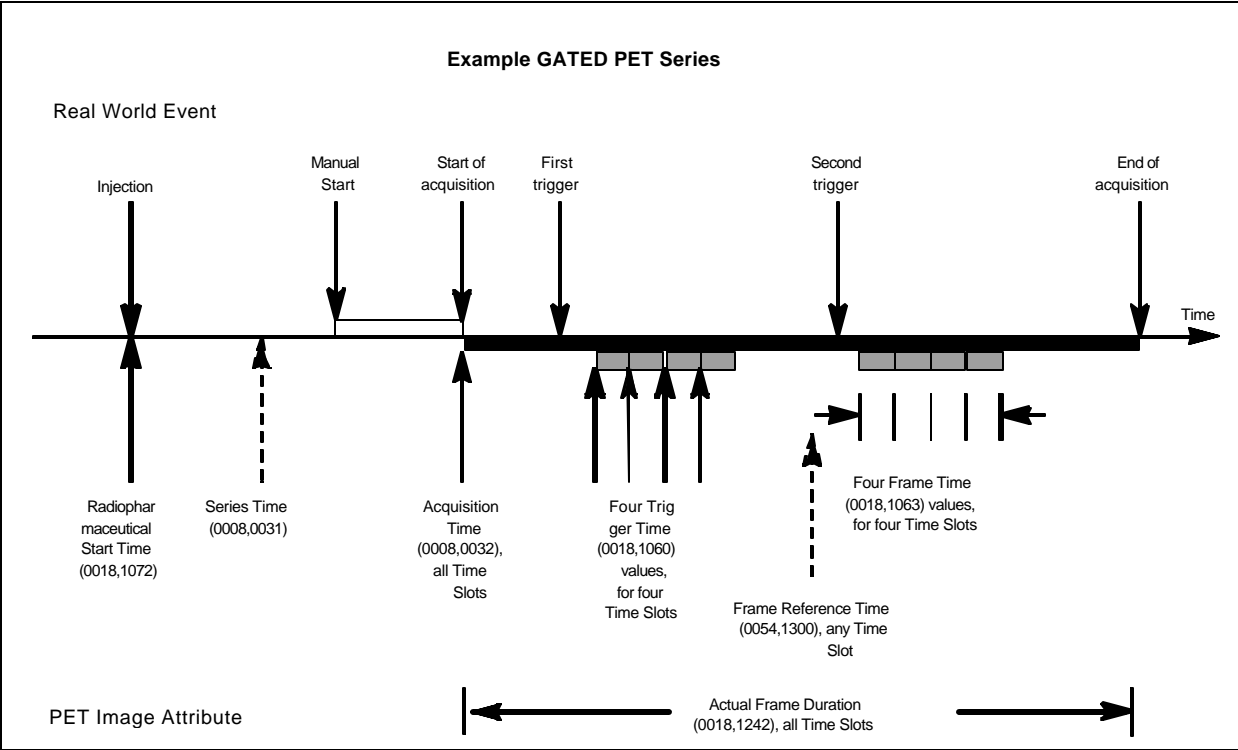
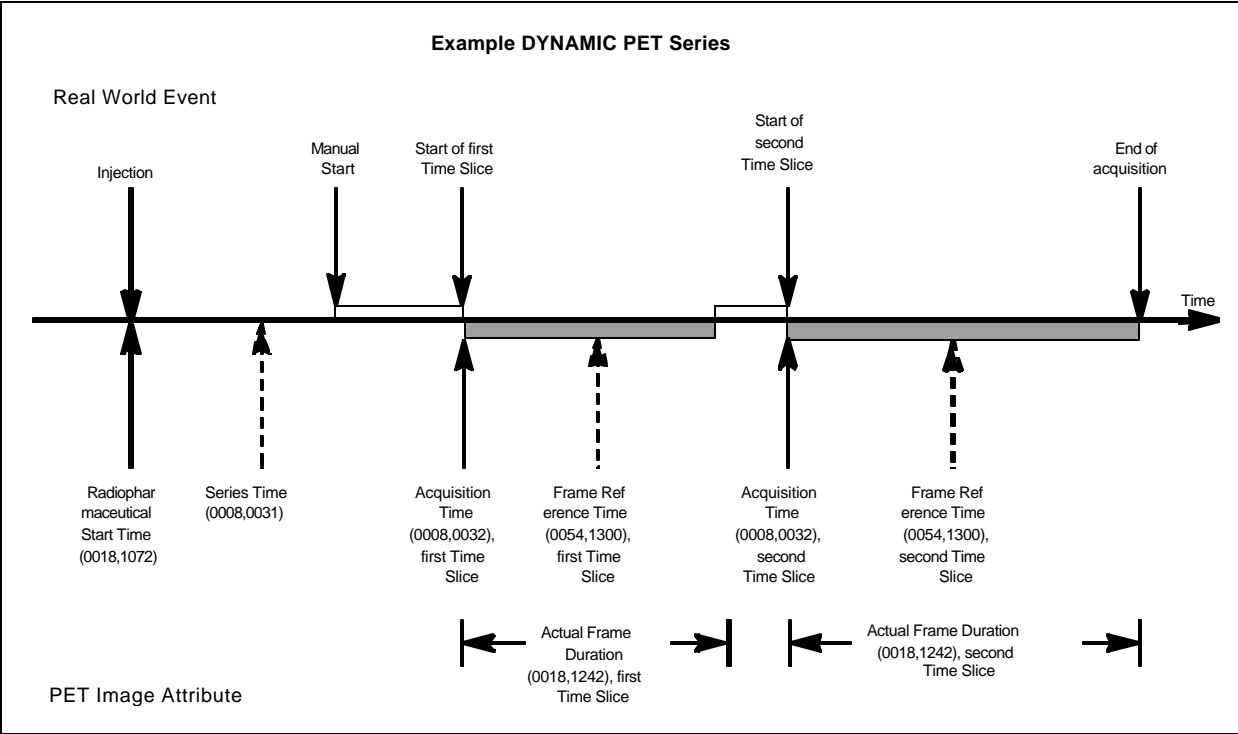

- Legend:
- Pause (no accumulation of counts)
 - Acquiring counts
 - Capable of acquiring counts
 - A time fixed to a real-world event
 - - - → A time not related to a real-world event

C.8.9.2 PET Isotope Module

Table C.8-57 contains IOD Attributes that describe a PET Isotope.

Table C.8-57 - PET ISOTOPE MODULE ATTRIBUTES

Attribute Name	Tag	Type	Attribute Description
Radiopharmaceutical Information Sequence	(0054,0016)	2	Sequence of Repeating Items that describe isotope information. This sequence may contain one or more items.
>Radionuclide Code Sequence	(0054,0300)	2	Sequence that identifies the radionuclide. This sequence shall contain exactly one item. See Section C.8.4.10.1.3 for explanation.
>>Include 'Code Sequence Macro' Table 8.8-1		Baseline Context ID is 4020 .	
>Radiopharmaceutical Route	(0018,1070)	3	Route of administration.
>Administration Route Code Sequence	(0054,0302)	3	Sequence that identifies the administration route of the radiopharmaceutical. This sequence shall contain exactly one item. See Section C.8.4.10.1.4 for explanation.
>>Include 'Code Sequence Macro' Table 8.8-1		Baseline Context ID is 11 .	
>Radiopharmaceutical Volume	(0018,1071)	3	Volume of administered radiopharmaceutical in cubic cm.
>Radiopharmaceutical Start Time	(0018,1072)	3	Time of start of administration. The actual time of radiopharmaceutical administration to the patient for imaging purposes, using the same time base as Series Time (0008,0031).
>Radiopharmaceutical Stop Time	(0018,1073)	3	Time of end of administration. The actual ending time of radiopharmaceutical administration to the patient for imaging purposes, using the same time base as Series Time (0008,0031).
>Radionuclide Total Dose	(0018,1074)	3	The radiopharmaceutical dose administered to the patient measured in Becquerels (Bq) at the Radiopharmaceutical Start Time (0018,1072).
>Radionuclide Half Life	(0018,1075)	3	The radionuclide half life, in seconds, that was used in the correction of this image.
>Radionuclide Positron Fraction	(0018,1076)	3	The radionuclide positron fraction (fraction of decays that are by positron emission) that was used in the correction of this image.
>Radiopharmaceutical Specific Activity	(0018,1077)	3	The activity per unit mass of the radiopharmaceutical, in Bq/micromole, at the Radiopharmaceutical Start Time (0018,1072).
>Radiopharmaceutical	(0018,0031)	3	Name of the radiopharmaceutical.

>Radiopharmaceutical Code Sequence	(0054,0304)	3	Sequence that identifies the radiopharmaceutical. This sequence shall contain exactly one item.
>>Include 'Code Sequence Macro' Table 8.8-1		Baseline Context ID is 4021 .	
Intervention Drug Information Sequence	(0018,0026)	3	Sequence of Repeating Items that describes the intervention drugs used. Zero or more items may be included in this sequence.
>Intervention Drug Name	(0018,0034)	3	Name of the intervention drug.
>Intervention Drug Code Sequence	(0018,0029)	3	Sequence that identifies the intervention drug name.
>>Include 'Code Sequence Macro' Table 8.8-1		Baseline Context ID is 10 .	
>Intervention Drug Start Time	(0018,0035)	3	Time of administration of the intervention drug, using the same time base as for the Series Time (0008,0031).
>Intervention Drug Stop Time	(0018,0027)	3	Time of completion of administration of the intervention drug, using the same time base as for the Series Time (0008,0031).
>Intervention Drug Dose	(0018,0028)	3	Intervention drug dose, in mg.

C.8.9.3 PET Multi-gated Acquisition Module

Table C.8-58 contains IOD Attributes that describe a PET Multi-gated Acquisition.

Table C.8-58 - PET MULTI-GATED ACQUISITION MODULE ATTRIBUTES

Attribute Name	Tag	Type	Attribute Description
Beat Rejection Flag	(0018,1080)	2	Heart beat duration sorting has been applied. Enumerated values: Y = yes N = no
Trigger Source or Type	(0018,1061)	3	Text indicating trigger source. Defined terms: EKG
PVC Rejection	(0018,1085)	3	Description of the type of PVC rejection criteria used.
Skip Beats	(0018,1086)	3	Number of beats skipped after a detected arrhythmia.
Heart Rate	(0018,1088)	3	Average number of heart beats per minute for the collection period for this image. This shall include all accepted beats as well as rejected beats.

Framing Type	(0018,1064)	3	Description of type of framing performed. Defined Terms: FORW = forward BACK = backward PCNT = forward/backward by percentage
--------------	-------------	---	--

C.8.9.4 PET Image Module

Table C.8-59 contains IOD Attributes that describe PET images.

Table C.8-59- PET IMAGE MODULE ATTRIBUTES

Attribute Name	Tag	Type	Attribute Description
Image Type	(0008,0008)	1	Image identification characteristics. See C.8.9.4.1.1 for specialization.
Samples per Pixel	(0028,0002)	1	Number of samples (planes) in this image. This value shall be 1.
Photometric Interpretation	(0028,0004)	1	Specifies the intended interpretation of the pixel data. See C.8.9.4.1.2 for specialization.
Bits Allocated	(0028,0100)	1	Number of bits allocated for each pixel sample. Each sample shall have the same number of bits allocated. Enumerated values: 16.
Bits Stored	(0028,0101)	1	Number of bits stored for each pixel sample. Each sample shall have the same number of bits stored. The value shall be the same as the value in Bits Allocated (0028,0100).
High Bit	(0028,0102)	1	Most significant bit for pixel sample data. Each sample shall have the same high bit. Shall be one less than the value in Bits Stored (0028,0101).
Rescale Intercept	(0028,1052)	1	The value b in relationship between stored values (SV) and pixel value units (U) defined in Units (0054,1001): $U = m \cdot SV + b$. The Rescale Intercept is always zero for PET images.
Rescale Slope	(0028,1053)	1	m in the equation specified in Rescale Intercept (0028,1052).
Frame Reference Time	(0054,1300)	1	The time that the pixel values in the image occurred. Frame Reference Time is the offset, in msec, from the Series reference time. See explanation in C.8.9.4.1.5.
Trigger Time	(0018,1060)	1C	Time interval, in msec, from the start of the trigger to the beginning of data acquisition for this image. Required if Series Type (0054,1000), Value 1 is GATED.
Frame Time	(0018,1063)	1C	Nominal duration per individual frame, in msec. Required if Series Type (0054,1000), Value 1 is GATED. See C.8.9.4.1.3 for explanation.
Low R-R Value	(0018,1081)	1C	R-R interval lower limit for beat rejection, in msec. Required if Series Type (0054,1000), Value 1 is GATED and Beat Rejection Flag (0018,1080) is Y.

High R-R Value	(0018,1082)	1C	R-R interval upper limit for beat rejection, in msec. Required if Series Type (0054,1000), Value 1 is GATED and Beat Rejection Flag (0018,1080) is Y.
Lossy Image Compression	(0028,2110)	1C	Specifies whether an Image has undergone lossy compression. Enumerated values: 00 = Image has NOT been subjected to lossy compression. 01 = Image has been subjected to lossy compression. See C.7.6.1.1.5. Required if Lossy Compression has been performed on the image.
Image Index	(0054,1330)	1	An index identifying the position of this image within a PET Series. See C.8.9.4.1.9 for explanation.
Acquisition Date	(0008,0022)	2	The date the acquisition of data that resulted in this image started. See C.8.9.4.1.4 for specialization.
Acquisition Time	(0008,0032)	2	The time the acquisition of data that resulted in this image started. See C.8.9.4.1.4 for specialization.
Actual Frame Duration	(0018,1242)	2	Elapsed time of the data acquisition for this image, in msec. See C.8.9.4.1.6 for explanation.
Nominal Interval	(0018,1062)	3	Average duration of accepted beats, in msec, of the R-R interval.
Intervals Acquired	(0018,1083)	3	Number of heartbeats that fall within Low R-R Value (0018,1081) and High R-R Value (0018,1082), and were therefore accepted and contribute coincidence events to this R-R Interval.
Intervals Rejected	(0018,1084)	3	Number of heartbeats that fall outside Low R-R Value (0018,1081) and High R-R Value (0018,1082), and do not contribute coincidence events to this R-R Interval. However, they may contribute coincidence events to other R-R Intervals.
Primary (Prompts) Counts Accumulated	(0054,1310)	3	The sum of events that occur in the primary event channel. The counts include Trues +Scatter+ Randoms if Randoms Correction Method (0054,1100) is NONE; otherwise the counts are Trues +Scatter.
Secondary Counts Accumulated	(0054,1311)	3	Sum of counts accumulated in secondary channels. See C.8.9.4.1.7 for explanation.

Slice Sensitivity Factor	(0054,1320)	3	The slice-to-slice sensitivity correction factor that was used to correct this image. The value shall be one if no slice sensitivity correction was applied.
Decay Factor	(0054,1321)	1C	The decay factor that was used to scale this image. Required if Decay Correction (0054,1102) is other than NONE. If decay correction is applied, all images in the Series shall be decay corrected to the same time.
Dose Calibration Factor	(0054,1322)	3	Factor that was used to scale this image from counts/sec to Bq/ml using a dose calibrator. The value shall be one if no dose calibration was applied. See C.8.9.4.1.8 for explanation.
Scatter Fraction Factor	(0054,1323)	3	An estimate of the fraction of acquired counts that were due to scatter and were corrected in this image. The value shall be zero if no scatter correction was applied.
Dead Time Factor	(0054,1324)	3	The average dead time correction factor that was applied to this image. The value shall be one if no dead time correction was applied.
Referenced Overlay Sequence	(0008,1130)	3	A sequence which provides reference to a set of SOP Class/Instance pairs which are related independent Overlays. Uniquely identifies Overlays significantly related to this Image. Zero or more Items may be included in this sequence.
>Referenced SOP Class UID	(0008,1150)	1C	Uniquely identifies the referenced SOP Class. Required if Referenced Overlay Sequence (0008,1130) is sent.
>Referenced SOP Instance UID	(0008,1155)	1C	Uniquely identifies the referenced SOP Instance. Required if Referenced Overlay Sequence (0008,1130) is sent.
Referenced Curve Sequence	(0008,1145)	3	A sequence which provides reference to a set of SOP Class/Instance pairs which are related independent Curves. Uniquely identifies Curves significantly related to this Image. Zero or more Items may be included in this sequence.
>Referenced SOP Class UID	(0008,1150)	1C	Uniquely identifies the referenced SOP Class. Required if Referenced Curve Sequence (0008,1145) is sent.
>Referenced SOP Instance UID	(0008,1155)	1C	Uniquely identifies the referenced SOP Instance. Required if Referenced Curve Sequence (0008,1145) is sent.

Anatomic Region Sequence	(0008,2218)	3	Sequence of one Item that identifies the anatomic region of interest in this image (i.e. external anatomy, surface anatomy, or general region of the body). See Section C.8.4.9.1.5.
>Include 'Code Sequence Macro' Table 8.8-1		Baseline Context ID is 1 .	
>Anatomic Region Modifier Sequence	(0008,2220)	3	Sequence of one or more Items that modify the anatomic region of interest in this image (i.e. prone, supine, decubitus right). See Section C.8.4.9.1.5.
>>Include 'Code Sequence Macro' Table 8.8-1		Baseline Context ID is 2 .	
Primary Anatomic Structure Sequence	(0008,2228)	3	Sequence of one or more Items that identifies the primary anatomic structure of interest in this image. See Section C.8.4.9.1.6.
>Include 'Code Sequence Macro' Table 8.8-1		Baseline Context ID is 1 .	
>Primary Anatomic Structure Modifier Sequence	(0008,2230)	3	Sequence of one or more Items that modify the primary anatomic structure of interest in this image. See Section C.8.4.9.1.6.
>>Include 'Code Sequence Macro' Table 8.8-1		Baseline Context ID is 2 .	

C.8.9.4.1 PET Image Module Attribute Descriptions

C.8.9.4.1.1 Image Type

For PET Images, Image Type (0008,0008) is specified to be Type 1.

Note: For PET images, Image Type (0008,0008) Value 1 will be ORIGINAL for reconstructed images. DERIVED may be appropriate for some other results images. For PET images, Image Type (0008,0008) Value 2 will be PRIMARY.

C.8.9.4.1.2 Photometric Interpretation

For PET images, Photometric Interpretation (0028,0004) shall have one of the following Enumerated Values:

MONOCHROME2

See C.7.6.3.1.2 for definition of this term.

C.8.9.4.1.3 Frame Time

The Frame Time (0018,1063) is the explicit duration of the gated frame when Framing Type (0018,1064) is equal to FORW or BACK. Frame Time (0018,1063) is the nominal duration of the gated frame when Framing Type (0018,1064) is equal to PCNT.

C.8.9.4.1.4 Acquisition Date, Acquisition Time

For PET Images, Acquisition Date (0008,0022) and Acquisition Time (0008,0032) are specified to be Type 2. The Acquisition Date (0008,0022) and Acquisition Time (0008,0032) use the same time base as Series Time (0008,0031).

For Series Type (0054,1000) Value 1 equal to STATIC, WHOLE BODY, or DYNAMIC, the Acquisition Time (0008,0032) is the real-world beginning of the accumulation of events into this

Image. For STATIC, WHOLE BODY, or DYNAMIC Series, the Acquisition Time (0008,0032) may vary from Image to Image within a PET Series.

For Series Type (0054,1000) Value 1 equal to GATED, the Acquisition Time (0008,0032) is the real-world beginning of the *capability* of accumulating events into this Image. (The *actual* accumulation of events has only occurred during an R-R Interval.) For GATED Series, the Acquisition Time (0008,0032) shall not vary from Image to Image within a PET Series.

C.8.9.4.1.5 Frame Reference Time

Frame Reference Time (0054,1300) is the time that the pixel values in the Image occurred. Frame Reference Time is defined as the time offset, in msec, from the Series Reference Time, where the Series Reference Time is defined by the combination of Series Date (0008,0021) and Series Time (0008,0031).

Note: Frame Reference Time (0054,1300) is implementation dependent and may or may not be tied to any real-world event. To illustrate the meaning of Frame Reference Time (0054,1300), the following are some examples of possible implementations:

Example 1: For a long-lived radionuclide and a non-time-varying radiopharmaceutical distribution, an implementation sets the Frame Reference Time (0054,1300) to the midpoint of the Actual Frame Duration (0018,1242).

Example 2: For a short-lived radionuclide and a non-time-varying radiopharmaceutical distribution, an implementation sets the Frame Reference Time (0054,1300) to the time at which the average activity occurs for a decaying radionuclide, T_{ave} . If image acquisition started at the Series Reference Time and the image has not been decay corrected, then T_{ave} will be:

$$T_{ave} = \frac{1}{\lambda} \ln \frac{\lambda T}{1 - e^{-\lambda T}}$$

where: λ = decay constant = $(\ln 2)/T_{1/2}$
 $T_{1/2}$ = Radionuclide Half Life (0018,1075)
 T = Actual Frame Duration (0018,1242)

Note that T_{ave} will be sooner than the midpoint of the Actual Frame Duration (0018,1242).

Example 3: For a short-lived radionuclide and a time-varying radiopharmaceutical distribution, an implementation with supplementary data (e.g. scanner count rates or blood sample data) sets the Frame Reference Time (0054,1300) to a derived time determined to be its best estimate of the time that the pixel values occurred.

C.8.9.4.1.6 Actual Frame Duration

The accumulation of counts for a PET Image shall occur entirely between:

- (1) the acquisition starting time (as specified by Acquisition Date (0008,0022) and Acquisition Time (0008,0032)), and
- (2) the acquisition ending time, which is equal to the acquisition starting time in (1) plus the Actual Frame Duration (0018,1242).

If the Series Type (0054,1000), Value 1 is GATED, then the actual accumulation of counts has only occurred during an R-R Interval.

C.8.9.4.1.7 Secondary Counts Accumulated

Secondary Counts Accumulated (0054,1311) is multi-valued and, if supplied, has Values corresponding to the Secondary Counts Type (0054,1220). The number and order of the Values in Secondary Counts Accumulated (0054,1311) shall be the same as Secondary Counts Type (0054,1220).

C.8.9.4.1.8 Dose Calibration Factor

The Dose Calibration Factor (0054,1322) is the factor that was used to scale this image from counts/sec to Bq/ml using an external dose calibrator. The value shall be one if no dose calibration was applied. The application of a dose calibration correction is specified by Corrected Image (0028,0051) equal to DCAL.

Note: Dose Calibration Factor (0054,1322) is not equal to the inverse of the sensitivity (kcps/Bq/ml) of the scanner, which is usually measured for a given radiopharmaceutical distribution and excluding the effects of attenuation.

C.8.9.4.1.9 Image Index

Image Index (0054,1330) is an index identifying the position of this image within a PET Series.

Note: The scheme for encoding Image Index (0054,1330) is as follows. Images within a PET Series can be viewed as a multi-dimensional array whose possible dimensions include R-R Intervals, Time Slots, Time Slices, and Slices. The dimensions of the array are defined by the Series Type (0054,1000) Value 1. Each dimension of the array has an index that identifies the position of this image in the array. The indices are: R-R Interval Index, Time Slot Index, Time Slice Index, Slice Index. The indices are calculated as follows:

Index	Range of Index	Order of Images along that Dimension
R-R Interval Index	1 to Number of R-R Intervals (0054,0061)	Increasing Low R-R Value (0018,1081)
Time Slot Index	1 to Number of Time Slots (0054,0071)	Increasing Trigger Time (0018,1060)
Time Slice Index	1 to Number of Time Slices (0054,0101)	Increasing Frame Reference Time (0054,1300)
Slice Index	1 to Number of Slices (0054,0081)	<p>If Series Type (0054,1000) Value 2 is IMAGE: Order is in increasing position along the normal, where the normal is determined by the cross product of the direction cosines of the row and column of the image. See Image Orientation (0020,0037) in the Image Plane Module.</p> <p>If Series Type (0054,1000) Value 2 is REPROJECTION: Order is in increasing or decreasing angle of the normal, where the normal is determined by the cross product of the direction cosines of the row and column of the image. See Image Orientation (0020,0037) in the Image Plane Module. (Note that reprojection images rotate about only a single axis as described in C.8.9.1.1.1. Therefore, all normals are co-planar and make a single angle with respect to each other.)</p>

Using these index values the position of this image within the multi-dimensional array (the Image Index (0054,1330)) is calculated as follows:

Series Type (0054,1000), Value 1	Dimensions of Array (Last dimension is most rapidly changing)	Encoding of Image Index (0054,1330)
STATIC	Slice	Slice Index
WHOLE BODY	Slice	Slice Index
DYNAMIC	Time Slice \ Slice	((Time Slice Index - 1) * (Number of Slices (0054,0081))) + Slice Index
GATED	R-R Interval \ Time Slot \ Slice	((R-R Interval Index - 1) * (Number of Time Slots (0054,0071)) * (Number of Slices (0054,0081))) + ((Time Slot Index - 1) * (Number of Slices (0054,0081))) + Slice Index

C.8.9.5 PET Curve Module

Table C.8-60 contains IOD Attributes that describe a PET Curve.

Table C.8-60 - PET CURVE MODULE ATTRIBUTES

Attribute Name	Tag	Type	Attribute Description
Curve Dimensions	(50xx,0005)	1	Number of dimensions for these data. The dimensions may be any number from 1 to n. See C.8.9.5.1.2 for specialization.
Type of Data	(50xx,0020)	1	Type of data in this curve. See C.8.9.5.1.3 for specialization of Defined Terms.
Curve Data	(50xx,3000)	1	Curve data. See C.10.2.1.4 and C.8.9.5.1.4 for further explanation.
Axis Units	(50xx,0030)	1	Units of measure for the axes. See C.8.9.5.1.5 for specialization of Defined Terms.
Dead Time Correction Flag	(0054,1401)	1C	Dead time correction has been applied to Curve Data (50xx,3000). Required if Type of Data (50xx,0020) is BLDSMPL. Enumerated Values: Y = yes N = no

Counts Included	(0054,1400)	2C	Type of counts included in this count rate data. Enumerated Values: TRUES SCATTER RANDOMS SINGLES Required if Axis Units (50xx,0030) contains CPS or CNTS.
Processing Function	(0018,5020)	3	A textual description of the processing that has been applied to this curve. (e.g. smoothing, time interpolation)

C.8.9.5.1 PET Curve Attribute Descriptions

C.8.9.5.1.1 Specialization of Curve Module Attributes

For PET Curves, all Curve Data (50xx,3000) values that are temporal are defined as time offsets from the Series Reference Time, where the Series Reference Time is defined by the combination of Series Date (0008,0021) and Series Time (0008,0031).

Note: Because the PET Curve is related to a single PET Series, all Curve Data (50xx,3000) points must be decay corrected (or not) to the same real-world event as defined in Decay Correction (0054,1102).

C.8.9.5.1.2 Curve Dimensions

If the Type of Data (50xx,0020) is SYSRATE, then the Curve Dimensions (50xx,0005) shall equal 2.

If the Type of Data (50xx,0020) is SLICERATE, then the Curve Dimensions (50xx,0005) shall equal 3.

If the Type of Data (50xx,0020) is BLDSMPL, then the Curve Dimensions (50xx,0005) shall equal 2.

If the Type of Data (50xx,0020) is CPM, then the Curve Dimensions (50xx,0005) shall equal 3.

C.8.9.5.1.3 Type of Data

A description of the Type of Data (50xx,0020) in this Curve. Defined Terms:

- SYSRATE = system count rate
- SLICERATE = slice count rate
- BLDSMPL = blood samples
- CPM = cardiac polar map

Note: Cardiac Polar Maps will be supported under the Standalone PET Curve IOD. This does not preclude the transmission of Cardiac Polar Maps in Secondary Capture images when preservation of quantitative information is not required.

C.8.9.5.1.4 Curve Data

If Type of Data (50xx,0020) is SYSRATE, then Curve Data (50xx,3000) is specified as $x_1y_1x_2y_2\dots$ where:

- x_n = time since Series Date (0008,0021) and Series Time (0008,0031)
- y_n = system count rate at time x_n .

If Type of Data (50xx,0020) is SLICERATE, then Curve Data (50xx,3000) is specified as $x_1 \setminus y_1 \setminus z_1 \setminus x_2 \setminus y_2 \setminus z_2 \setminus \dots$ where:

x_n = time since Series Date (0008,0021) and Series Time (0008,0031)
 y_n = position of slice
 z_n = slice count rate of slice y_n at time x_n

Values of y_n shall be increasing from patient inferior to superior.

If Type of Data (50xx,0020) is BLDSMPL, then Curve Data (50xx,3000) is specified as $x_1 \setminus y_1 \setminus x_2 \setminus y_2 \setminus \dots$ where:

x_n = time since Series Date (0008,0021) and Series Time (0008,0031)
 y_n = blood activity at time x_n .

If the Type of Data (50xx,0020) is BLDSMPL, then Axis Units (50xx,0030) Value 1 shall be MILS or SEC, and Axis Units (50xx,0030) Value 2 shall be BQML or CPS.

If Type of Data (50xx,0020) is CPM, then Curve Data (50xx,3000) is specified as $x_1 \setminus y_1 \setminus z_1 \setminus x_2 \setminus y_2 \setminus z_2 \setminus \dots$ where:

x_n = distance from apex along long axis of heart
 y_n = start angle of sector
 z_n = value for sector in appropriate units.

Sector boundaries (y_n) are measured in degrees clockwise relative to the antero-lateral wall. The end angle for a sector is the start angle of next largest y_n value for the same x_n . The end angle for the last sector is the start angle of the smallest y_n for the same x_n .

C.8.9.5.1.5 Axis Units

Axis Units (50xx,0030) are the units of measure for the axes. One value for each dimension. The order for the units is the same as the dimensions for the curve data in Curve Data (50xx,3000).

Defined Terms:

SEC = seconds
CNTS = counts
MM = millimeters
NONE = unitless
CM = centimeters
CM2 = cm^2
DEG = degrees
MILS = milliseconds
PCNT = percent
CPS = counts/second
BQML = Becquerels/milliliter
MGMINML = milligram/minute/milliliter
UMOLMINML = micromole/minute/milliliter
MLMING = milliliter/minute/gram
MLG = milliliter/gram
1CM = 1/centimeter
UMOLML = micromole/milliliter
PROPCNTS = proportional to counts
PROPCPS = proportional to counts/sec
MLMINML = milliliter/minute/milliliter

MLML = milliliter/milliliter

GML = grams/milliliter

STDDEV = standard deviations

If the Type of Data (50xx,0020) is SYSRATE, then Axis Units (50xx,0030) Value 1 shall be MILS or SEC, and Axis Units (50xx,0030) Value 2 shall be CPS.

If the Type of Data (50xx,0020) is SLICERATE, then Axis Units (50xx,0030) Value 1 shall be MILS or SEC, Axis Units (50xx,0030) Value 2 shall be MM or CM, and Axis Units (50xx,0030) Value 3 shall be CPS. Values of Axis Units (50xx,0030) Value 2 shall be increasing from patient inferior to superior.

If the Type of Data (50xx,0020) is BLDSMPL, then Axis Units (50xx,0030) Value 1 shall be MILS or SEC, and Axis Units (50xx,0030) Value 2 shall be BQML or CPS.

If the Type of Data (50xx,0020) is CPM, then Axis Units (50xx,0030) Value 1 shall be MM or CM, Axis Units (50xx,0030) Value 2 shall be DEG, and Axis Units (50xx,0030) Value 3 shall be one of:

CNTS, NONE, CM2, PCNT, CPS, BQML, MGINMML, UMOLMINML, MLMING, MLG, 1CM, UMOLML, PROPCNTS, PROPCPS, MLMINML, MLML, GML, STDDEV

C.8.10 Hardcopy Modules

C.8.10.1 Hardcopy Equipment Module

This Module describes equipment used to create Hardcopy Grayscale and Color Image IODs.

Table C.8-61
HARDCOPY EQUIPMENT MODULE ATTRIBUTES

Attribute Name	Tag	Type	Attribute Description
Modality	(0008,0060)	1	Type of equipment that created this Hardcopy Image. Enumerated Value: HC
Hardcopy Creation Device ID	(0018,1011)	3	User defined identification of the device that created this Hardcopy Image.
Hardcopy Device Manufacturer	(0018,1017)	3	Manufacturer of the device that created this Hardcopy Image.
Hardcopy Device Software Versions	(0018,101A)	3	Manufacturer's designation of the software of the device that created this Hardcopy Image.
Hardcopy Device Manufacturer's Model Name	(0018,101B)	3	Manufacturer's model number of the device that created this Hardcopy Image.

Note: The Attributes specified in the General Equipment Module (See Table C.7-6) describe the equipment which created the image that was the source for this Hardcopy Image. The Attributes of the Hardcopy Equipment Module define the equipment that created the Hardcopy Image.

C.8.10.2 Hardcopy Grayscale Image Module

This Module describes a printable 8 or 12 bit grayscale image. The Hardcopy Grayscale Image Pixel Module is a specialization of the Image Pixel Module defined in C.7.6.3 of this part.

Table C.8-62
HARDCOPY GRAYSCALE IMAGE MODULE ATTRIBUTES

Attribute Name	Tag	Type	Attribute Description
Samples Per Pixel	(0028,0002)	1	See C.7.6.3 for description of Image Pixel Module; Enumerated Value: 1
Photometric Interpretation	(0028,0004)	1	See C.7.6.3 for description of Image Pixel Module; Enumerated Values: MONOCHROME1 MONOCHROME2
Rows	(0028,0010)	1	See C.7.6.3 for description of Image Pixel Module.
Columns	(0028,0011)	1	See C.7.6.3 for description of Image Pixel Module.
Pixel Aspect Ratio	(0028,0034)	1C	See C.7.6.3 for description of Image Pixel Module. Required if the aspect ratio is not 1\1.
Bits Allocated	(0028,0100)	1	See C.7.6.3 for description of Image Pixel Module. Enumerated Values: 8 (if Bits Stored = 8) 16 (if Bits Stored =12)

Bits Stored	(0028,0101)	1	See C.7.6.3 for description of Image Pixel Module. Enumerated Values: 8, 12
High Bit	(0028,0102)	1	See C.7.6.3 for description of Image Pixel Module. The value shall be Bits Stored (0028,0101) - 1.
Pixel Representation	(0028,0103)	1	See C.7.6.3 for description of Image Pixel Module. Enumerated Value: 0000H (unsigned integer)
Pixel Data	(7FE0,0010)	1	See C.7.6.3 for description of Image Pixel Module.

C.8.10.3 Hardcopy Color Image Module

This Module describes a printable 8 bit RGB Color image. The Hardcopy Color Image Pixel Module is a specialization of the Image Pixel Module defined in C.7.6.3 of this part.

**Table C.8-63
HARDCOPY COLOR IMAGE MODULE ATTRIBUTES**

Attribute Name	Tag	Type	Attribute Description
Samples Per Pixel	(0028,0002)	1	See C.7.6.3 for description of Image Pixel Module; Enumerated Value: 3
Photometric Interpretation	(0028,0004)	1	See C.7.6.3 for description of Image Pixel Module; Enumerated Value: RGB
Planar Configuration	(0028,0006)	1	See C.7.6.3 for description of Image Pixel Module; Enumerated Value: 0001H (frame interleave)
Rows	(0028,0010)	1	See C.7.6.3 for description of Image Pixel Module.
Columns	(0028,0011)	1	See C.7.6.3 for description of Image Pixel Module.
Pixel Aspect Ratio	(0028,0034)	1C	See C.7.6.3 for description of Image Pixel Module. Required if the aspect ratio is not 1\1.
Bits Allocated	(0028,0100)	1	See C.7.6.3 for description of Image Pixel Module; Enumerated Value: 8
Bits Stored	(0028,0101)	1	See C.7.6.3 for description of Image Pixel Module; Enumerated Value: 8
High Bit	(0028,0102)	1	See C.7.6.3 for description of Image Pixel Module; Enumerated Value: 7
Pixel Representation	(0028,0103)	1	See C.7.6.3 for description of Image Pixel Module; Enumerated Value: 0000H (unsigned integer)

Pixel Data	(7FE0,0010)	1	See C.7.6.3 for description of Image Pixel Module
------------	-------------	---	---

C.8.11 DX Modules

C.8.11.1 DX Series Module

The Digital X-Ray IODs use the General Series module described in section C.7.3.1, specialized by the DX Series Module, to describe the DICOM Series Entity described in A.1.2.3, and to define what constitutes a Series for the context of projection Digital X-Ray.

Note: In an abstract sense, a series may be viewed from the perspective of an acquisition device or a display device.

In the former case, it is convenient to group images related by commonality of acquisition parameters, such as the imaging subject's physical relationship to the equipment (such as a patient lying in a particular position with respect to the equipment), a single acquisition initiation (such as an MR pulse sequence or spiral CT run), or a single workflow action on the part of the operator (such as the reading of a collection of CR plates from the same examination).

In the latter case, it is often convenient to organize images for viewing or browsing into series based upon other criteria such as physical or temporal proximity that may not necessarily correspond with the order or grouping in which the images were acquired.

This conflict is most apparent in the existing CR Image IOD C.8.1, where the definition of View Position at the Series Level in CR Series C.8.1.1 implies, for example, that a Lateral and PA Chest X-Ray may not be grouped into a single series. While this may be in keeping with the traditional CT and MR notions that a change in an imaging subject's physical orientation with respect to the imaging equipment implies a new series, it is most unnatural from the point of view of a reader viewing or browsing a collection of projection radiographic images.

A similar example pertains in the case of the traditional set of views of the maxillary and mandibular dentition, in which all the images are logically grouped in one sequence, but the imaging equipment moves with respect to the imaging subject, and the size of the detector may vary between images.

Accordingly, the constraint (apparent from the CT, MR and CR IODs) that a change in position, detector, body part or laterality implies a new series has been relaxed in the DX IODs, through the use of the DX Anatomy Imaged Module and the DX Positioning Module which define Attributes at the Image level that specify these concepts with finer granularity. This approach is consistent with that used in the XA, XRF, US and NM IODs.

Images within a series are still required, if the Condition for the inclusion of the Frame of Reference Module is met, to be relative to the same Frame of Reference.

Table C.8-64 specifies the Attributes which identify and describe general information about the DX Series.

**Table C.8-64
DX SERIES MODULE ATTRIBUTES**

Attribute Name	Tag	Type	Attribute Description
Modality	(0008,0060)	1	Type of equipment that originally acquired the data used to create the images in this Series. Enumerated Values: DX PX IO MG See section C.7.3.1.1.1 for further explanation.
Referenced Study Component Sequence	(0008,1111)	1C	Uniquely identifies the Study Component SOP Instance or Modality Performed Procedure Step SOP Instance to which the Series is related. The Sequence shall have one Item. Required if Study Component SOP Class or Modality Performed Procedure Step SOP Class is supported.
>Referenced SOP Class UID	(0008,1150)	1C	Uniquely identifies the referenced SOP Class. Required if Referenced Study Component Sequence(0008,1111) is sent.
>Referenced SOP Instance UID	(0008,1155)	1C	Uniquely identifies the referenced SOP Instance. Required if Referenced Study Component Sequence(0008,1111) is sent.
Presentation Intent Type	(0008,0068)	1	Identifies the intent of the images that are contained within this Series. Enumerated Values: FOR PRESENTATION FOR PROCESSING See C.8.11.1.1.1 for further explanation.

C.8.11.1.1 DX Series Attribute Descriptions

C.8.11.1.1.1 Presentation Intent Type

Presentation Intent Type (0008,0068) shall identify the intent for the purposes of display or other presentation of all Images within this Series.

- Notes:
1. Since this is a Series level attribute, all Images within a Series have the same value for this Attribute.
 2. The intent of this restriction is to ensure that FOR PRESENTATION and FOR PROCESSING images are placed in separate Series, so that no confusion can arise as to which images are suitable for diagnostic reading as determined by local policy.

A Series of Images intended for viewing by an observer, after application of any grayscale transformations specified in the image object such as VOI LUT, shall have an Enumerated Value of FOR PRESENTATION.

- Notes:
1. These images may still be of Image Type (0008,0008) ORIGINAL rather than DERIVED despite the possibility that they may have undergone some processing, such as unsharp masking. In this case a DERIVED image would have undergone yet further processing to make it substantially different from the original. See Figure C.8-5.
 2. These images may still be subjected to processing or further processing, if appropriate, depending on the application.
 3. These images are intended for display on a device, without (further) processing, since that device may not be capable of image processing. The quality of the displayed image or its suitability for any purpose is beyond the scope of the DICOM Standard.

Images that have been corrected to account for characteristics of the detector but which are intended to be further processed before being displayed, shall have an Enumerated Value of FOR PROCESSING.

- Note:
- This type is provided to allow the functions of image acquisition and image processing for presentation to be separated and yet have images conveyed between the two processes using a DICOM object. Individual sites or users may choose to substitute their own specialized processing in place of that supplied by the implementor.
- Images available at this stage of processing may be useful for quality control and problem solving purposes, as well as academic research.
- Images of this type may also be archived, retrieved and processed with different algorithms or parameters in order to alter the appearance of specific features for clinical purposes.
- The nature of the detector correction that may have been applied before sending an image of type FOR PROCESSING is not specified. In particular, acquisitions that acquire several sets of matrices of pixel values (such as image data, gain offset and a defect map) must perform some processing (detector correction) before a DX Image object can be instantiated.
- The nature of the processing that may have been applied before sending an image of type FOR PRESENTATION is also not specified.
- It is expected that individual implementors will use Private Attributes to convey specifics of the processing applied that may be of use for further processing by those aware of the parameters and algorithms. The diversity of detector types and processing algorithms make it undesirable to standardize such parameters.

If images from the same exposure exist with different Values of Presentation Intent Type (0008,0068), then they shall have different SOP Instance UIDs.

- Notes:
1. Source Image Sequence (0008,2112) may be used to relate these images.
 2. The SOP Class UIDs of the two images will also be different.

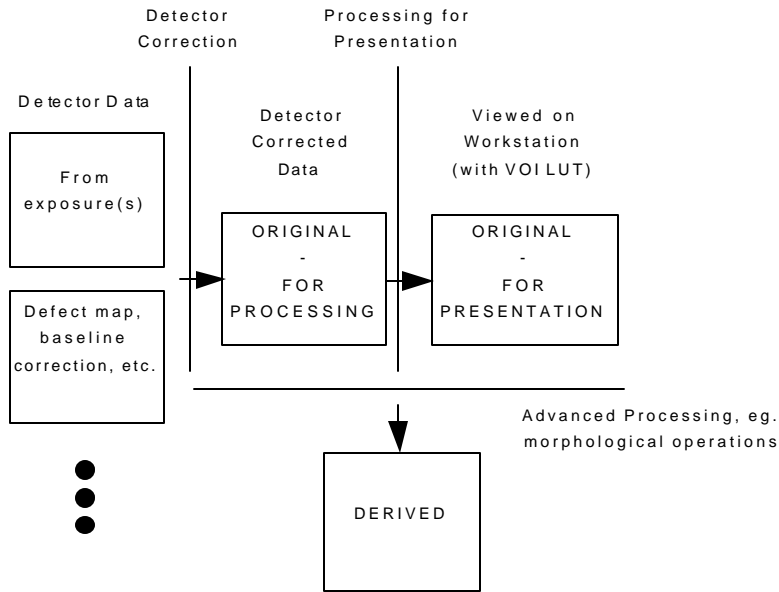

Figure C.8-5 - Explanation of Presentation Intent Type

C.8.11.2 DX Anatomy Imaged Module

Table C.8-65 contains IOD Attributes that describe the anatomy contained in a DX IOD.

**Table C.8-65
DX ANATOMY IMAGED MODULE ATTRIBUTES**

Attribute Name	Tag	Type	Attribute Description
Image Laterality	(0020,0062)	1	<p>Laterality of (possibly paired) body part (as described in Anatomic Region Sequence (0008,2218)) examined.</p> <p>Enumerated Values: R = right L = left U = unpaired B = both left and right</p> <p>Note: This Attribute is mandatory, in order to ensure that images may be positioned correctly relative to one another for display.</p> <p>Shall be consistent with any laterality information contained in Primary Anatomic Structure Modifier Sequence (0008,2230), if present.</p> <p>Note: Laterality (0020,0060) is a Series level Attribute and must be the same for all Images in the Series, hence it must be absent.</p>

Anatomic Region Sequence	(0008,2218)	2	Sequence that identifies the anatomic region of interest in this image (i.e. external anatomy, surface anatomy, or general region of the body). This anatomic region is placed on the table or bucky for examination. Note: It is strongly recommended that this Attribute be sent with a value, in order to ensure that images may be positioned correctly relative to one another for display. See C.8.11.2.1.1 for further explanation. Only a single Item shall be permitted in this Sequence.
>Include 'Code Sequence Macro' Table 8.8-1.			Baseline Context ID is 4009
>Anatomic Region Modifier Sequence	(0008,2220)	3	Sequence that modifies the anatomic region of interest in this image (i.e. prone, supine, decubitus right). May be present only if Anatomic Region Sequence (0008,2218) is sent. See C.8.11.2.1.1 for further explanation. One or more Items may be included in this Sequence.
>>Include 'Code Sequence Macro' Table 8.8-1.			Baseline Context ID is 2
Primary Anatomic Structure Sequence	(0008,2228)	3	Sequence that identifies the primary anatomic structures of interest in this image. See C.8.11.2.1.2 for further explanation. One or more Items may be included in this Sequence.
>Include 'Code Sequence Macro' Table 8.8-1.			Baseline Context ID is 1
>Primary Anatomic Structure Modifier Sequence	(0008,2230)	3	Sequence that modifies the primary anatomic structure of interest in this image. May be present only if Primary Anatomic Structure Sequence (0008,2228) is sent. See C.8.11.2.1.2 for further explanation. One or more Items may be included in this Sequence.
>>Include 'Code Sequence Macro' Table 8.8-1.			Baseline Context ID is 2

C.8.11.2.1 DX Anatomy Imaged Attribute Descriptions

The Attributes in this Module extend the function of Body Part Examined (0018,0015) as used in other IODs, and are intended to be used to facilitate the management of images and series in terms of routing, storage and display, as well as to dictate certain Conditions on Attributes and Modules in the DX IOD.

C.8.11.2.1.1 Anatomic Region

The general region of the body (e.g. the anatomic region, organ, or body cavity being examined) may be identified by the Anatomic Region Sequence (0008,2218). Characteristics of the anatomic region being examined may be refined by the Anatomic Region Modifier Sequence (0008,2220).

Note: Coding mechanisms may be defined for specific clinical contexts.

C.8.11.2.1.2 Primary Anatomic Structure

The specific anatomic structures of interest within the image are identified by the Primary Anatomic Structure Sequence (0008,2228). Characteristics of the anatomic structure may be refined by the Primary Anatomic Structure Modifier Sequence (0008,2230).

C.8.11.3 DX Image Module

Table C.8-66 contains IOD Attributes that describe a DX Image by specializing Attributes of the General Image and Image Pixel Modules, and adding additional Attributes.

**Table C.8-66
DX IMAGE MODULE ATTRIBUTES**

Attribute Name	Tag	Type	Attribute Description
Image Type	(0008,0008)	1	Image identification characteristics. See C.8.11.3.1.1 for specialization.
Samples per Pixel	(0028,0002)	1	Number of samples in this image. Shall have an Enumerated Value of 1.
Photometric Interpretation	(0028,0004)	1	Specifies the intended interpretation of the pixel data. Enumerated Values: MONOCHROME1 MONOCHROME2
Bits Allocated	(0028,0100)	1	Number of bits allocated for each pixel sample. Enumerated Values: 8, 16
Bits Stored	(0028,0101)	1	Number of bits stored for each pixel sample. Enumerated Values: 6 to 16
High Bit	(0028,0102)	1	Most significant bit for pixel sample data. Shall have an Enumerated Value of one less than the value in Bit Stored (0028,0101).
Pixel Representation	(0028,0103)	1	Data representation of the pixel samples. Shall have the Enumerated Value: 0000H = Unsigned Integer.

Pixel Intensity Relationship	(0028,1040)	1	The relationship between the Pixel sample values and the X-Ray beam intensity. Enumerated Values: LIN = Linearly proportional to X-Ray beam intensity LOG = Logarithmically proportional to X-Ray beam intensity See C.8.11.3.1.2 for further explanation.
Pixel Intensity Relationship Sign	(0028,1041)	1	The sign of the relationship between the Pixel sample values stored in Pixel Data (7FE0,0010) and the X-Ray beam intensity. Enumerated Values; 1 = Lower pixel values correspond to less X-Ray beam intensity -1 = Higher pixel values correspond to less X-Ray beam intensity See C.8.11.3.1.2 for further explanation.
Rescale Intercept	(0028,1052)	1	The value b in the relationship between stored values (SV) in Pixel Data (7FE0,0010) and the output units specified in Rescale Type (0028,1054). Output units = $m \cdot SV + b$. Enumerated Value: 0 See C.8.11.3.1.2 for further explanation.
Rescale Slope	(0028,1053)	1	m in the equation specified by Rescale Intercept (0028,1052). Enumerated Value: 1 See C.8.11.3.1.2 for further explanation.
Rescale Type	(0028,1054)	1	Specifies the output units of Rescale Slope (0028,1053) and Rescale Intercept (0028,1052). Enumerated Value: US = Unspecified See C.8.11.3.1.2 for further explanation.

Presentation LUT Shape	(2050,0020)	1	<p>Specifies an identity transformation for the Presentation LUT, other than to account for the value of Photometric Interpretation (0028,0004), such that the output of all grayscale transformations defined in the IOD containing this Module are defined to be P-Values.</p> <p>Enumerated Values:</p> <p>IDENTITY - output is in P-Values - shall be used if Photometric Interpretation (0028,0004) is MONOCHROME2.</p> <p>INVERSE - output after inversion is in P-Values - shall be used if Photometric Interpretation (0028,0004) is MONOCHROME1.</p> <p>See C.8.11.3.1.2 for further explanation.</p>
Lossy Image Compression	(0028,2110)	1	<p>Specifies whether an Image has undergone lossy compression. Enumerated Values:</p> <p>00 = Image has NOT been subjected to lossy compression.</p> <p>01 = Image has been subjected to lossy compression.</p> <p>See C.7.6.1.1.5 for further explanation.</p>
Lossy Image Compression Ratio	(0028,2112)	1C	<p>See C.7.6.1.1.5 for further explanation.</p> <p>Required if Lossy Compression has been performed on the Image.</p>
Derivation Description	(0008,2111)	3	<p>A text description of how this image was derived.</p> <p>See C.8.11.3.1.4 for further explanation.</p>
Acquisition Device Processing Description	(0018,1400)	3	<p>Indicates any visual processing performed on the images prior to exchange.</p> <p>See C.8.11.3.1.3 for further explanation.</p>
Acquisition Device Processing Code	(0018,1401)	3	<p>Code representing the device-specific processing associated with the image (e.g. Organ Filtering code)</p> <p>Note: This Code is manufacturer specific but provides useful annotation information to the knowledgeable observer.</p>
Patient Orientation	(0020,0020)	1	<p>Patient direction of the rows and columns of the image.</p> <p>See C.7.6.1.1.1 for further explanation.</p>

Calibration Image	(0050,0004)	3	Indicates whether a reference object (phantom) of known size is present in the image and was used for calibration. Enumerated Values: YES NO Device is identified using the Device module. See C.7.6.12 for further explanation.
Burned In Annotation	(0028,0301)	1	Indicates whether or not image contains sufficient burned in annotation to identify the patient and date the image was acquired. Enumerated Values: YES NO
VOI LUT Sequence	(0028,3010)	1C	Defines a sequence of VOI LUTs. See C.8.11.3.1.5 for further explanation. Required if Presentation Intent Type (0008,0068) is FOR PRESENTATION and Window Center (0028,1050) is not present. May also be present if Window Center (0028,1050) is present.
>LUT Descriptor	(0028,3002)	1C	Specifies the format of the LUT Data in this Sequence. See See C.8.11.3.1.5 for further explanation. Required if the VOI LUT Sequence (0028,3010) is sent.
>LUT Explanation	(0028,3003)	3	Free form text explanation of the meaning of the LUT.
>LUT Data	(0028,3006)	1C	LUT Data in this Sequence. Required if the VOI LUT Sequence (0028,3010) is sent.
Window Center	(0028,1050)	1C	Defines a Window Center for display. See See C.8.11.3.1.5 for further explanation. Required if Presentation Intent Type (0008,0068) is FOR PRESENTATION and VOI LUT Sequence (0028, 3010) is not present. May also be present if VOI LUT Sequence (0028, 3010) is present.
Window Width	(0028,1051)	1C	Window Width for display. See C.8.11.3.1.5 for further explanation. Required if Window Center (0028,1050) is sent.

Window Center & Width Explanation	(0028,1055)	3	Free form explanation of the meaning of the Window Center and Width. Multiple values correspond to multiple Window Center and Width values.
-----------------------------------	-------------	---	---

C.8.11.3.1 DX Image Attribute Descriptions

C.8.11.3.1.1 Image Type

Value 1 shall identify the Pixel Data Characteristics in accordance with Section C.7.6.1.1.2 where the Enumerated Values are defined to be ORIGINAL or DERIVED.

Note: DX images may still be of type ORIGINAL rather than DERIVED despite the possibility that they may have undergone some processing. In this case a DERIVED image would have undergone yet further processing to make it substantially different from the original.

Value 2 shall identify the Patient Examination Characteristics in accordance with Section C.7.6.1.1.2 where the Enumerated Values are defined to be PRIMARY or SECONDARY.

Note: DX images generally use PRIMARY value for images captured from patient exposure.

If images from the same exposure exist with different Values of Image Type, then they shall have different SOP Instance UIDs.

Note: Source Image Sequence (0008,2112) may be used to relate these images.

Value 3 (which is specific to the IOD) shall be present and have zero length (null value).

Other Values (4 and beyond) are optional and implementation specific.

C.8.11.3.1.2 Pixel Intensity Relationship and Grayscale Transformations

Pixel Intensity Relationship (0028,1040) and Pixel Intensity Relationship Sign (0028,1041) describe how the stored pixel values in Pixel Data (7FE0,0010) are related to the X-Ray beam intensity incident on the detector.

They do not define a transformation intended to be applied to the pixel data for presentation.

Note: For example, if Pixel Intensity Relationship (0028,1040) is LIN and Pixel Intensity Relationship Sign (0028,1041) is -1, then lower values of Pixel Data (7FE0,0010) indicate higher X-Ray beam intensities corresponding to less radiographically dense regions projected on the image such as through air, and higher values of Pixel Data (7FE0,0010) indicate lower X-Ray beam intensities corresponding to more radiographically dense regions projected on the image such as through bone and radio-opaque contrast agents.

The transformation to be applied to the pixel data for presentation is defined by the successive application of the conceptual Modality LUT, the VOI Attributes and the conceptual Presentation LUT. This shall result in the output of P-Values.

Rescale Slope (0028,1052) and Rescale Intercept (0028,1053) define a linear subset of a conceptual Modality LUT transformation. For IODs that include this Module, these Attributes define an identity transformation. IODs that include the DX Image Module shall not include the Modality LUT Module.

The Presentation LUT Shape (2050,0020) defines a subset of a conceptual Presentation LUT. For IODs that include this Module, this Attribute defines an identity transformation or inverse identity transformation. IODs that include the DX Image Module shall not include the Presentation LUT Module.

Photometric Interpretation (0028,0004) indicates whether lower values that are the output of the VOI Attributes should be displayed as darker or lighter. Since the output of the equivalent of a conceptual Presentation LUT is in P-Values, which are defined in PS 3.14 such that lower values correspond to lower luminance levels, then the definition of the Presentation LUT Shape (2050,0020), otherwise intended to be an identity transformation, must take into account the effect of the value specified for Photometric Interpretation (0028,0004).

Note: Regardless of the values of Pixel Intensity Relationship (0028,1040) and Pixel Intensity Relationship Sign (0028,1041), the grayscale transformations to be applied to the Pixel Data (7FE0,0010) are defined by the equivalent of the Modality LUT (Rescale Slope (0028,1052) and Rescale Intercept (0028,1053)), Value of Interest Attributes, Photometric Interpretation (0028,0004) and the equivalent of the Presentation LUT (Presentation LUT Shape (2050,0020)). However, the combination of the grayscale transformations and the description of the pixel intensity relationship, together define whether, for example, air is expected to be displayed as black or white.

C.8.11.3.1.3 Acquisition Device Processing Description

Acquisition Device Processing Description (0018,1400) provides some indication in human readable text of the digital processing on the images before exchange. Examples of this processing are: edge enhanced, subtracted, time filtered, gamma corrected, convolved (spatially filtered).

C.8.11.3.1.4 Derivation Description

If an Image is identified to be a Derived image in Image Type (0008,0008), Derivation Description (0008,2111) is an optional and implementation specific text description of the way the image was derived from an original image. As applied to DX images, it may be used to describe derivation operations such as edge enhancement, temporal filtering, digital subtraction, or other linear and non-linear transformations.

C.8.11.3.1.5 VOI Attributes

The Attributes of the VOI LUT Module (C.11.2) are specialized in the DX Image Module.

Window Center (0028,1050) and Window Width (0028,1051) specify a linear conversion from the output of the (conceptual) Modality LUT values to the input to the (conceptual) Presentation LUT. Window Center contains the value that is the center of the window. Window Width contains the width of the window.

The application of the Window Center (0028,1050) and Window Width (0028,1051) shall not produce a signed result.

Note: If the Presentation LUT Shape (2050,0020) is IDENTITY, then the result of applying the Window Center (0028,1050) and Window Width (0028,1051) is P-Values.

If multiple values are present, both Attributes shall have the same number of values and shall be considered as pairs. Multiple values indicate that multiple alternative views should be presented.

The VOI LUT Sequence specifies a (potentially non-linear) conversion from the output of the (conceptual) Modality LUT values to the input to the (conceptual) Presentation LUT.

If multiple items are present in VOI LUT Sequence (0028,3010), only one shall be applied. Multiple items indicate that multiple alternative views should be presented.

If any VOI LUT Attributes are included by an Image, a Window Width and Window Center or the VOI LUT Table, but not both, shall be applied to the Image for display. Inclusion of both indicates that multiple alternative views should be presented.

The three values of the LUT Descriptor (0028,3002) describe the format of the LUT Data (0028,3006).

The first value is the number of entries in the lookup table.

The second value is the first stored pixel value mapped. This pixel value is mapped to the first entry in the LUT. All image pixel values less than the first value mapped are also mapped to the first entry in the LUT Data. An image pixel value one greater than the first value mapped is mapped to the second entry in the LUT Data. Subsequent image pixel values are mapped to the subsequent entries in the LUT Data up to an image pixel value equal to number of entries + first value mapped - 1 which is mapped to the last entry in the LUT Data. Image pixel values greater than number of entries + first value mapped are also mapped to the last entry in the LUT Data.

The third value specifies the number of bits for each entry in the LUT Data (analogous to "bits stored"). It shall be between 10-16. The LUT Data shall be stored in a format equivalent to 16 "bits allocated" and "high bit" equal to "bits stored" - 1. The third value conveys the range of LUT entry values. These unsigned LUT entry values shall range between 0 and $2^n - 1$, where n is the third value of the LUT Descriptor.

- Notes:
1. The third value is restricted in the VOI LUT Module to 8 or 16 but is specialized here.
 2. The first and second values are not specialized and are the same as in the VOI LUT Module.

The LUT Data (0028,3006) contains the LUT entry values.

C.8.11.4 DX Detector Module

Table C.8-67 contains IOD Attributes that describe a DX detector.

**Table C.8-67
DX DETECTOR MODULE ATTRIBUTES**

Attribute Name	Tag	Type	Attribute Description
Detector Type	(0018,7004)	2	The type of detector used to acquire this image. Defined Terms: DIRECT = X-Ray photoconductor SCINTILLATOR = Phosphor used STORAGE = Storage phosphor FILM = Scanned film/screen
Detector Configuration	(0018,7005)	3	The physical configuration of the detector. Defined Terms: AREA = single or tiled detector SLOT = scanned slot, slit or spot
Detector Description	(0018,7006)	3	Free text description of detector.

Detector Mode	(0018,7008)	3	Text description of operating mode of detector (implementation specific).
Detector ID	(0018,700A)	3	The ID or serial number of the detector used to acquire this image.
Date of Last Detector Calibration	(0018,700C)	3	The date on which the detector used to acquire this image as identified in Detector ID (0018,700A) was last calibrated.
Time of Last Detector Calibration	(0018,700E)	3	The time at which the detector used to acquire this image as identified in Detector ID (0018,700A) was last calibrated.
Exposures on Detector Since Last Calibration	(0018,7010)	3	Total number of X-Ray exposures that have been made on the detector used to acquire this image as identified in Detector ID (0018,700A) since it was calibrated.
Exposures on Detector Since Manufactured	(0018,7011)	3	Total number of X-Ray exposures that have been made on the detector used to acquire this image as identified in Detector ID (0018,700A) since it was manufactured.
Detector Time Since Last Exposure	(0018,7012)	3	Time in Seconds since an exposure was last made on this detector prior to the acquisition of this image.
Detector Active Time	(0018,7014)	3	Time in mSec that the detector is active during acquisition of this image. Note: This activation window overlaps the time of the X-Ray exposure as defined by Exposure Time (0018,1150) and Detector Activation Offset From Exposure (0018,7016).
Detector Activation Offset From Exposure	(0018,7016)	3	Offset time in mSec that the detector becomes active after the X-Ray beam is turned on during acquisition of this image. May be negative.
Detector Binning	(0018,701A)	3	Number of active detectors used to generate a single pixel. Specified as number of row detectors per pixel then column.
Detector Conditions Nominal Flag	(0018,7000)	3	Whether or not the detector is operating within normal tolerances during this image acquisition. Enumerated Values: YES NO Note: This flag is intended to indicate whether or not there may have been some compromise of the diagnostic quality of the image due to some condition such as over-temperature, etc.

Detector Temperature	(0018,7001)	3	Detector temperature during exposure in degrees Celsius.
Sensitivity	(0018,6000)	3	Detector sensitivity in manufacturer specific units. Note: This value is intended to provide a single location where manufacturer specific information can be found for annotation on a display or film, that has meaning to a knowledgeable observer.
Field of View Shape	(0018,1147)	3	Shape of the Field of View, that is the image pixels stored in Pixel Data (7FE0,0010). Enumerated Values: RECTANGLE ROUND HEXAGONAL
Field of View Dimension(s)	(0018,1149)	3	Dimensions in mm of the Field of View, that is the image pixels stored in Pixel Data (7FE0,0010). If Field of View Shape (0018,1147) is: RECTANGLE: row dimension followed by column. ROUND: diameter. HEXAGONAL: diameter of a circumscribed circle.
Field of View Origin	(0018,7030)	1C	Offset of the TLHC of a rectangle circumscribing the Field of View, that is the image pixels stored in Pixel Data (7FE0,0010), before rotation or flipping, from the TLHC of the physical detector area measured in physical detector pixels as a row offset followed by a column offset. Required if Field of View Rotation (0018,7032) or Field of View Horizontal Flip (0018,7034) is present. See C.8.11.4.1.1 for further explanation.
Field of View Rotation	(0018,7032)	1C	Clockwise rotation in degrees of Field of View, that is the image pixels stored in Pixel Data (7FE0,0010), relative to the physical detector. Enumerated Values: 0, 90, 180, 270 Required if Field of View Horizontal Flip (0018,7034) is present. See C.8.11.4.1.1 for further explanation.

Field of View Horizontal Flip	(0018,7034)	1C	<p>Whether or not a horizontal flip has been applied to the Field of View, that is the image pixels stored in Pixel Data (7FE0,0010), after rotation relative to the physical detector as described in Field of View Rotation (0018,7032).</p> <p>Enumerated Values:</p> <p style="text-align: center;">NO YES</p> <p>Required if Field of View Rotation (0018,7032) is present.</p> <p>See C.8.11.4.1.1 for further explanation.</p>
Imager Pixel Spacing	(0018,1164)	1	<p>Physical distance measured at the front plane of the detector housing between the center of each image pixel specified by a numeric pair - row spacing value(delimiter) column spacing value in mm.</p>
Detector Element Physical Size	(0018,7020)	3	<p>Physical dimensions of each detector element that comprises the detector matrix, in mm.</p> <p>Expressed as row dimension followed by column.</p> <p>Note: This may not be the same as Detector Element Spacing (0018,7022) due to the presence of spacing material between detector elements.</p>
Detector Element Spacing	(0018,7022)	3	<p>Physical distance between the center of each detector element, specified by a numeric pair - row spacing value(delimiter) column spacing value in mm.</p> <p>Note: This may not be the same as the Imager Pixel Spacing (0018,1164), and should not be assumed to describe the stored image.</p>
Detector Active Shape	(0018,7024)	3	<p>Shape of the active area.</p> <p>Enumerated Value:</p> <p style="text-align: center;">RECTANGLE ROUND HEXAGONAL</p> <p>Note: This may be different from the Field of View Shape (0018,1147), and should not be assumed to describe the stored image.</p>

Detector Active Dimension(s)	(0018,7026)	3	Dimensions in mm of the active area. If Detector Active Shape(0018,7024) is: RECTANGLE: row dimension followed by column. ROUND: diameter. HEXAGONAL: diameter of a circumscribed circle. Note: This may be different from the Field of View Dimensions (0018,1149), and should not be assumed to describe the stored image.
Detector Active Origin	(0018,7028)	3	Offset of the TLHC of a rectangle circumscribing the active detector area from the TLHC of a rectangle circumscribing the physical detector area, measured in physical detector pixels as a row offset followed by a column offset. See C.8.11.4.1.1 for further explanation.

C.8.11.4.1 DX Detector Attribute Descriptions

C.8.11.4.1.1 Physical, Active, Field of View, Exposed and Displayed Areas

The relationship between the Physical Detector Area, the Active Detector Area, the Field of View (what is stored in the Pixel Data (7FE0,0010)), the Exposed Area (after X-Ray Collimation) and the Displayed Area is illustrated in the following diagrams.

Note: Some of these Attributes relate the image data to manufacturer specific characteristics of the detector that may be used for quality control purposes, e.g. correlation of image artifacts with a detector defect map, analysis of noise performance, etc.

The Displayed Area is defined in pixel coordinates relative to the stored image pixel values by the Attributes of the Display Shutter Module (see section C.7.6.11). If this Module is not present or supported, then the Displayed Area is equal to the Field of View.

The Exposed Area is defined in pixel coordinates relative to the stored image pixel values by the Attributes of the X-Ray Collimator Module (see section C.8.7.3).

For the Digital X-Ray IODs, the Field of View is usually rectangular in shape and the same size as the stored Pixel Data (7FE0,0010). The shape and size of the Field of View and the spacing of the pixels are defined by the following Attributes:

- Field of View Shape (0018,1147),
- Field of View Dimensions (0018,1149),
- Imager Pixel Spacing (0018,1164),
- Rows (0028,0010),
- Columns (0028,0011)

The following Attributes define the relationship of the Field of View to the Physical Detector Area:

- Field of View Origin (0018,7030),
- Field of View Rotation (0018,7032),
- Field of View Horizontal Flip (0018,7034).

For the Digital X-Ray IODs, the Active Area, i.e. that part of the detector matrix that was activated for this exposure, is usually rectangular in shape. The shape and size of the Active Area and the size and spacing of the detectors are defined by the following Attributes:

- Detector Active Shape (0018,7024),
- Detector Active Dimensions (0018,7026),
- Detector Element Physical Size (0018,7020),
- Detector Element Spacing (0018,7022).

- Notes:
1. The Detector Element Physical Size (0018,7020) and Detector Element Spacing (0018,7022) may be different if there are insensitive regions between each detector.
 2. This model of description is not able to accurately describe multiple matrices of detectors that are "tiled" to produce a single image.

The following optional Attribute defines the relationship of the Active Area to the Physical Detector Area:

- Detector Active Origin (0018,7028).

The relationship between detectors and stored image pixels is defined by Detector Binning (0018,701A) which specifies how many detectors, in each of the row and column directions, contribute to (are pooled or averaged to form) a single stored image pixel.

- Note: Detector Binning (0018,701A) may have values less than one if sub-sampling is used to derive an image with higher spatial resolution than the detector matrix.

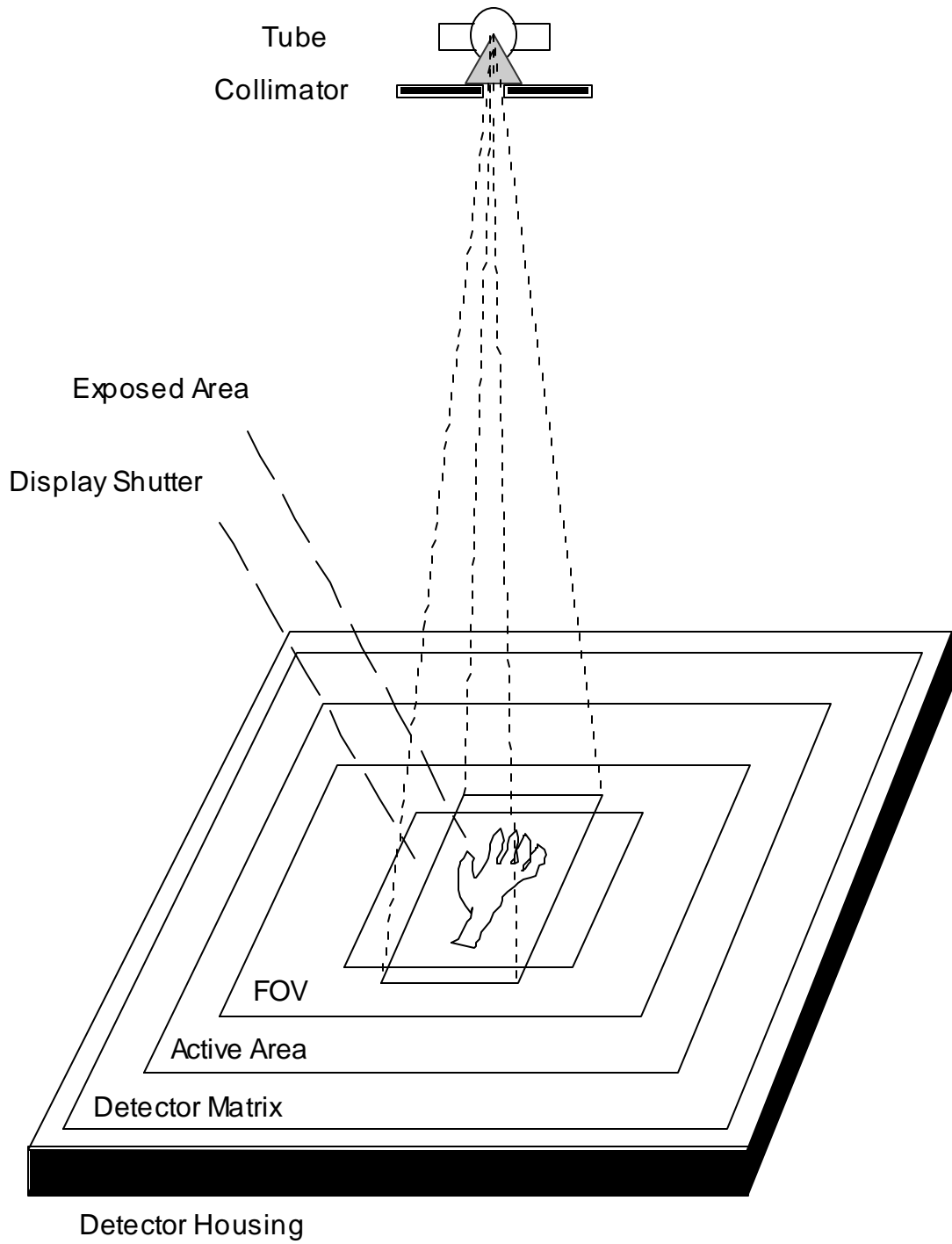

Figure C.8-6
Explanation of DX Detector Attributes

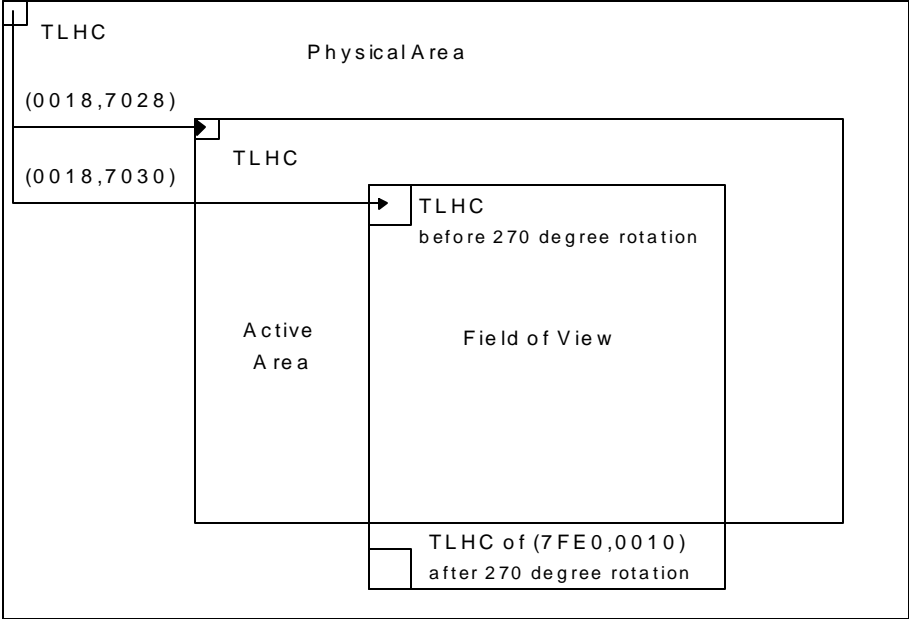
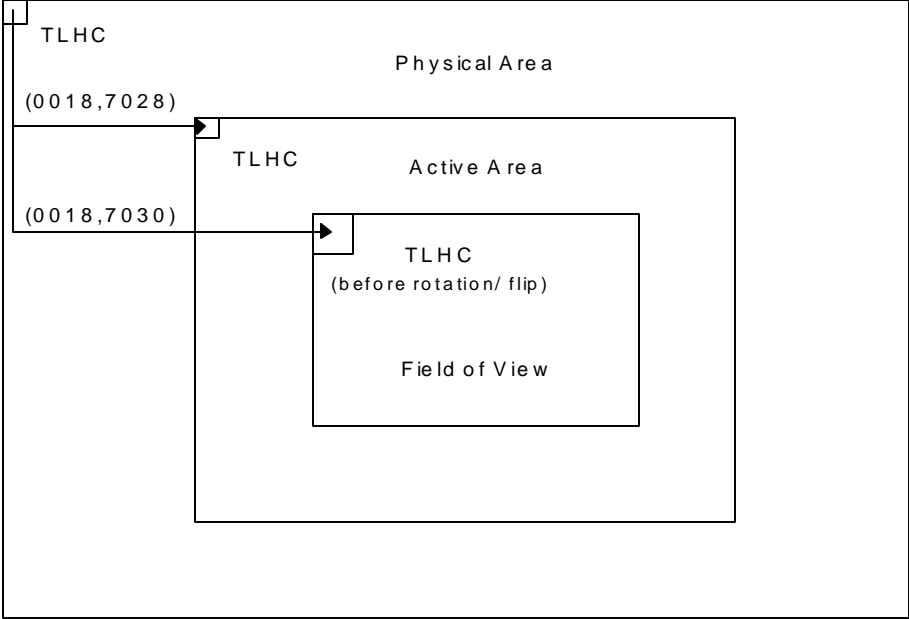

Figure C.8-7
Explanation of DX Detector Attributes

C.8.11.5 DX Positioning Module

Table C.8-68 contains IOD Attributes that describe the positioning used in acquiring Digital X-Ray Images.

**Table C.8-68
DX POSITIONING MODULE ATTRIBUTES**

Attribute Name	Tag	Type	Attribute Description
Projection Eponymous Name Code Sequence	(0018,5104)	3	<p>A Sequence that describes the radiographic method of patient, tube and detector positioning to achieve a well described projection or view.</p> <p>Only a single Item shall be permitted in this Sequence.</p> <p>Shall be consistent with the other Attributes in this Module, if present, but may more specifically describe the image acquisition.</p>
<i>>Include 'Code Sequence Macro' Table 8.8-1.</i>		Baseline Context ID 4012	
Patient Position	(0018,5100)	3	<p>Description of imaging subject's position relative to the equipment.</p> <p>See C.7.3.1.1.2 for Defined Terms and further explanation.</p> <p>If present, shall be consistent with Patient Gantry Relationship Code Sequence (0054,0414) and Patient Orientation Modifier Code Sequence (0054,0412).</p>
View Position	(0018,5101)	3	<p>Radiographic view of the image relative to the imaging subject's orientation.</p> <p>Shall be consistent with View Code Sequence (0054,0220). See C.8.11.5.1.1 for further explanation.</p>
View Code Sequence	(0054,0220)	3	<p>Sequence that describes the projection of the anatomic region of interest on the image receptor.</p> <p>Note: It is strongly recommended that this Attribute be present, in order to ensure that images may be positioned correctly relative to one another for display.</p> <p>Shall be consistent with View Position (0018,5101). See C.8.11.5.1.1 for further explanation.</p> <p>Only a single Item shall be permitted in this Sequence.</p>
<i>>Include 'Code Sequence Macro' Table 8.8-1.</i>		Baseline Context ID 4010	

>View Modifier Code Sequence	(0054,0222)	3	View modifier. Zero or more Items may be included in this Sequence.
>>Include 'Code Sequence Macro' Table 8.8-1.		Baseline Context ID 4011	
Patient Orientation Code Sequence	(0054,0410)	3	Sequence that describes the orientation of the patient with respect to gravity. See C.8.11.5.1.3 for further explanation. Only a single Item shall be permitted in this Sequence.
>Include 'Code Sequence Macro' Table 8.8-1.		Baseline Context ID 19	
> Patient Orientation Modifier Code Sequence	(0054,0412)	3	Patient Orientation Modifier. Required if needed to fully specify the orientation of the patient with respect to gravity. Only a single Item shall be permitted in this Sequence.
>>Include 'Code Sequence Macro' Table 8.8-1.		Baseline Context ID 20	
Patient Gantry Relationship Code Sequence	(0054,0414)	3	Sequence which describes the orientation of the patient with respect to the gantry. Only a single Item shall be permitted in this Sequence.
>Include 'Code Sequence Macro' Table 8.8-1.		Baseline Context ID 21	

Distance Source to Patient	(0018,1111)	3	<p>Distance in mm from source to the table, support or bucky side that is closest to the Imaging Subject, as measured along the central ray of the X-Ray beam.</p> <p>Note:</p> <ol style="list-style-type: none"> 1. This definition is less useful in terms of estimating geometric magnification than a measurement to a defined point within the Imaging Subject, but accounts for what is realistically measurable in an automated fashion in a clinical setting. 2. This measurement does not take into account any air gap between the Imaging Subject and the "front" of the table or bucky. 3. If the detector is not mounted in a table or bucky, then the actual position relative to the patient is implementation or operator defined. 4. This value is traditionally referred to as Source Object Distance (SOD).
Distance Source to Detector	(0018,1110)	3	<p>Distance in mm from source to detector center.</p> <p>Note: This value is traditionally referred to as Source Image Distance (SID).</p>
Estimated Radiographic Magnification Factor	(0018,1114)	3	<p>Ratio of Source Image Distance (SID) over Source Object Distance (SOD).</p>
Positioner Type	(0018,1508)	2	<p>Defined Terms:</p> <p>CARM COLUMN MAMMOGRAPHIC PANORAMIC CEPHALOSTAT RIGID NONE</p> <p>Notes:</p> <ol style="list-style-type: none"> 1. The term CARM can apply to any positioner with 2 degrees of freedom of rotation of the X-Ray beam about the Imaging Subject. 2. The term COLUMN can apply to any positioner with 1 degree of freedom of rotation of the X-Ray beam about the Imaging Subject.

Positioner Primary Angle	(0018,1510)	3	<p>Position of the X-Ray beam about the patient from the RAO to LAO direction where movement from RAO to vertical is positive, if Positioner Type (0018,1508) is CARM.</p> <p>See C.8.7.5 XA Positioner Module for further explanation if Positioner Type (0018,1508) is CARM.</p> <p>See C.8.11.6 Mammography Image Module for explanation if Positioner Type (0018,1508) is MAMMOGRAPHIC.</p>
Positioner Secondary Angle	(0018,1511)	3	<p>Position of the X-Ray beam about the patient from the CAU to CRA direction where movement from CAU to vertical is positive, if Positioner Type (0018,1508) is CARM.</p> <p>See C.8.7.5 XA Positioner Module for further explanation if Positioner Type (0018,1508) is CARM.</p> <p>See C.8.11.6 Mammography Image Module for explanation if Positioner Type (0018,1508) is MAMMOGRAPHIC.</p>
Detector Primary Angle	(0018,1530)	3	<p>Angle of the X-Ray beam in the row direction in degrees relative to the normal to the detector plane. Positive values indicate that the X-Ray beam is tilted toward higher numbered columns. Negative values indicate that the X-Ray beam is tilted toward lower numbered columns.</p> <p>See C.8.7.5 XA Positioner Module for further explanation.</p>
Detector Secondary Angle	(0018,1531)	3	<p>Angle of the X-Ray beam in the column direction in degrees relative to the normal to the detector plane. Positive values indicate that the X-Ray beam is tilted toward lower numbered rows. Negative values indicate that the X-Ray beam is tilted toward higher numbered rows.</p> <p>See C.8.7.5 XA Positioner Module for further explanation.</p>
Column Angulation	(0018,1450)	3	<p>Angle of the X-Ray beam in degree relative to an orthogonal axis to the detector plane. Positive values indicate that the tilt is toward the head of the table.</p> <p>Note: The detector plane is assumed to be parallel to the table plane.</p> <p>Only meaningful if Positioner Type (0018,1508) is COLUMN.</p>

Table Type	(0018,113A)	3	Defined Terms: FIXED TILTING NONE
Table Angle	(0018,1138)	3	Angle of table plane in degrees relative to horizontal plane [Gravity plane]. Positive values indicate that the head of the table is upward. Only meaningful if Table Type (0018,113A) is TILTING.
Body Part Thickness	(0018,11A0)	3	The average thickness in mm of the body part examined when compressed, if compression has been applied during exposure.
Compression Force	(0018,11A2)	3	The compression force applied to the body part during exposure, measured in Newtons.

C.8.11.5.1.1 View Code Sequence

View Code Sequence (0054,0220) replaces the function of View Position (0018,5101), and describes the radiographic view of the image relative to the real-world patient orientation as described in Annex E.

C.8.11.5.1.3 Patient Orientation Code Sequence

This Attribute is not related to Patient Orientation (0020,0020) and conveys a different concept entirely.

C.8.11.6 Mammography Series Module

Table C.8-69 specifies the Attributes which identify and describe general information about a Digital Mammography Series.

**Table C.8-69
MAMMOGRAPHY SERIES MODULE ATTRIBUTES**

Attribute Name	Tag	Type	Attribute Description
Modality	(0008,0060)	1	Type of equipment that originally acquired the data used to create the images in this Series. Enumerated Value: MG See section C.7.3.1.1.1 for further explanation.

C.8.11.7 Mammography Image Module

Table C.8-70 contains IOD Attributes that describe a Digital Mammography X-Ray Image including its acquisition and positioning.

**Table C.8-70
MAMMOGRAPHY IMAGE MODULE ATTRIBUTES**

Attribute Name	Tag	Type	Attribute Description
Positioner Type	(0018,1508)	1	Enumerated Values: MAMMOGRAPHIC NONE
Positioner Primary Angle	(0018,1510)	3	Position in degrees of the X-Ray beam in the coronal anatomical plane as if the patient were standing where movement of the X-Ray source from right to vertical is positive, and vertical is zero.
Positioner Secondary Angle	(0018,1511)	3	Position in degrees of the X-Ray beam in the sagittal anatomical plane as if the patient were standing where movement of the X-Ray source from anterior to posterior is positive, and vertical is zero.
Image Laterality	(0020,0062)	1	Laterality of the region examined. Enumerated Values: R = right L = left B = both (e.g. cleavage)
Organ Exposed	(0040,0318)	1	Organ to which Organ Dose (0040,0316) applies. Enumerated Value: BREAST Note: In the Mammography IOD, Organ Dose (0040,0316) refers to the mean glandular dose.
Implant Present	(0028,1300)	3	Whether or not an implant is present. Enumerated Values: YES NO
Partial View	(0028,1350)	3	Indicates whether this image is a partial view, that is a subset of a single view of the breast. Enumerated Values: YES, NO If this Attribute is absent, then the image may or may not be a partial view. Note: This may occur when a breast is larger than the active area of the detector.

Partial View Description	(0028,1351)	3	Free text description of the portion of the breast captured in a partial view image.
Anatomic Region Sequence	(0008,2218)	1	Sequence that identifies the anatomic region of interest in this image. Only a single Item shall be permitted in this Sequence.
>Include 'Code Sequence Macro' Table 8.8-1.		Enumerated Value for Context ID is 4013.	
View Code Sequence	(0054,0220)	1	Sequence that describes the projection of the anatomic region of interest on the image receptor. Only a single Item shall be permitted in this Sequence.
>Include 'Code Sequence Macro' Table 8.8-1.		Enumerated Value for Context ID is 4014.	
>View Modifier Code Sequence	(0054,0222)	2	View modifier. Zero or more Items may be included in this Sequence.
>>Include 'Code Sequence Macro' Table 8.8-1.		Enumerated Value for Context ID is 4015.	

C.8.11.8 Intra-oral Series Module

Table C.8-71 specifies the Attributes which identify and describe general information about a Digital Intra-oral X-Ray Series.

**Table C.8-71
INTRA-ORAL SERIES MODULE ATTRIBUTES**

Attribute Name	Tag	Type	Attribute Description
Modality	(0008,0060)	1	Type of equipment that originally acquired the data used to create the images in this Series. Enumerated Values: IO See section C.7.3.1.1.1 for further explanation.

C.8.11.9 Intra-oral Image Module

Table C.8-72 contains IOD Attributes that describe a Digital Intra-oral X-Ray Image including its acquisition and positioning.

**Table C.8-72
INTRA-ORAL IMAGE MODULE ATTRIBUTES**

Attribute Name	Tag	Type	Attribute Description
Positioner Type	(0018,1508)	1	Enumerated Values: NONE CEPHALOSTAT RIGID

Image Laterality	(0020,0062)	1	Laterality of the region examined. Enumerated Values: R = right L = left B = both (i.e. midline)
Anatomic Region Sequence	(0008,2218)	1	Sequence that identifies the anatomic region of interest in this image. Only a single Item shall be permitted in this Sequence.
>Include 'Code Sequence Macro' Table 8.8-1.		Enumerated Value for Context ID is 4016.	
>Anatomic Region Modifier Sequence	(0008,2220)	1C	Sequence that refines the anatomic region of interest in this image. Required if Primary Anatomic Structure Sequence (0008,2228) is not sent. Only a single Item shall be permitted in this Sequence.
>>Include 'Code Sequence Macro' Table 8.8-1.		Enumerated Value for Context ID is 4017.	
Primary Anatomic Structure Sequence	(0008,2228)	1C	Sequence that describes the primary anatomic structures of interest in this image. See C.11.8.9.1.1 for further explanation. Required if Anatomic Region Modifier Sequence (0008,2220) is not sent. One or more Items may be included in this Sequence.
>Include 'Code Sequence Macro' Table 8.8-1.		Enumerated Value for Context ID is 4018 or 4019. See C.11.8.9.1.1 for further explanation.	

C.8.11.9.1 Intra-oral Image Attribute Descriptions

C.8.11.9.1.1 Primary Anatomic Structure Sequence

The Code Value (0008,0100) shall be drawn from the DICOM Content Mapping Resource, Context ID 4018, for permanent dentition, or Context ID 4019 for deciduous dentition.

These Context Groups correspond to ISO 3950-1984 which describes a designation of permanent and deciduous dentition using a two digit code, the first digit of which designates a quadrant, and the second digit a tooth.

The teeth imaged shall be listed as multiple Items in the Primary Anatomic Structure Sequence (0008,2228).

C.8.12 VL Modules

C.8.12.1 VL Image Module

Table C.8.12.1-1 specifies the Attributes that describe a VL Image produced by Endoscopy (ES), General Microscopy (GM), Automated-Stage Microscopy (SM), External-camera Photography (XC), or other VL imaging Modalities.

Table C.8.12.1-1
VL IMAGE MODULE ATTRIBUTES

Attribute Name	Tag	Type	Attribute Description
Image Type	(0008,0008)	1	Image identification characteristics. See C.8.12.1.1.6 for specialization.
Photometric Interpretation	(0028,0004)	1	Specifies the intended interpretation of the pixel data. See C.8.12.1.1.1 for specialization of this Attribute.
Bits Allocated	(0028,0100)	1	Number of bits allocated for each pixel sample. Each sample shall have the same number of bits allocated. See C.8.12.1.1.2 for specialization of this Attribute. See PS 3.5 for further explanation.
Bits Stored	(0028,0101)	1	Number of bits stored for each pixel sample. Each sample shall have the same number of bits stored. See C.8.12.1.1.2 for specialization of this Attribute. See PS 3.5 for further explanation.
High Bit	(0028,0102)	1	Most significant bit for pixel sample data. Each sample shall have the same high bit. See C.8.12.1.1.2 for specialization of this Attribute. See PS 3.5 for further explanation.
Pixel Representation	(0028,0103)	1	Data representation of the pixel samples. Each sample shall have the same pixel representation. See Section C.8.12.1.1.3 for specialization of this Attribute.
Samples per Pixel	(0028,0002)	1	Number of samples (planes) per image. See C.8.12.1.1.4 for specialization of this Attribute.
Planar Configuration	(0028,0006)	1C	Indicates whether the pixel data are sent color-by-plane or color-by-pixel. Required if Samples per Pixel (0028,0002) has a value greater than 1. See C.8.12.1.1.5 for specialization of this Attribute.
Content Time	(0008,0033)	1C	The time the image pixel data creation started. Required if the Image is part of a series in which the images are temporally related. Note: This Attribute was formerly known as Image Time.
Lossy Image Compression	(0028,2110)	2	Specifies whether an Image has undergone lossy compression. Enumerated Values: 00 = Image has NOT been subjected to lossy compression. 01 = Image has been subjected to lossy compression. See C.7.6.1.1.5

Referenced Image Sequence	(0008,1140)	1C	A sequence which provides reference to a set of Image SOP Class/Instance identifying other images significantly related to this image. Shall be used to relate each of a stereo pair to the other member of the pair. Required if Image Type (0008,0008) Value 3 is present and has a value of "STEREO L" or "STEREO R". May also be present otherwise. Encoded as a sequence of items: (0008,1150) and (0008,1155). When used to relate members of a stereo pair, only a single item shall be present.
> Referenced SOP Class UID	(0008,1150)	1C	Uniquely identifies the referenced SOP Class. Required if Referenced Image Sequence (0008,1140) is present.
> Referenced SOP Instance UID	(0008,1155)	1C	Uniquely identifies the referenced SOP Instance. Required if Referenced Image Sequence (0008,1140) is present.

C.8.12.1.1 VL Image Module Attribute Descriptions

C.8.12.1.1.1 Photometric Interpretation

The Enumerated Values of Photometric Interpretation (0028,0004) shall:

MONOCHROME2
RGB
YBR_FULL_422

C.8.12.1.1.2 Bits Allocated, Bits Stored, and High Bit

The Enumerated Value of Bits Allocated (0028,0100) shall be 8; the Enumerated Value of Bits Stored (0028,0101) shall be 8; and the Enumerated Value of High Bit (0028,0102) shall be 7.

C.8.12.1.1.3 Pixel Representation

The Enumerated Value of Pixel Representation (0028,0103) shall be 0000H.

Note: A value of 0000H signifies an unsigned integer value.

C.8.12.1.1.4 Samples per Pixel

The Enumerated Values of Samples per Pixel (0028,0002) shall be as follows: If the value of Photometric Interpretation (0028,0004) is MONOCHROME2, then the Enumerated Value of Samples per Pixel (0028,0002) shall be one (1). If the value of Photometric Interpretation (0028,0004) is RGB or YBR_FULL_422, then the Enumerated Value of Samples per Pixel (0028,0002) shall be three (3).

C.8.12.1.1.5 Planar Configuration

If present, the Enumerated Value of Planar Configuration (0028,0006) shall be 0000H. This value shall be present if Samples per Pixel (0028,0002) has a value greater than 1.

C.8.12.1.1.6 Image Type

The Image Type attribute identifies important image characteristics in a multiple valued data element. For Visible Light, Image Type is specialized as follows:

- a. Value 1 shall identify the Pixel Data Characteristics in accordance with Section C.7.6.1.1.2; Enumerated Values are: ORIGINAL and DERIVED;
- b. Value 2 shall identify the Patient Examination Characteristics in accordance with Section C.7.6.1.1.2; Enumerated Values are: PRIMARY and SECONDARY.
- c. Value 3 may be absent, but if present shall identify the members of a stereo pair, in which case Referenced Image Sequence (0008,1140) is used to identify the other member of the pair. If present, the Enumerated Values are:

STEREO L Image is the left image (relative to the observer's left) of a stereo pair acquisition;

STEREO R Image is the right image (relative to the observer's right) of a stereo pair acquisition.

- d. Other Values are implementation specific (optional).

C.8.12.2 Slide Coordinates Module

The table in this Section contains Attributes that describe Slide Coordinates. Slide Coordinates provide a means to position a robotic Microscope Stage reproducibly with respect to the pixel plane of the digital Microscope.

Note: There is no a priori correspondence of pixels to Slide Coordinates. Therefore, the geometrical symmetry point through the pixel plane of the digital microscope may not correspond to the center of a pixel. The geometrical symmetry point could be between pixels.

**Table C.8.12.2-1
Slide Coordinates Module Attributes**

Attribute Name	Tag	Type	Attribute Description
Image Center Point Coordinates Sequence	(0040,071A)	2	The coordinates of the center point of the Image in the Slide Coordinate System Frame of Reference. This sequence shall contain exactly one item. See Section C.8.12.2.1.1 of this Part for further explanation.
>X Offset in Slide Coordinate System	(0040,072A)	1C	The X offset in millimeters from the Origin of the Slide Coordinate System. See Figure C.8.12.2.1.1-1. Required if a sequence item is present.
>Y Offset in Slide Coordinate System	(0040,073A)	1C	The Y offset in millimeters from the Origin of the Slide Coordinate System. See Figure C.8.12.2.1.1-1. Required if a sequence item is present.
>Z Offset in Slide Coordinate System	(0040,074A)	2C	The Z offset in microns from the image substrate reference plane (i.e. utilized surface of a glass slide). Required if a sequence item is present.
Pixel Spacing Sequence	(0040,08D8)	3	Physical distance in the Imaging Subject, i.e. Patient or Specimen, between the center of each pixel along specified axes. One or more items may be present.
>Coordinate System Axis Code Sequence	(0040,08DA)	1C	Axis of a coordinate system. This sequence shall contain exactly one item.

>>Include 'Code Sequence Macro' Table 8.8-1			Baseline Context ID is 95.
>Numeric Value	(0040,A30A)	1C	The distance between the center-points of adjacent pixels along the axis specified by Coordinate System Axis Code Sequence (0040,08DA). Required if a sequence item is present.
>Measurement Units Code Sequence	(0040,08EA)	1C	Units of the measurement. This sequence shall contain exactly one item. Required if a sequence item is present.
>>Include 'Code Sequence Macro' Table 8.8-1			Baseline Context ID is 82.

C.8.12.2.1 VL Slide Coordinates Attribute Descriptions

C.8.12.2.1.1 Image Center Point Coordinates Sequence

This Section defines the Slide Coordinate System and specifies the Attributes that shall be used to describe the location of the center point of the Image pixel plane (as captured through a microscope) in the Slide Coordinate System Frame of Reference.

Note: In Slide Microscopy (SM), the Microscope is equipped with a moveable Stage and position sensors that enable storage of the location of the center point of the displayed image with respect to the examined Specimen.

The Stage is the part of the Microscope to which the Slide is attached for viewing. The Objective Lens is the lens that is closest to the Specimen. The Top Surface of the Slide is the surface of the Slide on which the Specimen is Mounted. The Bottom Surface of the Slide is the opposite surface. This Specification presumes that: 1) the Slide is rectangular; 2) the Top Surface of the Slide is oriented toward the Objective Lens of the Microscope; and 3) the Bottom Surface of the Slide is in perfect contact with the Microscope Stage when the Slide is attached to the Stage for viewing.

- Notes:
1. The Label of the Slide is presumed to be mounted-on or written-on the Top Surface of the Slide.
 2. Specification of the mechanical form, function, or tolerances of the Microscope are outside the scope of this Standard.

Figure C.8.12.2.1.1-1 depicts the Top Surface of the Slide on the Microscope Stage from the perspective of the Objective Lens. This is Reference Slide Orientation. The X, Y, and Z axes of the Slide Coordinate System in Reference Slide Orientation are defined as follows. The Y-axis is a line that includes the Left Edge of the Slide. The X-axis is a line that is orthogonal to the Y-axis and includes at least one point of the Specimen Edge of the Slide. The Z-axis is a line that passes through the intersection of the X-axis and Y-axis and is orthogonal to the Microscope Stage. The Origin (0,0,0) of the Slide Coordinate System is the point of intersection of the X, Y, and Z axes.

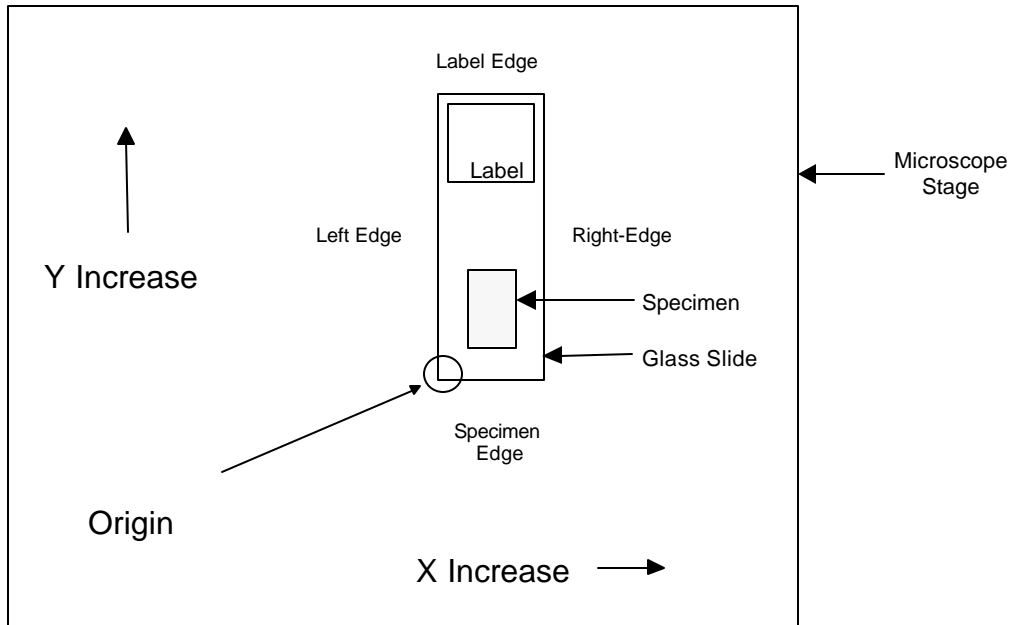

Figure C.8.12.2.1.1-1
REFERENCE SLIDE ORIENTATION

- Notes:
1. An improperly-placed coverslip or Specimen that overlaps an Edge of a Slide is not considered part of the Edge a Slide for purposes of defining the Slide Coordinate System. However, such objects may cause inaccurate positioning of the Slide on the Stage.
 2. If the Left Edge and Specimen Edge of the Slide are not orthogonal (e.g. the Slide is damaged or defective or the Specimen Edge is curvilinear), then the lower left-hand corner of the Slide may not be located at the Origin.
 3. The definitions of X, Y, and Z axes are the same for inverted microscopes, with the Top Surface of the slide (i.e. Specimen side of the Slide) still being closest to the Objective Lens.

Figure C.8.12.2.1.1-2 depicts the Z-axis center point location. The X-axis value of Image Center Point Location (0040,073A) shall increase from the Origin toward the Right Edge in Reference Slide Orientation. The Y-axis value of Image Center Point Location (0040,073A) shall increase from the Origin toward the Label Edge in Reference Slide Orientation. The Z-axis value of Image Center Point Location (0040,073A) shall be referenced as zero at the image substrate reference plane (i.e. utilized surface of a glass slide) and shall increase in a positive fashion coincident with increased distance from the substrate surface.

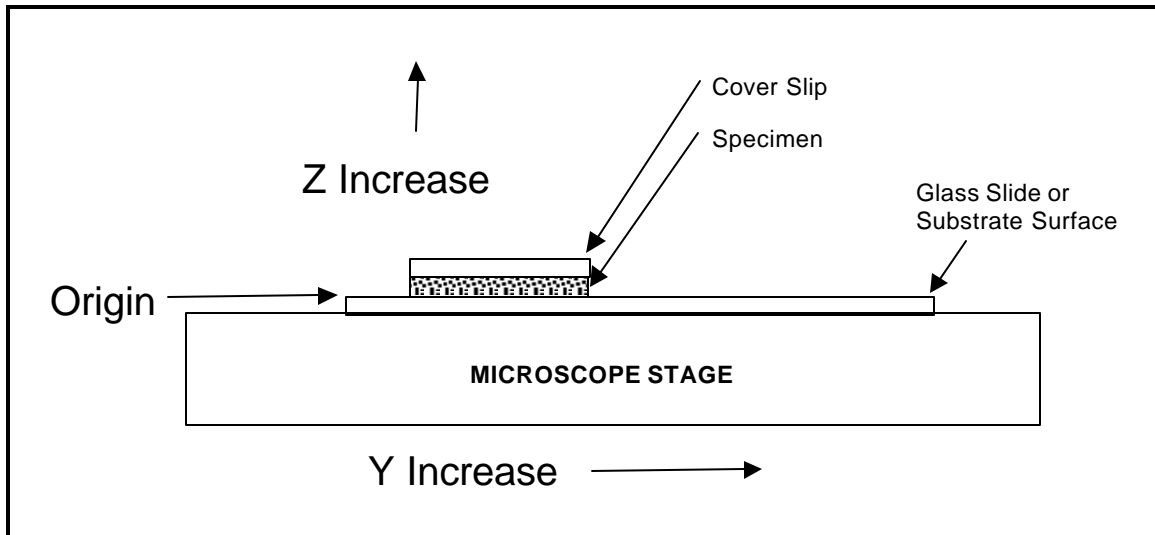

Figure C.8.12.2.1.1-2
Z-AXIS CENTER POINT LOCATION, VIEW FROM RIGHT EDGE OF SLIDE

C.9 OVERLAYS

C.9.1 Overlay identification module

Table C.9-1 contains Attributes that identify an independent Overlay; i.e. an Overlay which is handled as an independent Information Entity.

Table C.9-1
OVERLAY IDENTIFICATION MODULE ATTRIBUTES

Attribute Name	Tag	Type	Attribute Description
Overlay Number	(0020,0022)	2	A number that identifies this Overlay.
Overlay Date	(0008,0024)	3	The date the Overlay was created.
Overlay Time	(0008,0034)	3	The time the Overlay was created.
Referenced Image Sequence	(0008,1140)	3	A Sequence which provides reference to a set of Image SOP Class/Instance pairs. Uniquely identifies the images significantly related to this overlay. One or more Items may be included in this Sequence.
>Referenced SOP Class UID	(0008,1150)	1C	Uniquely identifies the referenced SOP Class. Required if Referenced Image Sequence (0008,1140) is sent.
>Referenced SOP Instance UID	(0008,1155)	1C	Uniquely identifies the referenced SOP Instance. Required if Reference Image Sequence (0008,1140) is sent.

C.9.2 Overlay plane module

Table C.9-2 contains Attributes that describe characteristics of an Overlay Plane.

An Overlay Plane describes graphics or bit-mapped text that is associated with an Image or has its own existence within a Series. It may also describe a Region of Interest in an Image.

Each Overlay Plane is one bit deep. Sixteen separate Overlay Planes may be associated with an Image or exist as Standalone Overlays in a Series.

Overlay pixel data are stored either in Overlay Data (60xx,3000) or embedded in the image pixel data in Image Pixel Data (7FE0,0010). See PS 3.5 for a description of overlay pixel data imbedded with image pixel data. See the Section Repeating Groups in PS 3.5 for a description of permitted values of 60xx.

Attributes describing display of grayscale and color overlays were defined in a previous version of the DICOM Standard. These have now been retired.

Table C.9-2
OVERLAY PLANE MODULE ATTRIBUTES

Attribute Name	Tag	Type	Attribute Description
Overlay Rows	(60xx,0010)	1	Number of Rows in Overlay.
Overlay Columns	(60xx,0011)	1	Number of Columns in Overlay.

Overlay Type	(60xx,0040)	1	Indicates whether this overlay represents a region of interest or other graphics. Enumerated Values: G = Graphics R = ROI.
Overlay Origin	(60xx,0050)	1	Location of first overlay point with respect to pixels in the image, given as row\column. The upper left pixel of the image has the coordinate 1\1. Column values greater than 1 indicate the overlay plane origin is to the right of the image origin. Row values greater than 1 indicate the overlay plane origin is below the image origin. Values less than 1 indicate the overlay plane origin is above or to the left of the image origin. Note: Values of 0\0 indicate that the overlay pixels start 1 row above and one column to the left of the image pixels.
Overlay Bits Allocated	(60xx,0100)	1	Number of Bits Allocated in the Overlay. If the overlay data are embedded in the Image Pixel Data (7FE0,0010), the value of this Attribute shall be the same as Bits Allocated (0028,0100). If the overlay data are stored in the Overlay Data (60xx,3000) Attribute, the value of this Attribute shall be 1.
Overlay Bit Position	(60xx,0102)	1	Bit in which Overlay is stored. See PS 3.5 for further explanation. If the overlay data are stored in the Overlay Data (60xx,3000) Attribute, the value of this Attribute shall be 0.
Overlay Data	(60xx,3000)	1C	Overlay pixel data. The order of pixels sent for each overlay is left to right, top to bottom, i.e., the upper left pixel is sent first followed by the remainder of the first row, followed by the first pixel of the 2nd row, then the remainder of the 2nd row and so on. Overlay data shall be contained in this Attribute or imbedded with the image pixel data in Group 7FE0. Required if overlay data are in this Group. See C.9.2.1.1 for further explanation.
Overlay Description	(60xx,0022)	3	User-defined comments about the overlay.

Overlay Subtype	(60xx,0045)	3	Defined term which identifies the intended purpose of the Overlay Type. See C.9.2.1.3 for further explanation.
Overlay Label	(60xx,1500)	3	A user defined text string which may be used to label or name this overlay.
ROI Area	(60xx,1301)	3	Number of pixels in ROI area. See C.9.2.1.2 for further explanation.
ROI Mean	(60xx,1302)	3	ROI Mean. See C.9.2.1.2 for further explanation.
ROI Standard Deviation	(60xx,1303)	3	ROI standard deviation. See C.9.2.1.2 for further explanation.

C.9.2.1 Overlay Attribute Descriptions

C.9.2.1.1 Overlay type

There are two specific types of overlays. The type is specified in this Attribute.

A Region of Interest (ROI) is a specific use of an Overlay. The overlay bits corresponding to all the pixels included in the ROI shall be set to 1. All other bits are set to 0. This is used to specify an area of the image of particular interest.

A Graphics overlay may express reference marks, graphic annotation, or bit mapped text, etc. A Graphics overlay may be used to mark the boundary of a ROI. If this is the case and the ROI statistical parameters are used, they will only refer to the pixels under the boundaries, not those in the included regions.

The overlay bits corresponding to all the pixels included in the Graphics shall be set to 1. All other bits are set to 0.

C.9.2.1.2 ROI area, ROI mean, and ROI standard deviation

These Attributes contain the statistical parameters of the ROI. The values of these parameters are for the overlay pixel values set to 1.

C.9.2.1.3 Overlay Subtype

Two Defined Terms are specified:

USER - User created graphic annotation (e.g. operator)

AUTOMATED - Machine or algorithm generated graphic annotation, such as output of a Computer Assisted Diagnosis algorithm.

Note: Additional or alternative Defined Terms may be specified in modality specific Modules, such as in the Ultrasound Image Module, C.8.5.6.1.11.

C.9.3 Multi-frame Overlay Module

Table C.9-3 specifies the Attributes of a Multi-frame overlay.

**Table C.9-3
MULTI-FRAME OVERLAY MODULE ATTRIBUTES**

Attribute Name	Tag	Type	Attribute Description
Number of Frames in Overlay	(60xx,0015)	1	Number of Frames in Overlay. Required if Overlay data contains multiple frames.
Image Frame Origin	(60xx,0051)	3	Frame number of Multi-frame Image to which this overlay applies; frames are numbered from 1.

C.9.3.1 Multi-Frame Overlay Attribute Descriptions

C.9.3.1.1 Number of frames in overlay

A Multi-frame Overlay is defined as an Overlay whose overlay data consists of a sequential set of individual Overlay frames. A Multi-frame Overlay is transmitted as a single contiguous stream of overlay data. Frame delimiters are not contained within the data stream.

Each individual frame shall be defined (and thus can be identified) by the Attributes in the Overlay Plane Module (see C.9.2).

The total number of frames contained within a Multi-frame Overlay is conveyed in the Number of Frames in Overlay (60xx,0015).

The frames within a Multi-frame Overlay shall be conveyed as a logical sequence. If Multi-frame Overlays are related to a Multi-frame Image, the order of the Overlay Frames are one to one with the order of the Image frames. Otherwise, no attribute is used to indicate the sequencing of the Overlay Frames. If Image Frame Origin (60xx,0051) is present, the Overlay frames are applied one to one to the Image frames, beginning at the indicated frame number. Otherwise, no attribute is used to indicate the sequencing of the Overlay Frames.

The Number of Frames in Overlay (60xx,0015) plus the Image Frame Origin (60xx,0051) minus 1 shall be less than or equal to the total number of frames in the Multi-frame Image.

If the Overlay data are embedded in the pixel data, then the Image Frame Origin (60xx,0051) must be 1 and the Number of Frames in Overlay (60xx,0015) must equal the number of frames in the Multi-frame Image.

C.9.4 Bi-Plane Overlay Module (Retired)

C.9.5 Basic Print Image Overlay Box Module

Table C.9-5: Basic Print Image Overlay Box Module

Attribute Name	Tag	Attribute Description
Overlay Pixel Data Sequence	(2040,0020)	A sequence which provides overlay pixel data. A single item shall be present.
>Overlay Rows	(6000,0010)	See C.9.2.
>Overlay Columns	(6000,0011)	See C.9.2.
>Overlay Origin	(6000,0050)	See C.9.2
>Overlay Bits Allocated	(6000,0100)	Number of bits allocated in the Overlay. Enumerated Value: 1

>Overlay Bit Position	(6000,0102)	Bit in which Overlay is stored. Enumerated Value: 0
>Overlay Data	(6000,3000)	Overlay data shall be contained in this Attribute.
Overlay Magnification Type	(2040,0060)	Specifies magnification type if the overlay is magnified before being superimposed on the image. Defined Terms: REPLICATE BILINEAR CUBIC
Overlay Smoothing Type	(2040,0070)	Further specifies the type of interpolation function; only valid for Overlay Magnification Type (2010,0060) = CUBIC
Overlay or Image Magnification	(2040,0072)	Specifies magnification of the overlay or image before they are superimposed. Enumerated values: IMAGE = Image is to be magnified OVERLAY = Overlay is to be magnified. See C.9.5.1
Magnify to Number of Columns	(2040,0074)	Specifies the number of columns of the overlay or image after magnification. See C.9.5.1
Overlay Foreground Density	(2040,0080)	Defines the density for pixels which correspond with overlay bit = 1. The density of the other pixels remain unchanged. Defined Terms: BLACK WHITE
Overlay Background Density	(2040,0082)	Defines the density for pixels which correspond with overlay bit = 0 that are not superimposed on the image and Combined Print Image pixels that are not part of the overlay or image Defined Terms: BLACK WHITE

Note: Since the SOP Class that uses this Module supports only one overlay plane, Group 60xx Attributes have been specified to be Group 6000 rather than 60xx.

C.9.5.1 Overlay or Image Magnification

These Attributes specify any magnification of the overlay or image that has to be performed before they are superimposed. Overlay or Image Magnification (2040,0072) specifies whether the overlay or image is to be magnified. Magnify to Number of Columns (2040,0074) specifies the number of columns of the overlay or image after magnification. If Overlay or Image Magnification has the value OVERLAY, this value shall be greater than Overlay Columns (6000,0011). If Overlay or Image Magnification has the value IMAGE, this value shall be greater than Columns (0028,0011).

Since the SOP Class that uses this Module does not provide a mechanism to specify an overlay pixel aspect ratio different than the image that refers to it, the same magnification factor shall be applied to the rows and columns of the overlay or image before they are superimposed. See Basic Print Image Overlay Box SOP Class in PS 3.4.

C.10 CURVE, GRAPHIC AND WAVEFORM

C.10.1 Curve identification module

The table in this Section contains Attributes that identify an independent Curve; i.e. a Curve which is handled as a separate information entity.

**Table C.10-1
CURVE IDENTIFICATION MODULE ATTRIBUTES**

Attribute Name	Tag	Type	Attribute Description
Curve Number	(0020,0024)	2	A number that identifies this Curve.
Curve Date	(0008,0025)	3	The date the Curve was created.
Curve Time	(0008,0035)	3	The time the Curve was created.
Referenced Image Sequence	(0008,1140)	3	A Sequence which provides reference to a set of Image SOP Class/Instance pairs. Uniquely identifies the images significantly related to this Curve. One or more Items may be included in this Sequence.
>Referenced SOP Class UID	(0008,1150)	1C	Uniquely identifies the referenced SOP Class. Required if Referenced Image Sequence (0008,1140) is sent.
>Referenced SOP Instance UID	(0008,1155)	1C	Uniquely identifies the referenced SOP Instance. Required if Reference Image Sequence (0008,1140) is sent.
Referenced Overlay Sequence	(0008,1130)	3	A Sequence which provides reference to a set of SOP Class/Instance pairs which are related independent Overlays. Uniquely identifies Overlays significantly related to this Curve. Zero or more Items may be included in this Sequence.
>Referenced SOP Class UID	(0008,1150)	1C	Uniquely identifies the referenced SOP Class. Required if Referenced Overlay Sequence (0008,1130) is sent.
>Referenced SOP Instance UID	(0008,1155)	1C	Uniquely identifies the referenced SOP Instance. Required if Reference Overlay Sequence (0008,1130) is sent.
Referenced Curve Sequence	(0008,1145)	3	A Sequence which provides reference to a set of Curve SOP Class/Instance pairs. Uniquely identifies the curves significantly related to this curve. Zero or more Items may be included in this Sequence.
>Referenced SOP Class UID	(0008,1150)	1C	Uniquely identifies the referenced SOP Class. Required if Referenced Curve Sequence (0008,1145) is sent.
>Referenced SOP Instance UID	(0008,1155)	1C	Uniquely identifies the referenced SOP Instance. Required if Referenced Curve Sequence (0008,1145) is sent.

C.10.2 Curve module

This Module defines Attributes of Curves. A Curve may or may not be related to an Image and/or a Curve.

Table C.10-2
CURVE MODULE ATTRIBUTES

Attribute Name	Tag	Type	Attribute Description
Curve Dimensions	(50xx,0005)	1	Number of dimensions for these data. The dimensions may be any number from 1 to n.
Number of Points	(50xx,0010)	1	Number of data points in this Curve
Type of Data	(50xx,0020)	1	Type of data in this curve. See C.10.2.1.1 for Defined Terms.
Data Value Representation	(50xx,0103)	1	Data representation of the curve data points. See C.10.2.2 for Enumerated Values and further explanation.
Curve Data	(50xx,3000)	1	Curve data. See C.10.2.1.4 for further explanation.
Curve Description	(50xx,0022)	3	User-defined comments about the Curve
Axis Units	(50xx,0030)	3	Units of measure for the axes. See C.10.2.1.3 for Defined Terms.
Axis Labels	(50xx,0040)	3	Text labels for each axis. One label for each axis.
Minimum Coordinate Value	(50xx,0104)	3	The minimum value in the set of data. One value for each dimension.
Maximum Coordinate Value	(50xx,0105)	3	The maximum value in the set of data. One value for each dimension.
Curve Range	(50xx,0106)	3	A minimum-maximum pair for each dimension for defining the range of the curve representation, in the same units as Axis Units.
Curve Data Descriptor	(50xx,0110)	1C	Specifies the format of the Curve Data. Required if any dimensions of the data are described by interval spacing. See C.10.2.1.5 for further explanation.
Coordinate Start Value	(50xx,0112)	1C	The starting point of a one dimensional data list. Required if Curve Data Descriptor is used. One value for each dimension. The Value Representation is given in Data Value Representation (50xx,0103).

Coordinate Step Value	(50xx,0114)	1C	The interval spacing between two successive points. Required if Curve Data Descriptor is used. One value for each dimension. The Value Representation is given in Data Value Representation (50xx,0103).
Curve Label	(50xx,2500)	3	A user defined text string which may be used to label or name this curve.
Referenced Overlay Sequence	(50xx,2600)	3	A Sequence which provides reference to a set of related overlays used to generate this curve.
>Referenced SOP Class UID	(0008,1150)	1C	Uniquely identifies the referenced SOP Class. Required if Referenced Overlay Sequence (50xx,2600) is sent.
>Referenced SOP Instance UID	(0008,1155)	1C	Uniquely identifies the referenced SOP Instance. Required if Referenced Overlay Sequence (50xx,2600) is sent.
>Referenced Overlay Group	(50xx,2610)	1C	The Group number of the related overlay. Required if Referenced Overlay Sequence (50xx,2600) is sent.

C.10.2.1 CURVE ATTRIBUTE DESCRIPTIONS

C.10.2.1.1 Type of data

A description of the Type of Data (50xx,0020) in this curve.

Defined Terms:

TAC = time activity curve

PROF = image profile

HIST = histogram

ROI = polygraphic region of interest

TABL = table of values

FILT = filter kernel

POLY = poly line

ECG = ecg data

PRESSURE = pressure data

FLOW = flow data

PHYSIO = physio data

RESP = Respiration trace

C.10.2.1.2 Data value representation

The Data Value Representation (50xx,0103) of the data in the curve. All dimensions shall have the same value representation.

Enumerated Values:

0000H = unsigned short (US)

0001H = signed short (SS)

0002H = floating point single (FL)

0003H = floating point double (FD)

0004H = signed long (SL)

C.10.2.1.3 Axis units

Axis Units (50xx,0030) are the units of measure for the axes. One value for each dimension. The order for the units is the same order as the dimensions for the curve data in Curve Data (50xx,3000).

Defined Terms:

SEC = Seconds	CNTS = Counts	MM = millimeters
PIXL = Pixels	NONE = Unitless	BPM = beats/min
CM = centimeters	CMS = centimeters/second	CM2 = cm**2
CM2S = cm**2/second	CM3 = cm**3	CM3S = cm**3/second
CMS2 = cm/second**2	DB = dB	DBS = dB/second
DEG = degrees	GM = gram	GMM2 = gram/meter**2
HZ = Hertz	IN = inch	KG = kg
LMIN = liters/minute	LMINM2 = liters/minute/meter**2	M2 = meters **2
MS2 = meters/sec**2	MLM2 = milliliters/meter**2	MILS = milliseconds
MILV = millivolts	MMHG = mmHg	PCNT = percent
LB = pound		

C.10.2.1.4 Curve data

Curve Data (50xx,3000) points in the curve, each dimension for the first point, followed by dimensions for second point, etc. For a two dimensional curve: X1,Y1,X2,Y2, etc. The Value Representation of all components of the N-tuple must be the same. The Value Representation is given in Data Value Representation (50xx,0103).

A region of interest (ROI) is defined as an N-tuple list of end points which form a closed polygraph. A two-dimensional ROI is represented as a list of value pairs; a three dimensional ROI as a list of value triplets, etc. A region of interest would normally be represented in pixel units, with the Curve Range values matching the pixel matrix of the images with which the ROI is associated. Alternatively, it is possible to define a unitized region of interest which can be applied to any size image.

A poly line is defined as an n-tuple list of end points which form a general trace not forming a closed polygraph. It is used to represent any graphic which does not fall within the normal understanding of a curve plot or region of interest. The poly line can be used to define any graphic trace.

C.10.2.1.5 Curve data descriptor, coordinate start value, coordinate step value

The Curve Data for dimension(s) containing evenly distributed data can be eliminated by using a method that defines the Coordinate Start Value and Coordinate Step Value (interval). The one dimensional data list is then calculated rather than being enumerated.

For the Curve Data Descriptor (50xx,0110) an Enumerated Value describing how each component of the N-tuple curve is described, either by points or interval spacing. One value for each dimension. Where:

0000H = Dimension component described using interval spacing

0001H = Dimension component described using values

Using interval spacing:

Dimension component(s) described by interval spacing use Attributes of Coordinate Start Value (50xx,0112), Coordinate Step Value (50xx,0114) and Number of Points (50xx,0010). The 1-dimensional data list is calculated by using a start point of Coordinate Start Value and adding the interval (Coordinate Step Value) to obtain each data point until the Number of Points is satisfied. The data points of this dimension will be absent from Curve Data (50xx,3000).

Using values:

Dimension component(s) of the N-tuple curve are listed as data points in Curve Data (50xx,3000). Data is absent from the tuple where the dimension data is defined by using the interval spacing method.

The absence of this data element means that the curve is described using points for the complete N-tuple. The interval spacing method is not used.

C.10.3 Audio module

This Module defines Attributes that describe characteristics of audio curves.

Table C.10-3
AUDIO MODULE ATTRIBUTES

Attribute Name	Tag	Type	Attribute Description
Audio Type	(50xx,2000)	1	Indicates the type of Audio Sample Data. Enumerated Values: 0000H = none 0001H = Doppler Audio 0002H = Voice Audio 0003H = Phono Audio
Audio Sample Format	(50xx,2002)	1	Format of the Audio Sample Data. Enumerated Values: 0000H = 16 bit 2's complement, interleaved per channel: channel 0 sample 0, channel 1 sample 0, channel 0 sample 1, channel 1 sample 1 0001H = 8 bit 2's complement, interleaved per channel: channel 0 sample 0, channel 1 sample 0, channel 0 sample 1, channel 1 sample 1
Number of Channels	(50xx,2004)	1	Number of Audio Channels. Enumerated Values: 0000H = mono 0001H = stereo
Number of Samples	(50xx,2006)	1	The number of audio samples for one channel. Each channel will have this many samples.
Sample Rate	(50xx,2008)	1	Number of samples per second at which audio data was acquired. The temporal axis is linear. Note: Log compression is not supported.

Total Time	(50xx,200A)	1	Length of real time that the audio data covers (in microseconds).
Audio Sample Data	(50xx,200C)	1	Audio sample data values. The amplitude representation of the audio sample data is linear. Note: Log compression is not supported.
Referenced Image Sequence	(0008,1140)	3	A Sequence which provides reference to a set of Image SOP Class/Instance pairs to which this audio applies. One or more Items may be included in this Sequence.
>Referenced SOP Class UID	(0008,1150)	1C	Uniquely identifies the referenced SOP Class. Required if Referenced Image Sequence (0008,1140) is sent.
>Referenced SOP Instance UID	(0008,1155)	1C	Uniquely identifies the referenced SOP Instance. Required if Referenced Image Sequence (0008,1140) is sent.
Audio Comments	(50xx,200E)	3	User defined comments about the audio.

C.10.3.1 AUDIO SYNCHRONIZATION

The approach being taken is to provide for audio in an elementary, basic way. Audio is typically used for voice commentary of what is found during an examination, and perhaps in a diagnosis, similar to written notes. Audio is also used to record physiological information such as Doppler audio.

The only link between audio and image time bases is alignment between audio time zero and image time zero, on a frame boundary. The time bases for each are distinct and separate.

Synchronization of audio to single frame images is not necessary, since an image is "stationary." The Audio Module need only reference the image to which it applies, using the element Referenced Image Sequence (0008,1140).

Synchronization of audio to Multi-frame loops is accomplished by referencing the loop to which the audio applies, similar to single frame images. Audio starts at time zero of the loop and continues for Attribute Total Time (50xx,200A) number of microseconds, using the time base specified in the Audio Module.

Other than synchronizing the audio at time zero of the image loop, there is no other synchronization between image and audio time bases. The audio may partially span, fully span, or overspan the duration of the image loop. This is beyond the scope of this Standard.

If audio does not start at frame zero, then the appropriate offset may be added by padding the Audio Sample Data with null values to achieve the necessary offset.

C.10.4 Displayed Area Module

This Module describes Attributes required to define a Specified Displayed Area space.

The Specified Displayed Area is that portion of the image displayed on the device.

If Presentation Size Mode (0070,0100) is specified as SCALE TO FIT, then the specified area shall be displayed as large as possible within the available area on the display or window, i.e. magnified or minified if necessary to fit the display or window space available.

If Presentation Size Mode (0070,0100) is specified as TRUE SIZE, then the physical size of the rendered image pixels shall be the same on the screen as specified in Presentation Pixel Spacing (0070,0101).

If Presentation Size Mode (0070,0100) is specified as MAGNIFY, then the factor that shall be used to spatially interpolate image pixels to create pixels on the display is defined.

Note: If this factor is specified as 1.0, then one image pixel will correspond to one displayed pixel, and if the Specified Displayed Area is the entire image, and it fits on the display, then the number of displayed pixels will equal the number of image pixels.

In all modes, the actual area rendered on a display device may be greater than the Specified Display Area, if the ratio of rows and columns of the Specified Display Area differs from the ratio of rows and columns of the display device or window. The Displayed Area relative annotations specified in C.10.5 Graphic Annotation Module are rendered relative to the Specified Displayed Area, not the actual rendered displayed area.

Notes: 1. The content of a display outside the Specified Display Area is not defined. In particular no padding value (such as black) is specified.
2. In the TRUE SIZE and MAGNIFY modes, if the entire Specified Displayed Area is not visible, then display relative graphic annotations may be obscured.

This Module explicitly specifies the aspect ratio to be used to display the image, even if it is 1:1, and it may be different from that specified in the referenced image.

Notes: 1. Depending on the mode, the aspect ratio is either specified using the Presentation Pixel Aspect Ratio (0070,0102), or derived from the Presentation Pixel Spacing (0070,0101).
2. This explicit definition of aspect ratio implies that graphic objects that are specified relative to the Specified Display Area will not change their shape regardless of the size or shape of the presentation device (e.g. whether a landscape or portrait monitor is used).
3. The mechanism of interpolation, if necessary, is not specified.
4. The image may need to be cropped and scroll bars or a panning mechanism provided in order to provide access to sections of the image that do not fit within the available area on the display or window.

Table C.10-4
DISPLAYED AREA MODULE ATTRIBUTES

Attribute Name	Tag	Type	Attribute Description
Displayed Area Selection Sequence	(0070,005A)	1	A sequence of Items each of which describes the displayed area selection for a group of images or frames. Sufficient Items shall be present to describe every image and frame listed in the Presentation State Module. One or more Items shall be present.
>Referenced Image Sequence	(0008,1140)	1C	Sequence of Repeating Items where each Item provides reference to a selected set of Image SOP Class/SOP Instance pairs that are defined in the Presentation State Module. Required if a sequence item is present, and if the displayed area selection in this Item does not apply to all the images listed in the Presentation State Module.
>>Referenced SOP Class UID	(0008,1150)	1C	Uniquely identifies the referenced SOP Class. Required if sequence item is present.
>>Referenced SOP Instance UID	(0008,1155)	1C	Uniquely identifies the referenced SOP Instance. Required if sequence item is present.
>>Referenced Frame Number	(0008,1160)	1C	Identifies the frame numbers within the referenced SOP Instance to which this displayed area selection applies. Required if sequence item is present and the referenced image is a multi-frame image and the displayed area selection does not apply to all frames.
>Displayed Area Top Left Hand Corner	(0070,0052)	1	The top left (after spatial transformation) pixel in the referenced image to be displayed, given as column\row. Column is the horizontal offset (X) and row is the vertical offset (Y) relative to the origin of the pixel data before spatial transformation, which is 1\1.
>Displayed Area Bottom Right Hand Corner	(0070,0053)	1	The bottom right (after spatial transformation) pixel in the referenced image to be displayed, given as column\row. Column is the horizontal offset (X) and row is the vertical offset (Y) relative to the origin of the pixel data before spatial transformation, which is 1\1.

>Presentation Size Mode	(0070,0100)	1	<p>Manner of selection of display size.</p> <p>Enumerated Values:</p> <p style="text-align: center;">SCALE TO FIT TRUE SIZE MAGNIFY</p> <p>See C.10.4 for further explanation.</p>
>Presentation Pixel Spacing	(0070,0101)	1C	<p>Physical distance between the center of each pixel in the referenced image (before spatial transformation), specified by a numeric pair – adjacent row spacing (delimiter) adjacent column spacing in mm.</p> <p>Notes: 1. This value may be different from Pixel Spacing (0028,0030) or Imager Pixel Spacing (0018,1164) specified in the referenced image, which are ignored, since some form of calibration may have been performed (for example by reference to an object of known size in the image).</p> <p>2. If the row and column spacing are different, then the pixel aspect ratio of the image is not 1:1.</p> <p>Required if Presentation Size Mode (0070,0100) is TRUE SIZE, in which case the values will correspond to the physical distance between the center of each pixel on the display device.</p> <p>May be present if Presentation Size Mode (0070,0100) is SCALE TO FIT or MAGNIFY, in which case the values are used to compute the aspect ratio of the image pixels.</p>

<p>>Presentation Pixel Aspect Ratio</p>	<p>(0070,0102)</p>	<p>1C</p>	<p>Ratio of the vertical size and the horizontal size of the pixels in the referenced image, to be used to display the referenced image, specified by a pair of integer values where the first value is the vertical pixel size and the second value is the horizontal pixel size. See C.7.6.3.1.7.</p> <p>Required if Presentation Pixel Spacing (0070,0101) is not present.</p> <p>Notes: 1. This value may be different from the aspect ratio specified by Pixel Aspect Ratio (0028,0034) in the referenced image, or implied by the values of Pixel Spacing (0028,0030) or Imager Pixel Spacing (0018,1164) specified in the referenced image, which are ignored.</p> <p>2. This value must be specified even if the aspect ratio is 1:1.</p>
<p>>Presentation Pixel Magnification Ratio</p>	<p>(0070,0103)</p>	<p>1C</p>	<p>Ratio of displayed pixels to source pixels, specified in one dimension.</p> <p>Required if Presentation Size Mode (0070,0100) is MAGNIFY.</p> <p>Notes: 1. A value of 1.0 would imply that one pixel in the referenced image would be displayed as one pixel on the display (i.e. it would not be interpolated if the aspect ratio of the image pixels is 1:1).</p> <p>2. A value of 2.0 would imply that one pixel in the referenced image would be displayed as 4 pixels on the display (i.e. up-sampled by a factor of 2 in each of the row and column directions).</p> <p>3. A value of 0.5 would imply that 4 pixels in the referenced image would be displayed as 1 pixel on the display (i.e. down-sampled by a factor of 2 in each of the row and column directions).</p> <p>4. If the source pixels have an aspect ratio of other than 1:1, then they are assumed to have been interpolated to a display pixel aspect ratio of 1:1 prior to magnification.</p>

Notes: 1. In scale to fit mode, the Displayed Area Top Left Hand Corner (TLHC) and Bottom Right Hand Corner (BRHC) have the effect of defining how any zoom or magnification and/or pan

has been applied to select a region of an image to be displayed (the Specified Displayed Area), without assuming anything about the size of the actual display.

2. The TLHC and BRHC may be outside the boundaries of the image pixel data (e.g. the TLHC may be 0 or negative, or the BRHC may be greater than Rows or Columns), allowing minification or placement of the image pixel data within a larger Specified Displayed Area. There is no provision to position a zoomed selected sub-area of the image pixel data within a larger Specified Displayed Area.

C.10.5 Graphic Annotation Module

This Module defines Attributes of vector graphics and text annotation that shall be made available by a display device to be applied to an image. The graphics and text are defined in position and size relative to the image pixel coordinates or the Specified Displayed Area space (defined in C.10.4 Displayed Area Module). A Graphic Annotation shall be related to an Image.

Note: This Module uses a Sequence of Items rather than a Repeating Group (such as the Curve Repeating Group) to avoid limiting the maximum number of annotation items that may be present. The use of a Repeating Group would limit the number of items to 16. The use of Repeating Groups is also noted in PS 3.5 to be deprecated.

**Table C.10-5
GRAPHIC ANNOTATION MODULE ATTRIBUTES**

Attribute Name	Tag	Type	Attribute Description
Graphic Annotation Sequence	(0070,0001)	1	A sequence of Items each of which represents a group of annotations composed of graphics or text or both. One or more Items shall be present.
>Referenced Image Sequence	(0008,1140)	1C	Sequence of Repeating Items where each Item provides reference to a selected set of Image SOP Class/SOP Instance pairs that are defined in the Presentation State Module. Required if a sequence item is present, and if graphic annotations in this Item do not apply to all the images listed in the Presentation State Module.
>>Referenced SOP Class UID	(0008,1150)	1C	Uniquely identifies the referenced SOP Class. Required if sequence item is present.
>>Referenced SOP Instance UID	(0008,1155)	1C	Uniquely identifies the referenced SOP Instance. Required if sequence item is present.
>>Referenced Frame Number	(0008,1160)	1C	Identifies the frame numbers within the referenced SOP Instance to which this group of annotations applies. Required if sequence item is present and the referenced image is a multi-frame image and the annotations do not apply to all frames.
>Graphic Layer	(0070,0002)	1	The layer defined in the Graphic Layer Module C.10.7 in which the graphics or text is to be rendered.
>Text Object Sequence	(0070,0008)	1C	Sequence that describes a text annotation. One or more Items may be present. Either one or both of Text Object Sequence (0070,0008) or Graphic Object Sequence (0070,0009) are required if the Sequence Item is present.

>>Bounding Box Annotation Units	(0070,0003)	1C	<p>Units of measure for the axes of the text bounding box.</p> <p>Defines whether or not the annotation is Image or Displayed Area relative. Both dimensions shall have the same units.</p> <p>Enumerated Values:</p> <p>PIXEL = Image relative position specified with sub-pixel resolution such that the origin at the Top Left Hand Corner (TLHC) of the TLHC pixel is 0.0\0.0, the Bottom Right Hand Corner (BRHC) of the TLHC pixel is 1.0\1.0, and the BRHC of the BRHC pixel is Columns\Rows (see figure C.10.5-1). The values must be within the range 0\0 to Columns\Rows.</p> <p>DISPLAY = Fraction of Specified Displayed Area where 0.0\0.0 is the TLHC and 1.0\1.0 is the BRHC. The values must be within the range 0.0 to 1.0.</p> <p>Required if Bounding Box Top Left Hand Corner (0070,0010) or Bounding Box Bottom Right Hand Corner (0070,0011) is present.</p>
>>Anchor Point Annotation Units	(0070,0004)	1C	<p>Units of measure for the axes of the text anchor point annotation.</p> <p>Enumerated Values for Anchor Point Annotation Units (0070,0004) are the same as for Bounding Box Annotation Units (0070,0003).</p> <p>Required if Anchor Point (0070,0014) is present.</p>

>>Unformatted Text Value	(0070,0006)	1	<p>Text data which is unformatted and whose manner of display within the defined bounding box or relative to the specified anchor point is implementation dependent. See C.10.5.1.1.</p> <p>The text value may contain spaces, as well as multiple lines separated by either LF, CR, CR LF or LF CR, but otherwise no format control characters (such as horizontal or vertical tab and form feed) shall be present, even if permitted by the Value Representation of ST.</p> <p>The text shall be interpreted as specified by Specific Character Set (0008,0005) if present in the SOP Common Module.</p> <p>Note: The text may contain single or multi-byte characters and use code extension techniques as described in PS 3.5 if permitted by the values of Specific Character Set (0008,0005).</p>
>>Bounding Box Top Left Hand Corner	(0070,0010)	1C	<p>Location of the Top Left Hand Corner (TLHC) of the bounding box in which Unformatted Text Value (0070,0006) is to be displayed, in Bounding Box Annotation Units (0070,0003), given as column\row . Column is the horizontal offset and row is the vertical offset.</p> <p>Required if Anchor Point (0070,0014) is not present.</p>
>>Bounding Box Bottom Right Hand Corner	(0070,0011)	1C	<p>Location of the Bottom Right Hand Corner (BRHC) of the bounding box in which Unformatted Text Value (0070,0006) is to be displayed, in Bounding Box Annotation Units (0070,0003), given as column\row . Column is the horizontal offset and row is the vertical offset.</p> <p>Required if Anchor Point (0070,0014) is not present.</p>
>>Bounding Box Text Horizontal Justification	(0070,0012)	1C	<p>Location of the text relative to the vertical edges of the bounding box. Enumerated Values:</p> <p>LEFT = closest to left edge RIGHT = closest to right edge CENTER = centered</p> <p>Required if Bounding Box Top Left Hand Corner (0070,0010) is present.</p>

>>Anchor Point	(0070,0014)	1C	<p>Location of a point in the image or Specified Displayed Area to which the Unformatted Text Value (0070,0006) is related, in Anchor Point Annotation Units (0070,0004), given as column\row . Column is the horizontal offset and row is the vertical offset.</p> <p>Required if Bounding Box Top Left Hand Corner (0070,0010) and Bounding Box Bottom Right Hand Corner (0070,0011) are not present.</p> <p>May be present even if a bounding box is specified (i.e. Bounding Box Top Left Hand Corner (0070,0010) and Bounding Box Bottom Right Hand Corner (0070,0011) are present).</p>
>>Anchor Point Visibility	(0070,0015)	1C	<p>Flag to indicate whether or not a visible indication (such as a line or arrow) of the relationship between the text and the anchor point is to be displayed.</p> <p>Enumerated Values: Y = yes N = no</p> <p>Required if Anchor Point (0070,0014) is present.</p>
>Graphic Object Sequence	(0070,0009)	1C	<p>Sequence that describes a graphic annotation. One or more Items may be present.</p> <p>Either one or both of Text Object Sequence (0070,0008) or Graphic Object Sequence (0070,0009) are required if the Sequence Item is present.</p>
>>Graphic Annotation Units	(0070,0005)	1	<p>Units of measure for the axes of the graphic annotation.</p> <p>Enumerated Values for Graphic Annotation Units (0070,0005) are the same as for Bounding Box Annotation Units (0070,0003).</p>
>>Graphic Dimensions	(0070,0020)	1	Enumerated Value: 2
>>Number of Graphic Points	(0070,0021)	1	Number of data points in this graphic.
>> Graphic Data	(0070,0022)	1	<p>Coordinates that specify this graphic annotation .</p> <p>See C.10.5.1.2 for further explanation.</p>

>>Graphic Type	(0070,0023)	1	<p>The shape of graphic that is to be drawn. See C.10.5.1.2.</p> <p>Enumerated Values:</p> <p>POINT POLYLINE INTERPOLATED CIRCLE ELLIPSE</p>
>>Graphic Filled	(0070,0024)	1C	<p>Whether or not the closed graphics element is displayed as filled (in some unspecified manner that shall be distinguishable from an outline) or as an outline. See C.10.5.1.2.</p> <p>Enumerated Values:</p> <p>Y = yes N = no</p> <p>Required if Graphic Data (0070,0022) is "closed", that is Graphic Type (0070,0023) is CIRCLE or ELLIPSE, or Graphic Type (0070,0023) is POLYLINE or INTERPOLATED and the first data point is the same as the last data point.</p>

C.10.5.1 GRAPHIC ANNOTATION ATTRIBUTE DESCRIPTIONS

C.10.5.1.1 Unformatted Text Value

The text shall be displayed if any part of the bounding box or anchor point is within the Specified Display Area.

The text need not be confined to within the bounding box, but shall be rendered in a direction from the Top Left Hand Corner (TLHC) of the bounding box to the Bottom Right Hand Corner (BRHC) of the bounding box, even if these coordinates have been specified in an image relative space and then transformed (rotated, flipped or scaled).

- Notes:
1. An implementation may render text outside the confines of the bounding box if necessary to display all the specified text.
 2. Alternatively, an implementation may choose to render the text in a scrolling box, or a link to another fixed or popup window as appropriate.

Whether the contents of the bounding box completely opacity the underlying image or whether the box is "transparent" is undefined.

- Notes:
1. For example, an implementation may choose an "exclusive or" style opacification to be sure that the text is discernible over light and dark portions of the image.
 2. Commonly, the region of the bounding box around the text will be rendered "transparently", i.e. the image will be visible, though some implementations may choose to opacity the bounding box behind the text to improve its readability.

An alternative to specifying a bounding box, is to specify an Anchor Point (0070,0014), i.e. some point in an image or Specified Displayed Area that is related to the text. The semantics of this relationship, and the manner of positioning or linking the text to this point, are unspecified.

- Notes:
1. For example, a description of a feature may be linked to a point in the image, and when that image is displayed, if it is magnified and panned, the rendered text (and any arrow or line drawn in response to Anchor Point Visibility (0070,0015)) might be repositioned as appropriate so as not to be cropped out of the Specified Displayed Area.
 2. As another example, the text could be rendered in a pop-up window when a hypertext link flagged on the displayed image at the location of the Anchor Point (0070,0014) is selected.
 3. The bounding box and anchor point need not be defined with the same axis units, i.e. one can be image pixel relative, and the other displayed area relative.

The size, font and rotation of the individual rendered text characters are unspecified.

C.10.5.1.2 Graphic Data and Graphic Type

Graphic Data (0070,0022) contains the points in the graphic annotation, each dimension for the first point, followed by dimensions for second point, etc. For a two dimensional curve: X1, Y1, X2, Y2, etc. The first (X) dimension corresponds to the image or Specified Displayed Area column (horizontal offset), and the second (Y) dimension corresponds to the image or Specified Displayed Area row (vertical offset). The Value Representation of all components of the N-tuple shall be the same. The image or Specified Displayed Area relative drawing space is defined in Graphic Annotation Units (0070,0005).

If Graphic Type (0070,0023) is POINT, then two values (one point) shall be specified and the single point specified is to be drawn.

If Graphic Type (0070,0023) is POLYLINE, then the points are to be interpreted as an n-tuple list of end points between which straight lines are to be drawn.

If Graphic Type (0070,0023) is INTERPOLATED, then the points are to be interpreted as an n-tuple list of end points between which some form of implementation dependent curved lines are to be drawn. The rendered line shall pass through all the specified points.

If Graphic Type (0070,0023) is CIRCLE, then exactly two points shall be present; the first point is to be interpreted as the center and the second point as a point on the circumference of a circle, some form of implementation dependent representation of which is to be drawn.

If Graphic Type (0070,0023) is ELLIPSE, then exactly four points shall be present; the first two points are to be interpreted as the endpoints of the major axis and the second two points as the endpoints of the minor axis of an ellipse, some form of implementation dependent representation of which is to be drawn.

The notion of "open" or "closed" has no inherent meaning in the context of an arbitrary graphic, other than in the condition for the presence of Graphic Filled (0070,0024). The graphic has no semantic notion of an associated observation such as a region of interest, except that which the unformatted text in the same Item may describe.

The choice of pixel value used to represent the graphic on a display is defined in the Graphic Layer Module C.10.7.

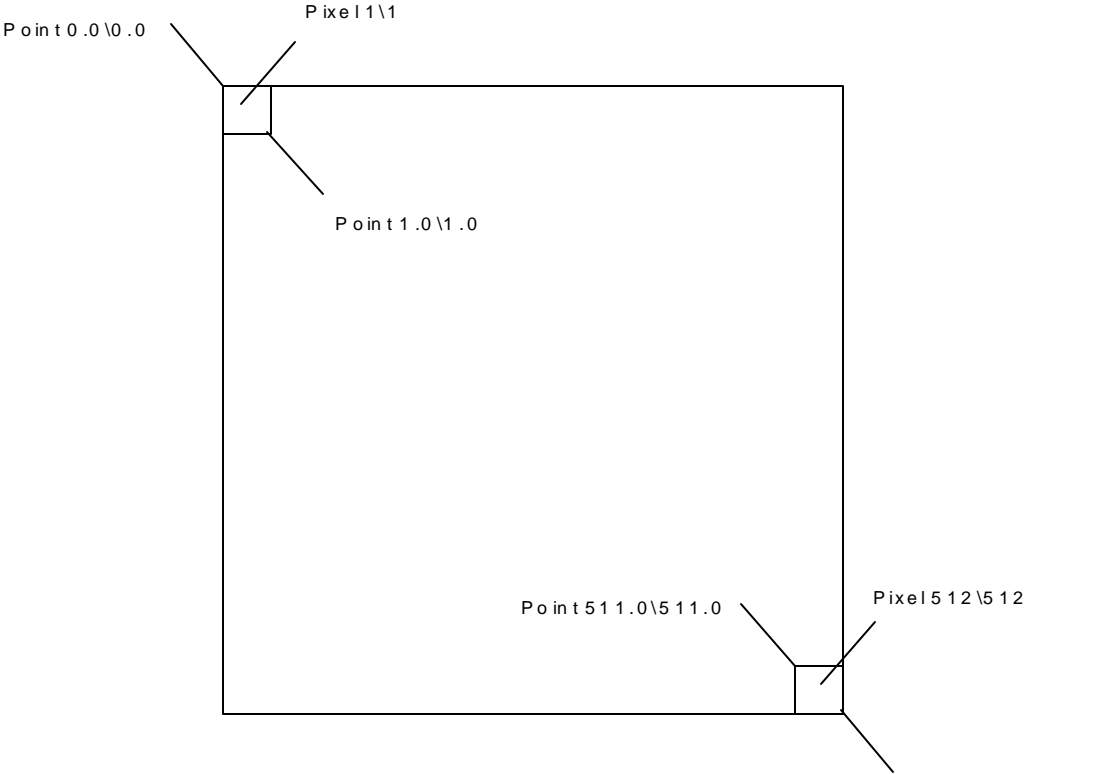

Example for the case where Columns
(0028,0010) = 512 and Rows
(0028,0011) = 512

Point 512.0\512.0

Figure C.10.5-1
Sub-pixel Addressing Units in PIXEL Space

C.10.6 Spatial Transformation Module

This Module defines a manner of rotating an image by increments of ninety degrees and flipping an image.

Table C.10-6
SPATIAL TRANSFORMATION MODULE ATTRIBUTES

Attribute Name	Tag	Type	Attribute Description
Image Rotation	(0070,0042)	1	How far to rotate the image clockwise in degrees, before any Image Horizontal Flip (0070,0041) is applied. Enumerated Values: 0, 90,180,270 Notes: Negative values are not permitted since the Value Representation is unsigned.

Image Horizontal Flip	(0070,0041)	1	Whether or not to flip the image horizontally after any Image Rotation has been applied such that the left side of the image becomes the right side. Enumerated Values: Y = yes, N = no Note: No vertical flip is specified since the same result can be achieved by a combination of a 180 degree rotation and a horizontal flip.
-----------------------	-------------	---	--

Note: Given the definition of the Grayscale Transformation Sequence in PS 3.4, it is apparent that the rotation, flipping and magnification will be applied AFTER the application of any bit-mapped overlays or graphic annotations that are specified in the image pixel spaces, but BEFORE the application of graphic annotations that apply in the Specified Displayed Area relative space.

C.10.7 Graphic Layer Module

This Module defines the characteristics of the layers in which curves, overlays, graphic and text may be rendered.

Layers group together graphics which are related. It is recommended that a layer be displayed such that it may be distinguished from other layers that have a different value for Graphic Layer Order (0070,0062).

Note: The transparency, opacity, and any other interaction (such as exclusive or) with underlying layers or image data are not specified and are at the discretion of the implementation.

Table C.10-7
GRAPHIC LAYER MODULE ATTRIBUTES

Attribute Name	Tag	Type	Attribute Description
Graphic Layer Sequence	(0070,0060)	1	A sequence of Items each of which represents a single layer in which overlays, curves, graphics or text may be rendered. An Item is required for each layer referenced from the Graphic Annotation Module or the Overlay/Curve Activation Module.
>Graphic Layer	(0070,0002)	1	A string which identifies the layer. Note: This identifier may be used by other Attributes within the same presentation state instance to reference this layer. There is no requirement for the same identifiers to be used in different presentation states, and there is no mechanism for referencing layers in other presentation states. That is, a UID is not required.
>Graphic Layer Order	(0070,0062)	1	An integer indicating the order in which it is recommended that the layer be rendered, if the display is capable of distinguishing. Lower numbered layers are to be rendered first.
>Graphic Layer Recommended Display Grayscale Value	(0070,0066)	3	A default single gray unsigned value in which it is recommended that the layer be rendered on a monochrome display. The units are specified in P-Values from a minimum of 0000H (black)_up to a maximum of FFFFH (white). Note: The maximum P-Value for this Attribute may be different from the maximum P-Value from the output of the Presentation LUT, which may be less than 16 bits in depth.
>Graphic Layer Recommended Display RGB Value	(0070,0067)	3	A triplet of unsigned RGB values in which it is recommended that the layer be rendered on a color display. The minimum intensity displayable is specified as 0000H\0000H\0000H (black) and the maximum intensity displayable as FFFFH\FFFFH\FFFFH (white).
>Graphic Layer Description	(0070,0068)	3	A free text description of the contents of this layer.

C.10.8 Waveform Identification Module

The table in this section contains Attributes that identify a Waveform as a separate information entity.

Table C.10-8
Waveform Identification Module Attributes

Attribute Name	Tag	Type	Attribute Description
Instance Number	(0020,0013)	1	A number that identifies this Waveform.
Content Date	(0008,0023)	1	The date the Waveform data was created.
Content Time	(0008,0033)	1	The time the Waveform data was created.
Acquisition Datetime	(0008,002A)	1	The date and time that the acquisition of data that resulted in this waveform started; the reference timestamp for the Multiplex Group Time Offset (0018,1068) for a waveform multiplex group Note: The synchronization of this time with an external clock is specified in the Synchronization Module in Acquisition Time Synchronized (0018,1800).
Referenced Instance Sequence	(0008,114A)	3	A sequence which provides reference to a set of SOP Class/Instance pairs significantly related to this Waveform. One or more Items may be included in this sequence.
>Referenced SOP Class UID	(0008,1150)	1C	Uniquely identifies the referenced SOP Class. Required if a Sequence Item is present.
>Referenced SOP Instance UID	(0008,1155)	1C	Uniquely identifies the referenced SOP Instance. Required if a Sequence Item is present.

Note: The Acquisition Datetime (0008,002A) is the time of the original waveform data capture. Derived waveforms which are processed (e.g., averaged or filtered) and encoded subsequent to the waveform Acquisition Datetime have a Content Date (0008,0023) and Content Time (0008,0033) representing the time of the processing. In all cases the actual date and time of creation of the SOP Instance for transmission or storage may be recorded in the Instance Creation Date (0008,0012) and Instance Creation Time (0008,0013) (see Section C.12.2).

C.10.9 Waveform Module

The table in this section contains Attributes that describe a time-based waveform. A waveform consists of one or more multiplex groups, each encoded into an Item in the Waveform Sequence. All channels within a multiplex group are synchronously digitized at a common sampling frequency.

Table C.10-9
Waveform Module Attributes

Attribute Name	Tag	Type	Attribute Description
Waveform Sequence	(5400,0100)	1	Sequence of one or more Items, each representing one waveform multiplex group. Ordering of Items in this Sequence is significant for external reference to specific multiplex groups.
> Multiplex Group Time Offset	(0018,1068)	1C	Offset time in milliseconds from a reference time (see C.10.9.1.1). Required if Acquisition Time Synchronized (0018,1800) value is Y; may be present otherwise.

> Trigger Time Offset	(0018,1069)	1C	Offset time in milliseconds from a synchronization trigger to the first sample of a waveform multiplex group. May be positive or negative. Required if waveform acquisition is synchronized to a trigger.
> Trigger Sample Position	(0018,106E)	3	Sample number whose time corresponds to a synchronization trigger (see C.10.9.1.2).
> Waveform Originality	(003A,0004)	1	See C.10.9.1.3. Enumerated values: ORIGINAL DERIVED
> Number of Waveform Channels	(003A,0005)	1	Number of channels for this multiplex group.
> Number of Waveform Samples	(003A,0010)	1	Number of samples per channel in this multiplex group.
> Sampling Frequency	(003A,001A)	1	Frequency in Hz
> Multiplex Group Label	(003A,0020)	3	Label for multiplex group
> Channel Definition Sequence	(003A,0200)	1	Sequence of one or more Items, with one Item per channel (see C.10.9.1.4). Ordering of Items in this Sequence is significant for reference to specific channels.
>> Waveform Channel Number	(003A,0202)	3	Equipment physical channel number used for acquisition.
>> Channel Label	(003A,0203)	3	Text label for channel which may be used for display purposes
>> Channel Status	(003A,0205)	3	One or more values for the status of this channel within this SOP Instance. Defined terms: OK TEST DATA DISCONNECTED QUESTIONABLE INVALID UNCALIBRATED UNZEROED Precise location of a change in status may be noted in an Annotation.
>> Channel Source Sequence	(003A,0208)	1	A coded descriptor of the waveform channel source (metric, anatomical position, function, and technique). Only a single Item shall be permitted in this sequence. (See C.10.9.1.4.1)
>>> Include 'Code Sequence Macro' Table 8.8-1.			Baseline Context ID determined by IOD specialization
>> Channel Source Modifiers Sequence	(003A,0209)	1C	Sequence of one or more Items which further qualify the Waveform Source. Required if Channel Source Sequence (003A,0208) does not fully specify the semantics of the source. Ordering of Items in this Sequence may be semantically significant.
>>> Include 'Code Sequence Macro' Table 8.8-1.			Baseline Context ID determined by IOD specialization

>> Source Waveform Sequence	(003A,020A)	3	A sequence which provides reference to a DICOM waveform from which this channel was derived. One or more Items may be included in this Sequence.
>>>Referenced SOP Class UID	(0008,1150)	1C	Identifies the referenced SOP Class. Required if a Sequence Item is present.
>>>Referenced SOP Instance UID	(0008,1155)	1C	Identifies the referenced SOP Instance. Required if a Sequence Item is present.
>>> Referenced Waveform Channels	(0040,A0B0)	1C	Identifies the waveform multiplex group and channel within the referenced SOP Instance. Pair of values (M,C). Required if a Sequence Item is present.
>> Channel Derivation Description	(003A,020C)	3	Additional description of waveform channel derivation
>> Channel Sensitivity	(003A,0210)	1C	Nominal numeric value of unit quantity of sample. Required if samples represent defined (not arbitrary) units.
>> Channel Sensitivity Units Sequence	(003A,0211)	1C	A coded descriptor of the Units of measure for the Channel Sensitivity. Only a single Item shall be permitted in this sequence. (see C.10.9.1.4.2) Required if Channel Sensitivity (003A,0210) is present.
>>> Include 'Code Sequence Macro' Table 8.8-1.			Defined Context ID = 3082
>> Channel Sensitivity Correction Factor	(003A,0212)	1C	Multiplier to be applied to encoded sample values to match units specified in Channel Sensitivity (003A,0210) (e.g., based on calibration data) (see C.10.9.1.4.2) Required if Channel Sensitivity (003A,0210) is present.
>> Channel Baseline	(003A,0213)	1C	Offset of encoded sample value 0 from actual 0 using the units defined in the Channel Sensitivity Units Sequence (003A,0211). Required if Channel Sensitivity (003A,0210) is present.
>> Channel Time Skew	(003A,0214)	1C	Offset of first sample of channel from waveform multiplex group start time, in seconds (see C.10.9.1.4.3) Required if Channel Sample Skew is not present.
>> Channel Sample Skew	(003A,0215)	1C	Offset of first sample of channel from waveform multiplex group start time, in samples (see C.10.9.1.4.3) Required if Channel Time Skew is not present.
>> Channel Offset	(003A,0218)	3	Additional offset of first sample of channel to be used in aligning multiple channels for presentation or analysis, in seconds (see C.10.9.1.4.3)
>> Waveform Bits Stored	(003A,021A)	1	Number of significant bits within the waveform samples (see C.10.9.1.4.4)
>> Filter Low Frequency	(003A,0220)	3	Nominal 3dB point of lower frequency of pass band; in Hz
>> Filter High Frequency	(003A,0221)	3	Nominal 3dB point of upper frequency of pass band; in Hz
>> Notch Filter Frequency	(003A,0222)	3	Center frequency of notch filter(s); in Hz
>> Notch Filter Bandwidth	(003A,0223)	3	Nominal 3dB bandwidth of notch filter(s); in Hz

>> Channel Minimum Value	(5400,0110)	3	Minimum valid sample value as limited by the acquisition equipment (see C.10.9.1.4.5)
>> Channel Maximum Value	(5400,0112)	3	Maximum valid sample value as limited by the acquisition equipment (see C.10.9.1.4.5)
> Waveform Bits Allocated	(5400,1004)	1	Size of each waveform data sample within the Waveform Data; see section C.10.9.1.5
> Waveform Sample Interpretation	(5400,1006)	1	Data representation of the waveform data points. See C.10.9.1.5.
> Waveform Padding Value	(5400,100A)	1C	Value of waveform samples inserted in channels when input is absent or invalid. Required if acquisition equipment inserts padding. See C.10.9.1.6.
> Waveform Data	(5400,1010)	1	Encoded data samples - channel multiplexed See section C.10.9.1.7

C.10.9.1 Waveform Attribute Descriptions

C.10.9.1.1 Multiplex Group Time Offset

Multiplex Group Time Offset (0018,1068) specifies the offset time in milliseconds from a reference time to the first sample of the multiplex group. The reference time is the Acquisition Datetime (0008,002A), if present in the SOP Instance.

In all other cases, the offset is from an arbitrary reference time that is the same for all Multiplex Groups in the SOP Instance; i.e., the Multiplex Group Time Offset allows only relative time synchronization between Multiplex Groups in the SOP Instance. The arbitrary reference time may nominally be assumed to be the Content Time (0008,0033).

C.10.9.1.2 Trigger Sample Position

The Trigger Sample Position (0018,106E) specifies the sample which was digitized at the same time as a synchronization trigger. Sample positions are enumerated by channel, with the first sample enumerated 1. This provides a single trigger sample location for all channels of the multiplex group. Although channels may not have been sampled synchronously (as specified by Channel Time Skew or Channel Sample Skew), for the purpose of determining the location of the trigger with an integer value position, all channels are considered to be synchronous.

C.10.9.1.3 Waveform Originality

Waveform Originality (003A,0004) shall have the value ORIGINAL if the Waveform Data samples are the original or source data, and shall have the value DERIVED if the Waveform Data samples have been derived in some manner from the sample data of other waveforms.

- Notes :
1. The Waveform Originality (003A,0004) attribute is comparable to the Image Type (0008,0008) attribute value 1 (see C.7.6.1.1.2). Within a single Multiplex Group, all channels shall have the same Originality value.
 2. Waveform data which has been transcoded from a non-DICOM format may have Waveform Originality value ORIGINAL if the samples are unchanged from the originally acquired waveform samples.

C.10.9.1.4 Channel Definition Sequence

C.10.9.1.4.1 Channel Source and Modifiers

Channel Source Sequence (003A,0208) identifies the metric (quality being measured, e.g., voltage or pressure), the anatomical position of the sensor or probe, the function of the channel (e.g.,

measurement or stimulus), and any particulars of technique which affect those parameters (e.g., pull-back across multiple anatomic sites, or differential input from two distinct sites). If the full semantics of the source is not carried in a single coded entry (e.g., if it specifies the location but not the metric), additional qualifiers are identified in Channel Source Modifiers Sequence (003A,0209) coded entries.

When a single sensor channel is used to collect a waveform from two (or more) anatomic sites, e.g., in hemodynamic pull-back procedures, multiple Channel Source Modifier items will identify the sequence of sites, if not encoded in the semantics of the Channel Source Coded Entry. Transition times from one site to another may be indicated with an Annotation, or pull-back rate may be indicated with an Acquisition Context Sequence Item (see Section C.7.6.14).

The Baseline (default) Context IDs are defined by IOD in accordance with Section A.34. Restrictions in the IOD may also determine the pattern of specification of the waveform source, i.e., which item is to be encoded in the Channel Source sequence, and the order in which Channel Source Modifier items are to be encoded. Unless otherwise specified, pattern of specification of the waveform source shall be:

1. If the function of the channel is not measurement, the function (and optionally additional parameters of the channel source) shall be encoded in the Channel Source item.
2. If the function of the channel is measurement of a waveform originating in the patient (the implicit default function), the metric (and optionally additional parameters of the channel source) shall be encoded in the Channel Source item.
3. If not encoded in the Channel Source item, and a particular technique needs to be encoded, that technique shall be encoded in the first Channel Source Modifier item.

Note: For example, an intracardiac measurement of a pressure waveform across the mitral valve by means of a catheter pullback may be encoded in one of the following three ways (using pseudo-coded terminology), depending on the availability of coded terms with sufficient expressive power:

Channel Source	Channel Source Modifiers
X-2311 "pressure measurement"	T-7663 "pullback" C-2001 "mitral valve"
X-2123 "pressure measurement, pullback"	C-2001 "mitral valve"
X-1234 "pressure measurement, mitral valve, pullback"	(none required)

C.10.9.1.4.2 Channel Sensitivity and Channel Sensitivity Units

Channel Sensitivity is the nominal value of one unit (i.e., the least significant bit) of each waveform sample in the Waveform Data attribute (5400,1010). It includes both the amplifier gain and the analog-digital converter resolution. It does not relate the vertical scaling of a waveform on a particular display.

Note: The Defined (default) Context Group for Channel Sensitivity Units Sequence is CID 3082 Waveform Units of Measurement, which includes all the commonly used measurement values. Units of measurement not included in the default list can be specified using the more general CID 82 Units of Measurement, or a local Coding Scheme. The Defined Context ID may be replaced in a specialization of the IOD.

Channel Sensitivity Correction Factor (003A,0212) is the ratio of the actual (calibrated) value to the nominal Channel Sensitivity specified in Data Element (003A,0210). Thus a waveform sample value multiplied by the Channel Sensitivity value provides the nominal measured value in Channel

Sensitivity Units, and that nominal value multiplied by the Channel Sensitivity Correction Factor provides the calibrated measured value.

C.10.9.1.4.3 Channel Skew and Channel Offset

Skew is also known as a sub-sample time delay, typically caused by using a multiplexed analog to digital converter which switches from channel to channel. For analysis it may be important to know if the analog channels were all latched simultaneously or sequentially and then digitized. Skew may be represented as time offset in seconds, or a fractional number of samples.

Separate and additional to skew is an offset time adjustment (sometimes called latency) by which one waveform channel is displaced significantly relative to others before sampling.

Note: As an example, a hemodynamic pressure is measured at the external end of a catheter, and thus its measurement is delayed by the time for the pressure wave to propagate down the catheter. With a dual catheter measurement, two signals may be acquired at the same time, but one arrives by a longer distance (e.g., a pulmonary capillary wedge pressure, compared to a left ventricular pressure). To obtain an accurate comparison of the waveforms (e.g., the gradient across the mitral valve), one waveform has to be offset (perhaps as much as 30 ms) to synchronize them.

C.10.9.1.4.4 Waveform Bits Stored

Waveform Bits Stored (003A,021A) specifies the number of significant bits within the Waveform Bits Allocated of each sample, for signed or unsigned integers.

If Waveform Sample Value Representation is MB or AB, Waveform Bits Stored shall be 8.

C.10.9.1.4.5 Channel Minimum and Maximum Value

Channel Minimum and Maximum Value attributes (5400,0110) and (5400,0112) may be used to send the analog-to-digital converter limits (i.e., the clipping levels).

Note: These values do not represent the maximum and minimum values in the data set, but rather the valid range of values.

C.10.9.1.5 Waveform Bits Allocated and Waveform Sample Interpretation

Waveform Bits Allocated (5400,1004) specifies the number of bits allocated for each sample, and Waveform Sample Interpretation (5400,1006) specifies the data representation of each waveform sample. Waveform Bits Allocated shall be a multiple of 8. These data elements are related, and their defined terms are specified in Table C.10-5.

Table C.10-10
Waveform Bits Allocated and Waveform Sample Interpretation

Waveform Bits Allocated - Defined Terms	Waveform Sample Interpretation - Defined Terms	Waveform Sample Interpretation Meaning
8	SB	signed 8 bit linear
	UB	unsigned 8 bit linear
	MB	8 bit mu-law (in accordance with ITU-T Recommendation G.711)
	AB	8 bit A-law (in accordance with ITU-T Recommendation G.711)
16	SS	signed 16 bit linear
	US	unsigned 16 bit linear

- Notes:
1. The set of valid values from within this table may be constrained by definition of the IOD (see Section A.34).
 2. mu-law and A-law encoding is without the alternate bit inversion used for PCM transmission through the telephone network.

This representation also applies to the Channel Minimum and Maximum Data Values, and Waveform Padding Value.

C.10.9.1.6 Waveform Padding Value

Equipment which produces digitized waveform curves may encode a specific value when the source is disconnected or otherwise invalid. This value is encoded like the Waveform Data attribute with one sample only.

The Waveform Padding Value need not be within the range specified by the Channel Minimum and Maximum Data Values.

C.10.9.1.7 Waveform Data

Each sample shall be encoded using the defined Waveform Sample Interpretation (5400,1006), using the defined number of Waveform Bits Stored (003A,021A) right justified in the sample. If the number of Waveform Bits Stored is less than the number of bits in Waveform Bits Allocated, the sign bit shall be extended to the highest order bit of the data sample.

Data values are encoded interleaved, incrementing by channel and then by sample (i.e., C1S1, C2S1,C3S1, ... CnS1, C1S2, C2S2, C3S2, ... CnSm), with no padding or explicit delimitation between successive samples. Cx denotes the channel defined in the Channel Definition Sequence Item in item number x.

- Notes:
1. With 8-bit Waveform Data, there may be an odd number of channels and an odd number of samples; see PS3.5 for rules on encoding.
 2. The sign bit extension rule differs from the rules for pixel data, which do not require sign extension.

C.10.10 Waveform Annotation Module

The table in this section contains Attributes that identify annotations to the waveform of the current SOP Instance. Each annotation conceptually forms the equivalent of a overlay on a presentation display of the annotated entity. Annotations may represent a measurement or categorization based on the waveform data, identification of regions of interest or particular features of the waveform, or events during the data collection which may affect diagnostic interpretation (e.g., the time at which the subject coughed).

Each Annotation Item shall have the following components:

1. An annotation Text, Coded Name (only), Coded Name/Coded Value pair, or Coded Name/Numeric Measurement pair (mutually exclusive)
2. Temporal coordinates in the Waveform to which the annotation applies

Table C.10-11 – Waveform Annotation Module Attributes

Attribute Name	Tag	Type	Attribute Description
Waveform Annotation Sequence	(0040,B020)	1	Sequence of Annotation Items; one or more items shall be present

> Unformatted Text Value	(0070,0006)	1C	Text Observation Value (annotation). Mutually exclusive with Concept Name Code Sequence (0040,A043)
> Concept Name Code Sequence	(0040,A043)	1C	Code representing the fully specified name of the NUMERIC measurement or CODED concept. This sequence shall contain exactly one item. Mutually exclusive with Text Value (0070,0006).
>>Include 'Code Sequence Macro' Table 8.8-1			Baseline Context ID may be defined in IOD definition.
>> Modifier Code Sequence	(0040,A195)	1C	A sequence of items modifying or specializing the Concept Name. Any number of items may be present. Required if Concept Name Code Sequence (0040,A043) is sent and the value does not fully describe the semantics of the measurement or concept.
>>>Include 'Code Sequence Macro' Table 8.8-1			Baseline Context ID may be defined in IOD definition.
> Concept Code Sequence	(0040,A168)	3	A sequence that conveys the categorical coded nominal value.
>>Include 'Code Sequence Macro' Table 8.8-1			Baseline Context ID may be defined in IOD definition.
>> Modifier Code Sequence	(0040,A195)	1C	A sequence of items modifying or specializing the Concept. Any number of items may be present. Required if Concept Code Sequence (0040,A168) is sent and the value does not fully describe the semantics of the concept value.
>>>Include 'Code Sequence Macro' Table 8.8-1			Baseline Context ID may be defined in IOD definition.
> Numeric Value	(0040,A30A)	3	Numeric measurement value or values.
> Measurement Units Code Sequence	(0040,08EA)	3	Units of measurement. Coded entry sequence with one item only.
>> Include 'Code Sequence Macro' Table 8.8-1			Baseline Context ID 82
> Referenced Waveform Channels	(0040,A0B0)	1	List of channels in waveform to which annotation applies. See C.10.10.1.1
> Temporal Range Type	(0040,A130)	1C	See C.10.10.1.2 for Enumerated Values. Required if Annotation does not apply to entire Referenced Waveform Channels; shall not be present if Annotation applies to entire temporal extent of referenced channels.

> Referenced Sample Positions	(0040,A132)	1C	List of samples within a multiplex group specifying temporal points for annotation. Position of first sample is 1. Required if Temporal Range Type (0040,A130) is present, and if Referenced Time Offsets (0040,A138) and Referenced Datetime (0040,A13A) are not present. See C.10.10.1.3
> Referenced Time Offsets	(0040,A138)	1C	Specifies temporal points for annotation by number of seconds after start of data. Required if Temporal Range Type (0040,A130) is present, and if Referenced Sample Positions (0040,A132) and Referenced Datetime (0040,A13A) are not present.
> Referenced Datetime	(0040,A13A)	1C	Specifies temporal points for annotation by absolute time. Required if Temporal Range Type (0040,A130) is present, and if Referenced Sample Positions (0040,A132) and Referenced Time Offsets (0040,A138) are not present.
> Annotation Group Number	(0040,A180)	3	Number identifying associated annotations (see C.10.10.1.4).

C.10.10.1 Annotation Attribute Descriptions

C.10.10.1.1 Referenced Channels

Referenced Waveform Channels (0040,A0B0) is a multi-value attribute which lists the channels to which an annotation of a waveform applies. Each channel is specified as a pair of values (M,C), where the first value is the ordinal of the sequence item of the Waveform Sequence (5400,0100) attribute (i.e., the Multiplex Group Number), and the second value is the ordinal of the sequence item of the Channel Definition Sequence (003A,0200) attribute (i.e., the Waveform Channel Number) within the multiplex group.

If the specified channel number is 0, the annotation applies to all channels in the multiplex group.

Note: As an example, an annotation which applies to the entire first multiplex group and channels 2 and 3 of the third multiplex group would have Referenced Channels value 0001 0000 0003 0002 0003 0003.

C.10.10.1.2 Temporal Range Type

The Temporal Range Type attribute (0040,A130) defines the type of temporal extent of the annotated region of interest. A temporal point (or instant of time) may be defined by a waveform sample offset (for a single waveform multiplex group only), time offset, or absolute time.

The following terms are Enumerated Values for Temporal Range Type:

POINT = a single temporal point

MULTIPOINT = multiple temporal points

SEGMENT = a range between two temporal points

MULTISEGMENT = multiple segments, each denoted by two temporal points

BEGIN = a range beginning at one temporal point, and extending beyond the end of the acquired data

END = a range beginning before the start of the acquired data, and extending to (and including) the identified temporal point

C.10.10.1.3 Referenced Sample Positions

Referenced Sample Positions (0040,A132) may be used only if Referenced Waveform Channels (0040,A0B0) refers to channels within a single multiplex group. The sample position is by channel, and applies to all channels specified in Referenced Channels (0040,A0B0).

C.10.10.1.4 Annotation Group Number

The Annotation Group Number (0040,A180) allows the logical association of multiple annotations within the current SOP Instance. Such linked annotations share an Annotation Group Number, but each annotation is semantically separable. The nature of the association is not defined. The number is not semantically significant.

Note: For instance, the R-wave in several waveform channels may be annotated, and all occurrences of the same R-wave could be linked in an annotation group.

C.11 LOOK UP TABLES

C.11.1 Modality LUT module

Table C.11-1 specifies the Attributes that describe the Modality LUT.

Either a Modality LUT Sequence containing a single Item or Rescale Slope and Intercept values shall be present but not both.

Note: This requirement for only a single transformation makes it possible to unambiguously define the input of succeeding stages of the grayscale pipeline such as the VOI LUT.

**Table C.11-1
MODALITY LUT MODULE ATTRIBUTES**

Attribute Name	Tag	Type	Attribute Description
Modality LUT Sequence	(0028,3000)	1C	Defines a sequence of Modality LUTs. Only one Item may be present. Shall not be present if Rescale Intercept (0028,1052) is present.
>LUT Descriptor	(0028,3002)	1C	Specifies the format of the LUT Data in this Sequence. See C.11.1.1 for further explanation. Required if the Modality LUT Sequence (0028,3000) is sent.
>LUT Explanation	(0028,3003)	3	Free form text explanation of the meaning of the LUT.
>Modality LUT Type	(0028,3004)	1C	Specifies the output values of this Modality LUT. See C.11.1.1.2 for further explanation. Required if the Modality LUT Sequence (0028,3000) is sent.
>LUT Data	(0028,3006)	1C	LUT Data in this Sequence. Required if the Modality LUT Sequence (0028,3000) is sent.
Rescale Intercept	(0028,1052)	1C	The value b in relationship between stored values (SV) and the output units specified in Rescale Type (0028,1054). Output units = $m \cdot SV + b$. Required if Modality LUT Sequence (0028,3000) is not present. Shall not be present otherwise.
Rescale Slope	(0028,1053)	1C	m in the equation specified by Rescale Intercept (0028,1052). Required if Rescale Intercept is present.

Rescale Type	(0028,1054)	1C	Specifies the output units of Rescale Slope (0028,1053) and Rescale Intercept (0028,1052). See C.11.1.1.2 for further explanation. Required if Rescale Intercept is present.
--------------	-------------	----	--

C.11.1.1 LUT Attribute Descriptions

C.11.1.1.1 LUT descriptor

The three values of the LUT Descriptor (0028,3002) describe the format of the LUT Data in the corresponding Data Element (0028,3006).

The first value is the number of entries in the lookup table. When the number of table entries is equal to 2^{16} then this value shall be 0.

The second value is the first stored pixel value mapped. The Value Representation of the second value (US or SS) is specified by Pixel Representation (0028,0103). This stored pixel value is mapped to the first entry in the LUT. All stored pixel values less than the first value mapped are also mapped to the first entry in the LUT Data. A stored pixel value one greater than the first value mapped is mapped to the second entry in the LUT Data. Subsequent stored pixel values are mapped to the subsequent entries in the LUT Data up to a stored pixel value equal to number of entries + first value mapped - 1 which is mapped to the last entry in the LUT Data. Stored pixel values greater than or equal to number of entries + first value mapped are also mapped to the last entry in the LUT Data.

The third value specifies the number of bits for each entry in the LUT Data. It shall take the value 8 or 16. The LUT Data shall be stored in a format equivalent to 8 or 16 bits allocated where the high bit is equal to bits allocated - 1.

The third value also conveys the range of LUT entry values. It shall take the value 8 or 16, corresponding with the LUT entry value range of 256 or 65536.

Note: Since the LUT Descriptor (0028,3002) Attribute is multi-valued, in an Explicit VR Transfer Syntax, only one value representation (US or SS) may be specified, even though the first and third values are always by definition interpreted as unsigned. The explicit VR actually used is dictated by the VR needed to represent the second value, which will be consistent with Pixel Representation (0028,0103).

The LUT Data contains the LUT entry values.

The output range of the Modality LUT Module depends on whether or not Rescale Slope and Rescale Intercept or the Modality LUT Sequence are used.

In the case where Rescale Slope and Rescale Intercept are used, the output ranges from (minimum pixel value*Rescale Slope+Rescale Intercept) to (maximum pixel value*Rescale Slope+Rescale Intercept), where the minimum and maximum pixel values are determined by Bits Stored and Pixel Representation.

Note: This range may be signed even if Pixel Representation is unsigned.

In the case where the Modality LUT Sequence is used, the output range is from 0 to 2^n-1 where n is the third value of LUT Descriptor. This range is always unsigned.

C.11.1.1.2 Modality LUT and Rescale Type

Specifies the units of the output of the Modality LUT or rescale operation.

Defined Terms:

OD = The number in the LUT represents thousands of optical density. That is, a value of 2140 represents an optical density of 2.140.

HU = Hounsfield Units (CT)

US = Unspecified

Other values are permitted, but are not defined by the DICOM Standard.

C.11.2 VOI LUT module

Table C.11-2 specifies the Attributes that describe the VOI LUT.

**Table C.11-2
VOI LUT MODULE ATTRIBUTES**

Attribute Name	Tag	Type	Attribute Description
VOI LUT Sequence	(0028,3010)	3	Defines a sequence of VOI LUTs.
>LUT Descriptor	(0028,3002)	1C	Specifies the format of the LUT Data in this Sequence. See C.11.2.1.1 for further explanation. Required if the VOI LUT Sequence (0028,3010) is sent.
>LUT Explanation	(0028,3003)	3	Free form text explanation of the meaning of the LUT.
>LUT Data	(0028,3006)	1C	LUT Data in this Sequence. Required if the VOI LUT Sequence (0028,3010) is sent.
Window Center	(0028,1050)	3	Window Center for display. See C.11.2.1.2 for further explanation.
Window Width	(0028,1051)	1C	Window Width for display. See C.11.2.1.2 for further explanation. Required if Window Center (0028,1050) is sent.
Window Center & Width Explanation	(0028,1055)	3	Free form explanation of the meaning of the Window Center and Width. Multiple values correspond to multiple Window Center and Width values.

C.11.2.1 LUT Attribute Descriptions

C.11.2.1.1 LUT Descriptor

The three values of the LUT Descriptor (0028,3002) describe the format of the LUT Data in the corresponding Data Element (0028,3006).

The first value is the number of entries in the lookup table. When the number of table entries is equal to 2^{16} then this value shall be 0.

The second value is the first input value mapped. The Value Representation of the second value (US or SS) depends on the source of the input to the VOI LUT, and shall be:

- the same as specified by Pixel Representation (0028,0103), if there is no Modality LUT or Rescale Slope and Intercept specified;
- SS if the possible output range after application of the Rescale Slope and Intercept may be signed;

Note: This is always the case for the CT Image IOD in which the Rescale Type is specified to be Hounsfield Units, which are always signed.

- US otherwise.

This input value is mapped to the first entry in the LUT. All input values less than the first value mapped are also mapped to the first entry in the LUT Data. An input value one greater than the first value mapped is mapped to the second entry in the LUT Data. Subsequent input values are mapped to the subsequent entries in the LUT Data up to an input value equal to number of entries + first value mapped - 1 which is mapped to the last entry in the LUT Data. Input values greater than or equal to number of entries + first value mapped are also mapped to the last entry in the LUT Data.

The third value specifies the number of bits for each entry in the LUT Data. If the VOI LUT is included in an Image IOD, the third value of LUT Descriptor (0028,3002) shall be 8 or 16 bits, unless otherwise specialized. If the VOI LUT is included in a Presentation State IOD, the third value of LUT Descriptor (0028,3002) shall be between 8 and 16 inclusive. The LUT Data shall be stored in a format equivalent to 8 or 16 bits allocated where the high bit is equal to bits stored - 1, where bits stored is the third value.

Note: Since the LUT Descriptor (0028,3002) Attribute is multi-valued, in an Explicit VR Transfer Syntax, only one value representation (US or SS) may be specified, even though the first and third values are always by definition interpreted as unsigned. The explicit VR actually used is dictated by the VR needed to represent the second value.

The LUT Data contains the LUT entry values.

The output range is from 0 to 2^n-1 where n is the third value of LUT Descriptor. This range is always unsigned.

C.11.2.1.2 Window center and window width

Window Center (0028,1050) and Window Width (0028,1051) specify a linear conversion from stored pixel values (after any Modality LUT or Rescale Slope and Intercept specified in the IOD have been applied) to values to be displayed. Window Center contains the input value that is the center of the window. Window Width contains the width of the window.

Note: The terms "window center" and "window width" are not consistently used in practice, nor were they defined in previous versions of the standard. The definitions here are presented for the purpose of defining consistent meanings for identity and threshold transformations while preserving the common practice of using integral values for center and width.

Window Width (0028,1051) shall always be greater than or equal to 1.

When Window Width (0028,1051) is greater than 1, these Attributes select the range of input values that are to be mapped to the full range of the displayed output.

When Window Width (0028,1051) is equal to 1, they specify a threshold below which input values will be displayed as the minimum output value.

Note: Whether the minimum output value is rendered as black or white may depend on the value of Photometric Interpretation (0028,0004) or the presence of a Presentation LUT Module.

These Attributes are applied according to the following pseudo-code, where x is the input value, y is an output value with a range from y_{\min} to y_{\max} , c is Window Center (0028,1050) and w is Window Width (0028,1051):

```
if      (x <= c - 0.5 - (w-1)/2), then y = ymin
else if (x > c - 0.5 + (w-1)/2), then y = ymax
else   y = ((x - (c - 0.5)) / (w-1) + 0.5) * (ymax - ymin) + ymin
```

Notes: 1. For the purpose of this definition, a floating point calculation without integer truncation is assumed, though the manner of implementation may vary as long as the result is the same.
2. The pseudo-code function computes a continuous value over the output range without any discontinuity at the boundaries. The value of 0 for w is expressly forbidden, and the value of 1 for w does not cause division by zero, since the continuous segment of the function will never be reached for that case.

3. For example, for an output range 0 to 255:

$c=2048, w=4096$ becomes:

```
if (x <= 0) then y = 0
else if (x > 4095) then y = 255
else y = ((x - 2047.5) / 4095 + 0.5) * (255-0) + 0
```

$c=2048, w=1$ becomes:

```
if (x <= 2047.5) then y = 0
else if (x > 2047.5) then y = 255
else /* not reached */
```

$c=0, w=100$ becomes:

```
if (x <= -50) then y = 0
else if (x > 49) then y = 255
else y = ((x + 0.5) / 99 + 0.5) * (255-0) + 0
```

$c=0, w=1$ becomes:

```
if (x <= -0.5) then y = 0
else if (x > -0.5) then y = 255
else /* not reached */
```

4. A Window Center of 2^{n-1} and a Window Width of 2^n selects the range of input values from 0 to 2^n-1 . This represents an identity VOI LUT transformation in the case where no Modality LUT is specified and the stored pixel data are n bit unsigned integers.

5. A Window Width of 1 is typically used to represent a "threshold" operation in which those integer input values less than the Window Center are represented as the minimum displayed value and those greater than or equal to the Window Center are represented as the maximum displayed value. A Window Width of 2 will have the same result for integral input values.

6. The application of Window Center (0028,1050) and Window Width (0028,1051) may select a signed input range. There is no implication that this signed input range is clipped to zero.

7. The selected input range may exceed the actual range of the input values, thus effectively "compressing" the contrast range of the displayed data into a narrower band of the available contrast range, and "flattening" the appearance. There are no limits to the maximum value of the window width, or to the minimum or maximum value of window level, both of which may exceed the actual or possible range of input values.

8. Input values "below" the window are displayed as the minimum output value and input values "above" the window are displayed as the maximum output value. This is the common usage of the window operation in medical imaging. There is no provision for an alternative approach in which all values "outside" the window are displayed as the minimum output value.

9. The output of the Window Center/Width or VOI LUT transformation is either implicitly scaled to the full range of the display device if there is no succeeding transformation defined, or implicitly scaled to the full input range of the succeeding transformation step (such as the Presentation LUT), if present. See C.11.6.1.

10. Fractional values of Window Center and Window Width are permitted (since the VR of these Attributes is Decimal String), and though they are not often encountered, applications should be prepared to accept them.

These Attributes shall be used only for Images with Photometric Interpretation (0028,0004) values of MONOCHROME1 and MONOCHROME2. They have no meaning for other Images.

If multiple values are present, both Attributes shall have the same number of values and shall be considered as pairs. Multiple values indicate that multiple alternative views may be presented.

If any VOI LUT Table is included by an Image, a Window Width and Window Center or the VOI LUT Table, but not both, may be applied to the Image for display. Inclusion of both indicates that multiple alternative views may be presented.

If multiple items are present in VOI LUT Sequence (0028,3010), only one may be applied to the Image for display. Multiple items indicate that multiple alternative views may be presented.

If the VOI LUT Module is defined in an IOD and if neither a VOI LUT Sequence nor a Window Width and Window Center are present, then the VOI LUT stage of the grayscale pipeline is defined to be an identity transformation.

- Notes:
1. This requirement is specified so that IODs that define a particular output space for the grayscale pipeline, such as P-Values, are not in an undefined state when no VOI LUT Sequence or Window Width and Window Center are present.
 2. Despite the Type 3 requirement for VOI LUT Sequence and Window Center, implementations that render images are expected to implement and apply these transformations when they are present in the image.

C.11.3 LUT identification module

Table C.11-3 contains Attributes that identify a LUT IOD.

Table C.11-3
LUT Identification Module Attributes

Attribute Name	Tag	Type	Attribute Description
LUT Number	(0020,0026)	2	A number that identifies this LUT.

Referenced Image Sequence	(0008,1140)	3	A Sequence which provides reference to a set of Image SOP Class/Instance pairs to which this Look Up Table applies. One or more Items may be included in this Sequence.
>Referenced SOP Class UID	(0008,1150)	1C	Required if Referenced Image Sequence (0008,1140) is sent.
>Referenced SOP Instance UID	(0008,1155)	1C	Required if Reference Image Sequence (0008,1140) is sent.

C.11.4 Presentation LUT Module

Table C.11-4 specifies the Attributes that describe the Presentation LUT.

Table C.11-4
Presentation LUT Module

Attribute name	Tag	Description
Presentation LUT Sequence	(2050,0010)	Defines a sequence of Presentation LUTs. Only a single item shall be included in this sequence.
>LUT Descriptor	(0028,3002)	Specifies the format of the LUT Data in this Sequence. Required if Presentation LUT Sequence (2050,0010) is sent. See C.11.4.1 for further explanation.
>LUT Explanation	(0028,3003)	Free form text explanation of the meaning of the LUT.
>LUT Data	(0028,3006)	LUT Data in this Sequence.
Presentation LUT Shape	(2050,0020)	Specifies pre-defined Presentation LUT shapes. Enumerated Values : IDENTITY = input to the Presentation LUT is in P-Values, no further translation is necessary. LIN OD = input to Presentation LUT is in linear optical density over the range of Min Density (2010,0120) and Max Density (2010,1030). Note: LIN OD is only defined for hardcopy devices and is not applicable to softcopy devices.

C.11.4.1 LUT Descriptor

The three values of the LUT Descriptor (0028,3002) describe the format of the data in LUT Data (0028,3006).

The first value is the number of entries in the lookup table. When the number of table entries is equal to 2^{16} then this value shall be 0. The number of entries shall be equal to the number of possible values in the input. (For 8 bit input will be 256 entries, for 12 bit input it will be 4096 entries)

The second value is the first input value mapped, and shall always be 0. The Value Representation of the second value is always US. This input value is mapped to the first entry in the LUT. Subsequent input values are mapped to the subsequent entries in the LUT Data up to an input value

equal to number of entries + first value mapped - 1 which is mapped to the last entry in the LUT Data. There are no input values greater than number of entries - 1.

The third value specifies the number of bits for each entry in the LUT Data. It shall be between 10 and 16 inclusive. The LUT Data shall be stored in a format equivalent to 16 bits allocated where the high bit is equal to bits stored - 1, where bits stored is the third value.

Note: Since the LUT Descriptor (0028,3002) Attribute is multi-valued, in an Explicit VR Transfer Syntax, only one value representation (US or SS) may be specified. Since all three values are always by definition interpreted as unsigned, the explicit VR actually used will always be US.

LUT Data (0028,3006) contains the LUT entry values, which are P-Values.

The output range is from 0 to 2^n-1 where n is the third value of LUT Descriptor. This range is always unsigned.

This range specifies the output range of the P-Values.

C.11.5 Image Histogram Module

**Table C.11.5-1
IMAGE HISTOGRAM MODULE ATTRIBUTES**

Attribute name	Tag	Type	Description
Histogram Sequence	(0060,3000)	1	Defines a sequence of Histograms. One or more Items may be included in this Sequence.
>Histogram Number of Bins	(0060,3002)	1C	The number of "bins" (entries) in the histogram. Required if a Sequence Item is present.
>Histogram First Bin Value	(0060,3004)	1C	The stored pixel value corresponding to the lowest pixel value counted in the first bin. All image pixel values less than this value are not included in the histogram. Required if a Sequence Item is present. Note: The Value Representation of this Attribute is determined by the value of Pixel Representation (0028,0103).
>Histogram Last Bin Value	(0060,3006)	1C	The stored pixel value corresponding to the highest pixel value counted in the last bin. All image pixel values greater than this value are not included in the histogram. Required if a Sequence Item is present. Note: The Value Representation of this Attribute is determined by the value of Pixel Representation (0028,0103).
>Histogram Bin Width	(0060,3008)	1C	The number of consecutive stored pixel values included in a bin. All bins shall be of equal width. Required if a Sequence Item is present.
>Histogram Explanation	(0060,3010)	3	Free form text explanation of the meaning of the LUT.
>Histogram Data	(0060,3020)	1C	Histogram Data encoded as 32 bit unsigned counts of the number of pixel values in each bin. Required if a Sequence Item is present.

C.11.5.1 Image Histogram Attribute Descriptions

The Image Histogram is a multi-valued sequence representing a sequential count of binned stored image pixel values in ascending order.

Note: One reason to include a histogram with an image is as an aid to image processing applications. For applications that use them, computations of histograms for very large

images can be a significant burden on computer resources and can seriously degrade the response time to the user.

The Image Histogram is multi-valued to support multiple histograms per image. One or more regions of interest or value ranges may be separately computed. A description of the region(s) of interest and value range may be included in the Histogram Explanation (0060,3010). The Image Histogram may be related to parts or all of a specific image.

The Attributes describing the parameters of the histogram are in image pixel value space, as stored in Pixel Data (7FE0,0010), before the application of any transformation such as Rescale Slope and Intercept or Modality LUT.

The range of stored image pixel value instances is described by the Histogram First Bin Value (0060,3004) and Histogram Last Bin Value (0060,3006). All values outside of this range shall be ignored. The number of histogram bins shall be large enough to contain all of the pixels in the range from the smallest to the largest stored image pixel value in that region of the image from which the histogram has been derived (which may or may not be the whole image).

The Histogram Bin Width (0060,3008) describes how many consecutive stored image pixel values are counted as one. All bins shall be of equal width.

Note: For example, a Histogram Bin Width (0060,3008) of 8 means that counts of pixel values in ascending groups of 8 are added together. If Histogram First Bin Value (0060,3004) were 0, then the first bin would contain the count of pixel values in the range of 0-7, the second bin the count of pixel values in the range of 8-15, etc. If Histogram Number of Bins (0060,3002) were 32, then the last bin would contain the count of pixel values in the range of 248-255 and Histogram Last Bin Value (0060,3006) would be 255 (not 248).

This example is illustrated in the following figure, in which the vertical axis represents the count within each bin and the horizontal axis represents each bin in ascending order.

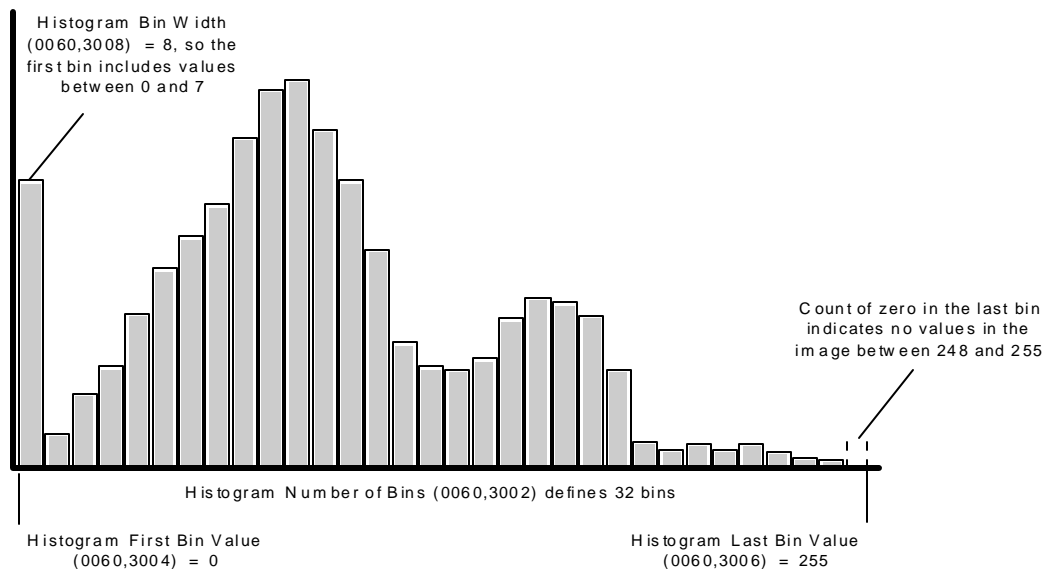

C.11.6 Softcopy Presentation LUT Module

Table C.11.6-1 specifies the Attributes that describe the Softcopy Presentation LUT.

**Table C.11.6-1
SOFTCOPY PRESENTATION LUT MODULE ATTRIBUTES**

Attribute name	Tag	Type	Description
Presentation LUT Sequence	(2050,0010)	1C	Defines a sequence of Presentation LUTs. Only a single item shall be included in this sequence. Required if Presentation LUT Shape (2050,0020) is absent.
>LUT Descriptor	(0028,3002)	1C	Specifies the format of the LUT Data in this Sequence. See C.11.6.1.1 for further explanation. Required if a Sequence Item is present.
>LUT Explanation	(0028,3003)	3	Free form text explanation of the meaning of the LUT.
>LUT Data	(0028,3006)	1C	LUT Data in this Sequence. Required if a Sequence Item is present.
Presentation LUT Shape	(2050,0020)	1C	Specifies predefined Presentation LUT transformation. Required if Presentation LUT Sequence (2050,0010) is absent. Enumerated Values: IDENTITY - no further translation necessary, input values are P-Values INVERSE - output values after inversion are P-Values See C.11.6.1.2.

Note: This Module differs from the Presentation LUT Module used in the hardcopy (print) related SOP Classes in that Optical Density is not supported for Presentation LUT Shape (since Optical Density has no meaning for softcopy display devices).

C.11.6.1 Softcopy Presentation LUT Attributes

When the Presentation LUT is specified as a Presentation LUT Sequence, then the input range of values is specified by the LUT Descriptor as the first value mapped and the number of entries (values mapped). However, there is an implicit linear scaling of the output range of the preceding transformation (such as the VOI LUT transformation) so that it is always mapped to the specified input range of the Presentation LUT.

When the Presentation LUT is specified as Presentation LUT Shape, then the input range is implicitly specified to be the output range of the preceding transformation (VOI LUT, or if the VOI LUT is identity or absent, the Modality LUT, or if the Modality LUT and VOI LUT are identity or absent, the stored pixel values). In this case, the full range of the output of the preceding transformation will be mapped to the full input range of the display device that receives the output of the Presentation LUT.

Note: The output of the preceding transformation may be signed. This does not mean that signed P-Values actually need to be generated, only that the output of the preceding transformation is to be interpreted by the display device as perceptually linear over the range from the minimum to the maximum values output by the preceding step, and that the minimum value be mapped to the lowest JND Index (and hence luminance) that the display can generate, and the maximum

value be mapped to the highest JND Index (and hence luminance) that the display can generate.

In other words, in both cases, the Presentation LUT Module is always implicitly specified to apply over the full range of output of the preceding transformation, and it never selects a subset or superset of the that range (unlike the VOI LUT).

The output bit precision of the VOI LUT Sequence is not required to match the input range of the Presentation LUT Sequence.

- Notes:
1. For example, if the VOI LUT is specified as a Window Center of 0 and a Window Width of 100, then the range from -50 to +49 is selected to be mapped to the full range of the display or print device (the full range of P-Values) if the Presentation LUT Shape is specified as IDENTITY or INVERSE. This example demonstrates the conventional understanding of the meaning of Window Center and Width to select “values of interest” that are to be displayed across the full range of the output device, without explicitly having to map each choice to P-Values.
 2. For example, if the VOI LUT is specified as a Window Center of 0 and a Window Width of 100, and the Presentation LUT Sequence is sent with a LUT Descriptor first value of 256 and second value of 0, then the range from -50 to +49 is implicitly linearly scaled from 0 to 255 before selecting values from the LUT Data in the Presentation LUT Sequence. This example demonstrates that it is not necessary to send a different Presentation LUT for different Window Center and Width values.
 3. For example, if the VOI LUT is specified as VOI LUT Sequence with a LUT Descriptor with a 3rd Value of 16, then the range from 0 to $2^{16}-1$ is selected to be mapped to the full range of the display or print device (the full range of P-Values) if the Presentation LUT Shape is specified as IDENTITY or INVERSE. This example demonstrates that a VOI LUT may be specified with the desired precision, without having to explicitly send a Presentation LUT to rescale that precision to whatever range of P-Values is preferred by the display application.
 4. For example, if the VOI LUT is specified as VOI LUT Sequence with a LUT Descriptor with a 3rd Value of 16, and the Presentation LUT Sequence is sent with a LUT Descriptor first value of 4096 and second value of 0, then the range from 0 to $2^{16}-1$ is implicitly linearly scaled to the range 0 to 4095 before selecting values from the LUT Data in the Presentation LUT Sequence. This example demonstrates the case where, to save space, the Presentation LUT is sent in a compact form that a display application may choose to interpolate more precisely, yet the VOI LUT output may be sent with 16 bit precision.

C.11.6.1.1 LUT Descriptor

The three values of the LUT Descriptor (0028,3002) describe the format of the LUT Data in the corresponding Data Element (0028,3006).

The first value is the number of entries in the lookup table. When the number of table entries is equal to 2^{16} then this value shall be 0.

The second value is the first implicitly scaled input value mapped, and shall always be 0. The Value Representation of the second value is always US. This implicitly scaled input value is mapped to the first entry in the LUT. There are no implicitly scaled input values less than the first value mapped. An implicitly scaled input value one greater than the first value mapped is mapped to the second entry in the LUT Data. Subsequent implicitly scaled input values are mapped to the subsequent entries in the LUT Data up to an implicitly scaled input value equal to number of entries + first value mapped - 1 which is mapped to the last entry in the LUT Data. There are no implicitly scaled input values greater than number of entries + first value mapped.

The third value specifies the number of bits for each entry in the LUT Data. The third value of the LUT Descriptor (0028,3002) shall be between 8 and 16 inclusive. The LUT Data shall be stored in a format equivalent to 8 or 16 bits allocated where the high bit is equal to bits stored - 1, where bits stored is the third value.

Note: Since the LUT Descriptor (0028,3002) Attribute is multi-valued, in an Explicit VR Transfer Syntax, only one value representation (US or SS) may be specified. Since all three values are always by definition interpreted as unsigned, the explicit VR actually used will always be US.

The LUT Data contains the LUT entry values, which are P-Values.

The output range is from 0 to 2^n-1 where n is the third value of LUT Descriptor. This range is always unsigned.

This range specifies the output range of the P-Values.

C.11.6.1.2 Presentation LUT Shape

A value of INVERSE shall mean the same as a value of IDENTITY, except that the minimum output value shall convey the meaning of the maximum available luminance, and the maximum value shall convey the minimum available luminance. In other words:

$$\text{P-Value} = \text{maximum value} - \text{output value}$$

C.11.7 Overlay/Curve Activation Module

This Module defines a manner of controlling whether or not bit-mapped overlay and curve information are displayed.

In the case of Curves, these Curves are contained within the referenced image(s).

Note: Curves may not be present within the Presentation State, since the same function is served by the Graphic Annotation Module which provides additional features.

In the case of Overlays, if the corresponding Overlay Group activated is present within the Presentation State, then that Overlay shall be activated and any corresponding Overlay in the referenced image(s) ignored, otherwise the Overlay within the referenced image(s) shall be activated.

An Overlay Group referenced in the Bitmap Display Shutter Module described in C.7.6.15 shall not be activated using the Overlay/Curve Activation Module.

Table C.11.7-1 specifies the Attributes that describe the Overlay/Curve Activation Module.

**Table C.11.7-1
OVERLAY/CURVE ACTIVATION MODULE ATTRIBUTES**

Attribute Name	Tag	Type	Attribute Description
Overlay Activation Layer	(60xx,1001)	2C	<p>The layer (defined in Graphic Layer (0070,0002) of the Graphic Layer Module C.10.7) in which the Overlay described in group 60xx shall be displayed. If no layer is specified (zero length) then the overlay shall not be displayed.</p> <p>Required if Group 60xx is present in the referenced image(s) or the Presentation State instance containing this Module.</p>
Curve Activation Layer	(50xx,1001)	2C	<p>The layer (defined in Graphic Layer (0070,0002) of the Graphic Layer Module C.10.7) in which the Curve described in group 50xx shall be displayed. If no layer is specified (zero length) then the curve shall not be displayed.</p> <p>Required if Group 50xx is present in the referenced image(s) and Type of Data (50xx,0020) is POLY or ROI.</p> <p>Note: Curves with other types of data are not expected to be displayed.</p>

Note: Those bits which are stored in Pixel data (7FE0,0010) above High Bit(0028,0102) may be used as overlay bit planes if they are referenced by an Overlay Bit Position (60xx,0102). If they are not so referenced, their contents are unspecified in DICOM and should not be displayed. Usually they will be zero, though if the pixel data is signed, i.e. Pixel Representation (0028,0103) is 0001H, then it is possible that the sign bit may be "extended" through these values. Alternatively, they may have been "masked off" even if the value is signed and negative.

C.11.8 Softcopy VOI LUT module

Table C.11.8-1 specifies the Attributes that describe the Softcopy VOI LUT. These Attributes have the same meaning and behavior as defined in the VOI LUT Module Section C.11.2.

Table C.11.8-1
SOFTCOPY VOI LUT MODULE ATTRIBUTES

Attribute Name	Tag	Type	Attribute Description
Softcopy VOI LUT Sequence	(0028,3110)	1	Defines a sequence of VOI LUTs or Window Centers and Widths and to which images and frames they apply. No more than one VOI LUT Sequence containing a single Item or one pair of Window Center/Width values shall be specified for each image or frame. One or more Items shall be present.
>Referenced Image Sequence	(0008,1140)	1C	Sequence of Repeating Items where each Item provides reference to a selected set of Image SOP Class/SOP Instance pairs that are defined in the Presentation State Module. Required if a sequence item is present, and if the VOI LUT transformation in this Item does not apply to all the images listed in the Presentation State Module.
>>Referenced SOP Class UID	(0008,1150)	1C	Uniquely identifies the referenced SOP Class. Required if sequence item is present.
>>Referenced SOP Instance UID	(0008,1155)	1C	Uniquely identifies the referenced SOP Instance. Required if sequence item is present.
>>Referenced Frame Number	(0008,1160)	1C	Identifies the frame numbers within the referenced SOP Instance to which this VOI LUT or Window Center and Width applies. Required if sequence item is present and the referenced image is a multi-frame image and the VOI LUT or Window Center and Width does not apply to all frames.
>VOI LUT Sequence	(0028,3010)	1C	Defines a sequence of VOI LUTs. Only one Item may be present. Required if Window Center (0028,1050) is not present.
>>LUT Descriptor	(0028,3002)	1C	Specifies the format of the LUT Data in this Sequence. See C.11.2.1.1 for further explanation. Required if the VOI LUT Sequence (0028,3010) is sent.
>>LUT Explanation	(0028,3003)	3	Free form text explanation of the meaning of the LUT.

>>LUT Data	(0028,3006)	1C	LUT Data in this Sequence. Required if the VOI LUT Sequence (0028,3010) is sent.
>Window Center	(0028,1050)	1C	Window Center for display. See C.11.2.1.2 for further explanation. Required if VOI LUT Sequence (0028,3010) is not present.
>Window Width	(0028,1051)	1C	Window Width for display. See C.11.2.1.2 for further explanation. Required if Window Center (0028,1050) is sent.
>Window Center & Width Explanation	(0028,1055)	3	Free form explanation of the meaning of the Window Center and Width.

C.11.9 Presentation Series Module

Table C.11.9-1 contains Attributes that identify and describe a Presentation Series.

**Table C.11.9-1
PRESENTATION SERIES MODULE ATTRIBUTES**

Attribute Name	Tag	Type	Attribute Description
Modality	(0008,0060)	1	Type of equipment that originally acquired the data. Enumerated Value: PR = Presentation State See C.7.3.1.1.1.

Note: This implies that presentation states will be in different series from the images to which they apply, which will have different values for Modality.

C.11.10 Presentation State Module

Table C.11.10-1 contains Attributes that identify and describe a Presentation State.

**Table C.11.10-1
PRESENTATION STATE MODULE ATTRIBUTES**

Attribute Name	Tag	Type	Attribute Description
Instance Number	(0020,0013)	1	A number that identifies this presentation (SOP Instance). Note: In previous versions of the Standard this Attribute was referred to as Image Number.
Presentation Label	(0070,0080)	1	A label that is used to identify this presentation. Note: This value may be used by an application as a Defined Term in order to imply some grouping of different presentation states, i.e. it may have the same value for different presentation state instances that share some common concept.
Presentation Description	(0070,0081)	2	A description of this presentation.
Presentation Creation Date	(0070,0082)	1	Date on which this presentation was created. Note: This date may be different from the date that the DICOM SOP Instance was created, since the presentation state information contained may have been recorded earlier.
Presentation Creation Time	(0070,0083)	1	Time at which this presentation was created. Note: This time may be different from the time that the DICOM SOP Instance was created, since the presentation state information contained may have been recorded earlier.
Presentation Creator's Name	(0070,0084)	2	Name of operator saving the presentation state (such as a technologist or physician).
Referenced Series Sequence	(0008,1115)	1	Sequence of Repeating Items where each Item includes the Attributes of one or more Series.
>Series Instance UID	(0020,000E)	1C	Unique identifier of a Series that is part of this Study. Required if sequence item is present.
>Retrieve AE Title	(0008,0054)	3	Title of the DICOM Application Entity where the Image(s) may be retrieved on the network.

>Storage Media File-Set ID	(0088,0130)	3	The user or implementation specific human readable identifier that identifies the Storage Media on which the Image(s) reside.
>Storage Media File-Set UID	(0088,0140)	3	Uniquely identifies the Storage Media on which the Image(s) reside.
>Referenced Image Sequence	(0008,1140)	1C	Sequence of Repeating Items where each Item provides reference to a selected set of Image SOP Class/SOP Instance pairs that are part of this Study and the Series defined by Series Instance UID (0020,000E). Required if a sequence item is present.
>>Referenced SOP Class UID	(0008,1150)	1C	Uniquely identifies the referenced SOP Class. Required if sequence item is present. Shall be the same for all Images referenced by this presentation state.
>>Referenced SOP Instance UID	(0008,1155)	1C	Uniquely identifies the referenced SOP Instance. Required if sequence item is present.
>>Referenced Frame Number	(0008,1160)	1C	Identifies the frame numbers within the referenced SOP Instance to which the presentation applies. Note: This Attribute may be multi-valued. Required if sequence item is present and the referenced SOP Instance is a multi-frame image and the presentation does not apply to all frames.
Shutter Presentation Value	(0018,1622)	1C	The value used to replace those parts of the image occluded by the shutter, in P-Values. Required if the Display Shutter Module or Bitmap Display Shutter Module is present. Note: The requirement in this module is type 1C which overrides the type 3 in the Display Shutter Module.

Mask Subtraction Sequence	(0028,6100)	1C	<p>Required if Mask Module is present.</p> <p>Only one Item shall be present.</p> <p>Applicable Frame Range (0028,6102) shall not be included in the Sequence Item.</p> <p>See C.7.6.10 for a complete definition of the Attributes in the Items of this Sequence other than Mask Operation(0028,6101) and Applicable Frame Range (0028,6102).</p> <p>Notes: 1. This Sequence is replicated here in order to specify one Item, additional conditions on Mask Operation (0028,6101) and to forbid Applicable Frame Range (0028,6102).</p> <p>2. The role of Applicable Frame Range (0028,6102) is replaced by Referenced Frame Number (0008,1160).</p>
>Mask Operation	(0028,6101)	1	<p>Type of mask operation to be performed</p> <p>Enumerated Values: AVG_SUB TID</p> <p>See C.7.6.10.1 for further explanation.</p> <p>Note: The requirement in this module is for Enumerated Values which override the requirements of the Mask Module.</p>
>Contrast Frame Averaging	(0028,6112)	1C	<p>Specified the number of contrast frames to average together before performing the mask operation.</p> <p>Required if Mask Frame Numbers (0028,6110) specifies more than one frame (i.e. is multi-valued).</p> <p>Note: The requirement in this module is conditional and overrides the optional requirements of the Mask Module.</p>
Recommended Viewing Mode	(0028,1090)	1C	<p>Specifies the recommended viewing protocol(s).</p> <p>Enumerated Value: SUB = for subtraction with mask images</p> <p>Required if Mask Subtraction Sequence (0028,6100) is present.</p> <p>Note: The requirement in this module is type 1C and an Enumerated Value is specified which override the requirements of the Mask Module.</p>

C.12 GENERAL MODULES

The SOP Common Module shall be mandatory for all DICOM IODs.

C.12.1 SOP Common Module

Table C.12-1 defines the Attributes which are required for proper functioning and identification of the associated SOP Instances. They do not specify any semantics about the Real-World Object represented by the IOD.

Table C.12-1
SOP COMMON MODULE ATTRIBUTES

Attribute Name	Tag	Type	Attribute Description
SOP Class UID	(0008,0016)	See C.12.1.1.1	Uniquely identifies the SOP Class. See PS 3.4.
SOP Instance UID	(0008,0018)	See C.12.1.1.1	Uniquely identifies the SOP Instance. See PS 3.4.
Specific Character Set	(0008,0005)	1C	Character Set that expands or replaces the Basic Graphic Set. Required if an expanded or replacement character set is used. See C.12.1.1.2 for Defined Terms.
Instance Creation Date	(0008,0012)	3	Date the SOP Instance was created.
Instance Creation Time	(0008,0013)	3	Time the SOP Instance was created.
Instance Creator UID	(0008,0014)	3	Uniquely identifies device which created the SOP Instance.

Timezone Offset From UTC	(0008,0201)	3	<p>Contains the offset from UTC to the timezone for all DA and TM Attributes present in this SOP Instance.</p> <p>Encoded as an ASCII string in the format "&ZZZZ". The components of this string, from left to right, are & = "+" or "-", and ZZZZ = Hours and Minutes of offset.</p> <p>Notes:</p> <ol style="list-style-type: none"> 1. This encoding is the same as described in PS 3.5 for the DT Value Representation. 2. This Attribute does not apply to values with a DT Value Representation, which may contain an explicitly encoded timezone. 3. The corrected time may cross a 24 hour boundary. For example, if Local Time = 1.00 a.m. and Offset = +0200, then UTC = 11.00 p.m. (23.00) the day before. 4. The "+" sign may not be omitted. <p>Time earlier than UTC is expressed as a negative offset.</p> <p>Note: For example: UTC = 5.00 a.m. Local Time = 3.00 a.m. Offset = -0200</p> <p>The local timezone offset is undefined if this Attribute is absent.</p>
Instance Number	(0020,0013)	3	<p>A number that identifies this Composite object instance.</p>

SOP Instance Status	(0100,0410)	3	<p>A flag that indicates the storage status of the SOP Instance. Not Specified (NS) implies that this SOP Instance has no special storage status, and hence no special actions need be taken. Original (OR) implies that this is the primary SOP instance for the purpose of storage, but that it has not yet been authorized for diagnostic use. Authorized Original (AO) implies that this is the primary SOP instance for the purpose of storage, which has been authorized for diagnostic use. Any copies of an Authorized Original should be given the status of Authorized Copy. Authorized Copy (AC) implies that this is a copy of an Authorized Original SOP Instance.</p> <p>Enumerated Values: NS, OR, AO, AC</p> <p>Note: Proper use of these flags is specified in Security Profiles. Implementations that do not conform to such Security Profiles may not necessarily handle these flags properly.</p>
SOP Authorization Date and Time	(0100,0420)	3	The date and time when the SOP Instance Status (0100,0410) was set to AO.
SOP Authorization Comment	(0100,0424)	3	Any comments associated with the setting of the SOP Instance Status (0100,0410) to AO.
Authorization Equipment Certification Number	(0100,0426)	3	The certification number issued to the Application Entity that set the SOP Instance Status (0100,0410) to AO.
<i>Include 'Digital Signatures Macro' Table C.12-5</i>			

C.12.1.1 SOP Common Attribute Descriptions

C.12.1.1.1 SOP Class UID, SOP Instance UID

The SOP Class UID and SOP Instance UID Attributes are defined for all DICOM IODs. However, they are only encoded in Composite IODs with the Type equal to 1. When encoded they shall be equal to their respective Attributes in the DIMSE Services and the File Meta Information header (see PS 3.10 Media Storage).

C.12.1.1.2 Specific Character Set

Specific Character Set (0008,0005) identifies the Character Set that expands or replaces the Basic Graphic Set (ISO 646) for values of Data Elements that have Value Representation of SH, LO, ST, PN, LT or UT. See PS 3.5.

If the Attribute Specific Character Set (0008,0005) is not present or has only a single value, Code Extension techniques are not used. Defined terms for the Attribute Specific Character Set (0008,0005), when single valued, are derived from the International Registration Number as per ISO 2375 (e.g., ISO_IR 100 for Latin alphabet No. 1). See Table C.12-2.

**Table C.12-2
DEFINED TERMS FOR SINGLE-BYTE CHARACTER SETS WITHOUT CODE EXTENSIONS**

Character Set Description	Defined Term	ISO registration number	Number of characters	Code element	Character Set
Default repertoire	none	ISO-IR 6	94	G0	ISO 646
Latin alphabet No. 1	ISO_IR 100	ISO-IR 100	96	G1	Supplementary set of ISO 8859
		ISO-IR 6	94	G0	ISO 646
Latin alphabet No. 2	ISO_IR 101	ISO-IR 101	96	G1	Supplementary set of ISO 8859
		ISO-IR 6	94	G0	ISO 646
Latin alphabet No. 3	ISO_IR 109	ISO-IR 109	96	G1	Supplementary set of ISO 8859
		ISO-IR 6	94	G0	ISO 646
Latin alphabet No. 4	ISO_IR 110	ISO-IR 110	96	G1	Supplementary set of ISO 8859
		ISO-IR 6	94	G0	ISO 646
Cyrillic	ISO_IR 144	ISO-IR 144	96	G1	Supplementary set of ISO 8859
		ISO-IR 6	94	G0	ISO 646
Arabic	ISO_IR 127	ISO-IR 127	96	G1	Supplementary set of ISO 8859
		ISO-IR 6	94	G0	ISO 646
Greek	ISO_IR 126	ISO-IR 126	96	G1	Supplementary set of ISO 8859
		ISO-IR 6	94	G0	ISO 646
Hebrew	ISO_IR 138	ISO-IR 138	96	G1	Supplementary set of ISO 8859
		ISO-IR 6	94	G0	ISO 646
Latin alphabet No. 5	ISO_IR 148	ISO-IR 148	96	G1	Supplementary set of ISO 8859
		ISO-IR 6	94	G0	ISO 646
Japanese	ISO_IR 13	ISO-IR 13	94	G1	JIS X 0201: Katakana
		ISO-IR 14	94	G0	JIS X 0201: Romaji
Thai	ISO_IR 166	ISO-IR 166	88	G1	TIS 620-2533 (1990)
		ISO-IR 6	94	G0	ISO 646

Note: To use the single-byte code table of JIS X0201, the value of attribute Specific Character Set (0008,0005), value 1 should be ISO_IR 13. This means that ISO-IR 13 is designated as the G1 code element which is invoked in the GR area. It should be understood that, in addition, ISO-IR 14 is designated as the G0 code element and this is invoked in the GL area.

If the attribute Specific Character Set (0008,0005) has more than one value, Code Extension techniques are used and Escape Sequences may be encountered in all character sets. Requirements for the use of Code Extension techniques are specified in PS 3.5. In order to indicate the presence of Code Extension, the Defined Terms for the repertoires have the prefix "ISO 2022", e.g., ISO 2022 IR 100 for the Latin Alphabet No. 1. See Table 12-3 and Table 12-4. Table 12-3 describes single-byte character sets for value 1 to value n of the attribute Specific Character Set (0008,0005), and Table 12-4 describes multi-byte character sets for value 2 to value n of the attribute Specific Character Set (0008,0005).

Note: A prefix other than "ISO 2022" may be needed in the future if other Code Extension techniques are adopted.

Table C.12-3
DEFINED TERMS FOR SINGLE-BYTE CHARACTER SETS WITH CODE EXTENSIONS

Character Set Description	Defined Term	Standard for Code Extension	ESC sequence	ISO registration number	Number of characters	Code element	Character Set
Default repertoire	ISO 2022 IR 6	ISO 2022	ESC 02/08 04/02	ISO-IR 6	94	G0	ISO 646
Latin alphabet No. 1	ISO 2022 IR 100	ISO 2022	ESC 02/13 04/01	ISO-IR 100	96	G1	Supplementary set of ISO 8859
		ISO 2022	ESC 02/08 04/02	ISO-IR 6	94	G0	ISO 646
Latin alphabet No. 2	ISO 2022 IR 101	ISO 2022	ESC 02/13 04/02	ISO-IR 101	96	G1	Supplementary set of ISO 8859
		ISO 2022	ESC 02/08 04/02	ISO-IR 6	94	G0	ISO 646
Latin alphabet No. 3	ISO 2022 IR 109	ISO 2022	ESC 02/13 04/03	ISO-IR 109	96	G1	Supplementary set of ISO 8859
		ISO 2022	ESC 02/08 04/02	ISO-IR 6	94	G0	ISO 646
Latin alphabet No. 4	ISO 2022 IR 110	ISO 2022	ESC 02/13 04/04	ISO-IR 110	96	G1	Supplementary set of ISO 8859
		ISO 2022	ESC 02/08 04/02	ISO-IR 6	94	G0	ISO 646
Cyrillic	ISO 2022 IR 144	ISO 2022	ESC 02/13 04/12	ISO-IR 144	96	G1	Supplementary set of ISO 8859
		ISO 2022	ESC 02/08 04/02	ISO-IR 6	94	G0	ISO 646
Arabic	ISO 2022 IR 127	ISO 2022	ESC 02/13 04/07	ISO-IR 127	96	G1	Supplementary set of ISO 8859
		ISO 2022	ESC 02/08 04/02	ISO-IR 6	94	G0	ISO 646
Greek	ISO 2022 IR 126	ISO 2022	ESC 02/13 04/06	ISO-IR 126	96	G1	Supplementary set of ISO 8859

		ISO 2022	ESC 02/08 04/02	ISO-IR 6	94	G0	ISO 646
Hebrew	ISO 2022 IR 138	ISO 2022	ESC 02/13 04/08	ISO-IR 138	96	G1	Supplementary set of ISO 8859
		ISO 2022	ESC 02/08 04/02	ISO-IR 6	94	G0	ISO 646
Latin alphabet No. 5	ISO 2022 IR 148	ISO 2022	ESC 02/13 04/13	ISO-IR 148	96	G1	Supplementary set of ISO 8859
		ISO 2022	ESC 02/08 04/02	ISO-IR 6	94	G0	ISO 646
Japanese	ISO 2022 IR 13	ISO 2022	ESC 02/0 9 04/09	ISO-IR 13	94	G1	JIS X 0201: Katakana
		ISO 2022	ESC 02/08 04/10	ISO-IR 14	94	G0	JIS X 0201: Romaji
Thai	ISO 2022 IR 166	ISO 2022	ESC 02/13 05/04	ISO-IR 166	88	G1	TIS 620-2533 (1990)
		ISO 2022	ESC 02/08 04/02	ISO-IR 6	94	G0	ISO 646

Note: If the attribute Specific Character Set (0008,0005) has more than one value and value 1 is empty, it is assumed that value 1 is ISO 2022 IR 6.

Table C.12-4
DEFINED TERMS FOR MULTI-BYTE CHARACTER SETS WITH CODE EXTENSIONS

Character Set Description	Defined Term	Standard for Code Extension	ESC sequence	ISO registration number	Number of characters	Code element	Character Set
Japanese	ISO 2022 IR 87	ISO 2022	ESC 02/04 04/02	ISO-IR 87	942	G0	JIS X 0208: Kanji
	ISO 2022 IR 159	ISO 2022	ESC 02/04 02/08 04/04	ISO-IR 159	942	G0	JIS X 0212: Supplementary Kanji set
Korean	ISO 2022 IR 149	ISO 2022	ESC 02/04 02/09 04/03	ISO-IR 149	942	G1	KS X 1001: Hangul and Hanja

C.12.1.1.3 Digital Signatures Macro

This Macro allows Digital Signatures to be included in a DICOM Data Set for the purpose of insuring the integrity of the Data Set, and to authenticate the sources of the Data Set. Table C.12-5 defines the Attributes needed to embed a Digital Signature in a Data Set. This Macro may appear in individual sequence items as well as in the main Data Set of the SOP Instance.

Note: Each Item of a Sequence of Items is a Data Set. Thus, individual Sequence items may incorporate their own Digital Signatures in addition to any Digital Signatures added to the Data Set in which the Sequence appears.

Table C.12-5
DIGITAL SIGNATURES MACRO ATTRIBUTES

Attribute Name	Tag	Type	Attribute Description
MAC Parameters Sequence	(4FFE,0001)	3	A sequence of one or more items that describe the parameters used to calculate a MAC for use in Digital Signatures.
>MAC ID Number	(0400,0005)	1	A number used to identify this MAC Parameters Sequence item.
>MAC Calculation Transfer Syntax UID	(0400,0010)	1	The Transfer Syntax UID used to encode the values of the Data Elements included in the MAC calculation. Only Transfer Syntaxes that explicitly include the VR and use Little Endian encoding shall be used. Notes: Certain Transfer Syntaxes, particularly those that are used with compressed data, allow the fragmentation of the pixel data to change. If such fragmentation changes, Digital Signatures generated with such Transfer Syntaxes could become invalid.
>MAC Algorithm	(0400,0015)	1	The algorithm used in generating the MAC to be encrypted to form the Digital Signature. Defined Terms: RIPEMD160 MD5 SHA1 Note: Digital Signature Security Profiles (see PS 3.15) may require the use of a restricted subset of these terms.
>Data Elements Signed	(0400,0020)	1	A list of Data Element Tags in the order they appear in the Data Set which identify the Data Elements used in creating the MAC for the Digital Signature. See Section C.12.1.1.3.1.1.
Digital Signatures Sequence	(FFFA,FFFA)	3	Sequence holding one or more Digital Signatures.
>MAC ID Number	(0400,0005)	1	A number used to identify which MAC Parameters Sequence item was used in the calculation of this Digital Signature.
>Digital Signature UID	(0400,0100)	1	A UID that can be used to uniquely reference this signature.
>Digital Signature DateTime	(0400,0105)	1	The date and time the Digital Signature was created. The time shall include an offset (i.e., time zone indication) from Coordinated Universal Time. Note: This is not a certified timestamp, and

			hence is not completely verifiable. An application can compare this date and time with those of other signatures and the validity date of the certificate to gain confidence in the veracity of this date and time.
>Certificate Type	(0400,0110)	1	The type of certificate used in (0400,0115). Defined Term: X509_1993_SIG Note: Digital Signature Security Profiles (see PS 3.15) may require the use of a restricted subset of these terms.
>Certificate of Signer	(0400,0115)	1	A certificate that holds the identity of the entity producing this Digital Signature, that entity's public key or key identifier, and the algorithm and associated parameters with which that public key is to be used. Algorithms allowed are specified in Digital Signature Security Profiles (see PS 3.15). Notes: 1. As technology advances, additional encryption algorithms may be allowed in future versions. Implementations should take this possibility into account. 2. When symmetric encryption is used, the certificate merely identifies which key was used by which entity, but not the actual key itself. Some other means (e.g., a trusted third party) must be used to obtain the key.
>Signature	(0400,0120)	1	The MAC generated as described in Section 12.2.1.1 and encrypted using the algorithm, parameters, and private key associated with the Certificate of the Signer (0400,0115). See Section C.12.1.1.3.1.2.
>Certified Timestamp Type	(0400,0305)	1C	The type of certified timestamp used in the Certified Timestamp (0400,0310) Attribute. Required if Certified Timestamp (0400,0310) is present. Defined Terms: CMS_TSP – Internet X.509 Public Key Infrastructure Time Stamp Protocol Note: Digital Signature Security Profiles (see PS 3.15) may require the use of a restricted subset of these terms.
>Certified Timestamp	(0400,0310)	3	A certified timestamp of the Digital Signature (0400,0120) Attribute Value, which shall be obtained when the Digital Signature is created. See Section C.12.1.1.3.1.3.

C.12.1.1.3.1 Digital Signature Attribute Descriptions

C.12.1.1.3.1.1 Data Elements Signed

The Data Elements Signed Attribute shall list the Tags of the Data Elements that are included in the MAC calculation. The Tags listed shall reference Data Elements at the same level as the Mac Parameters Sequence (4FFE,0001) Data Element in which the Data Elements Signed Attribute appears. Tags included in Data Elements Signed shall be listed in the order in which they appear within the Data Set.

The following Data Elements shall not be included either implicitly or explicitly in the list of Tags in Data Elements Signed, nor included as part of the MAC calculation:

- The Length to End (0008,0001) or any Tag with an element number of 0000 (i.e., no data set or group lengths may be included in MAC calculations)
- Tags with a group number less than 0008
- Tags associated with Data Elements whose VR is UN
- Tags of Data Elements whose VR is SQ, where any Data Element within that Sequence of Items has a VR of UN recursively
- Tags with a group number of FFFA (e.g. the Digital Signatures Sequence)
- MAC Parameters Sequence (4FFE,0001)
- Data Set Trailing Padding (FFFC,FFFC)
- Item Delimitation Item (FFFE,E00D)

- Notes:
1. The Length to End and group lengths can change if non-signed Data Elements change, so it is not appropriate to include them in the MAC calculation.
 2. Since the Data Element Tags identifying a sequence and which start each item are included in the MAC calculation, there is no need to include the Item Delimitation Item Tags.

If any of the Data Element Tags in the list refer to a Sequence of Items, then the Tags of all Data Elements within all Items of that Sequence shall be implicitly included in the list of Data Elements Signed, except those disallowed above. This implicit list shall also include the Item Tag (FFFE,E000) Data Elements that separate the Sequence Items and the Sequence Delimitation Item (FFFE,E0DD).

Notes: It is possible to sign individual items within a sequence by including the Digital Signatures Macro in that sequence item. In fact, this is a highly desirable feature, particular when used in the context of reports. The Digital Signatures Macro is applied at the Data Set level, and Sequences of Items are merely Data Sets embedded within a larger Data Set. Essentially, the Digital Signature Macro may be applied recursively.

An example of nesting Digital Signatures within Data Elements is illustrated in the following figure:

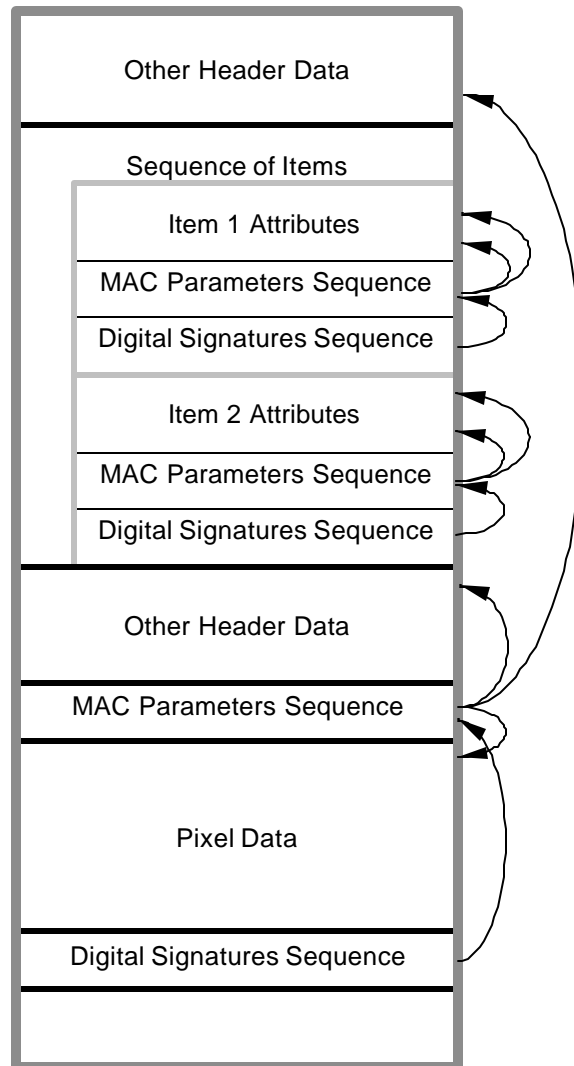

In this example, there is main signature covering the pixel data and a few other Data Elements, plus two individually signed items within a sequence.

For Data Elements with a VR OB (e. g. pixel data) that have an undefined length (i.e. the data is encapsulated as described in PS 3.5), the Item Data Element Tags that separate the fragments shall implicitly be included in the list of Data Elements Signed (i.e. a Data Element with a VR of OB is encoded in the same fashion as a Sequence of Items).

C.12.1.1.3.1.2 Signature

To generate the MAC, Data Elements referenced either explicitly or implicitly by the Tags in the Data Elements Signed list shall be encoded using the Transfer Syntax identified by the MAC Calculation Transfer Syntax UID (0400,0010) of the MAC Parameters Sequence item where the Data Elements Signed Attribute appears. Data shall be formed into a byte stream and presented to the MAC Algorithm for computation of the MAC according to the following rules:

For all Data Elements except those with a VR of SQ or with a VR of OB with an undefined length, all Data Element fields, including the Tag, the VR, the reserved field (if any), the Value Length, and the Value, shall be placed into the byte stream in the order encountered.

For Data Elements with a VR of SQ or with a VR of OB with an undefined length, the Tag, the VR, and the reserved field are placed into the byte stream. The Value Length shall not be included. This is followed by each Item Tag in the order encountered, without including the Value Length, followed by the contents of the Value for that item. In the case of an Item within a Data Element whose VR is SQ, these rules are applied recursively to all of the Data Elements within the Value of that Item. After all the Items have been incorporate into the byte stream, a Sequence Delimitation Item Tag (FFFE,E0DD) shall be added to the byte stream presented to the MAC Algorithm, regardless of whether or not it was originally present.

Note: Since the Value Length of Data Elements with a VR of SQ can be either explicit or undefined, the Value Lengths of such Data Elements are left out of the MAC calculation. Similarly, the Value Length of Data Elements with a VR of OB with an undefined length are also left out so that they are handled consistently. If such Data Elements do come with undefined lengths, including the Item Tags that separate the Items or fragments insures that Data Elements cannot be moved between Items or Fragments without compromising the Digital Signature. For those Data Elements with explicit lengths, if the length of an item changes, the added or removed portions would also impact the MAC calculation, so it is not necessary to include explicit lengths in the MAC calculation. It is possible that including the Value Lengths could make cryptanalysis easier.

After the fields of all the Data Elements in the Data Elements Signed list have been placed into the byte stream presented to the MAC Algorithm according to the above rules, all of the Data Elements within the Digital Signatures Sequence item except the Certificate of Signer (0400,0115), Signature (0400,0120), Certified Timestamp Type (0400,0305), and Certified Timestamp (0400,0310) shall also be encoded according to the above rules, and presented to the MAC algorithm (i.e., the Attributes of the Digital Signature Sequence Item for this particular Digital Signature are also implicitly included in the list of Data Elements Signed, except as noted above).

The resulting MAC code after processing this byte stream by the MAC Algorithm is then encrypted as specified in the Certificate of Signer and placed in the Value of the Signature Data Element.

Notes:

1. The Transfer Syntax used in the MAC calculation may differ from the Transfer Syntax used to exchange the Data Set.
2. Digital Signatures require explicit VR in order to calculate the MAC. An Application Entity which receives a Data Set with an implicit VR Transfer Syntax may not be able to verify Digital Signatures that include Private Data Elements or Data Elements unknown to that Application Entity. This also true of any Data Elements whose VR is UN. Without knowledge of the Value Representation, the receiving Application Entity would be unable to perform proper byte swapping or be able to properly parse sequences in order to generate a MAC.

3. If more than one entity signs, each Digital Signature would appear in its own Digital Signatures Sequence item. The Digital Signatures may or may not share the same MAC Parameters Sequence item.
4. The notion of a notary public (i.e., someone who verifies the identity of the signer) for Digital Signatures is partially filled by the authority that issued the Certificate of Signer.

C.12.1.1.3.1.3 Certified Timestamp

To generate a certified timestamp, the Value of the Signature (0400,0120) Attribute is sent to a third party, as specified by the protocol referred to by the Certified Timestamp Type (0400,0305) Attribute. The third party then generates and returns a certified timestamp in the form specified by that protocol. The certified timestamp returned by the third party is encoded as a stream of bytes in the Certified Timestamp Attribute.

Note: The timestamp protocol may be specified by a Profile in PS 3.15.

C.13 PRINT MANAGEMENT SPECIFIC MODULES

The following Sections specify Modules used for Print Management.

C.13.1 Basic Film Session Presentation Module

**Table C.13-1
BASIC FILM SESSION PRESENTATION MODULE ATTRIBUTES**

Attribute name	Tag	Attribute Description
Number of Copies	(2000,0010)	Number of copies to be printed for each film of the film session.
Print Priority	(2000,0020)	Specifies the priority of the print job. Enumerated Values: HIGH MED LOW
Medium Type	(2000,0030)	Type of medium on which the print job will be printed. Defined Terms: PAPER CLEAR FILM BLUE FILM
Film Destination	(2000,0040)	Film destination. Defined Terms: MAGAZINE = the exposed film is stored in film magazine PROCESSOR = the exposed film is developed in film processor BIN_i = the exposed film is deposited in a sorter bin where "i" represents the bin number. Film sorter BINs shall be numbered sequentially starting from one and no maximum is placed on the number of BINs. The encoding of the BIN number shall not contain leading zeros.
Film Session Label	(2000,0050)	Human readable label that identifies the film session
Memory Allocation	(2000,0060)	Amount of memory allocated for the film session. Value is expressed in KB
Owner ID	(2100,0160)	Identification of the owner of the film session

C.13.2 Basic Film Session Relationship Module

**Table C.13-2
BASIC FILM SESSION RELATIONSHIP MODULE ATTRIBUTES**

Attribute Name	Tag	Attribute Description
Referenced Film Box Sequence	(2000,0500)	A Sequence which provides references to a set of Film Box SOP Class/Instance pairs. Zero or more Items may be included in this Sequence.
>Referenced SOP Class UID	(0008,1150)	Uniquely identifies the referenced SOP Class.
>Referenced SOP Instance UID	(0008,1155)	Uniquely identifies the referenced SOP Instance.

Proposed Study Sequence	(2130,00A0)	Attributes that may be used to identify Stored Print Storage and Hardcopy Image SOP Instances created to store this Film Session.
>Patient's Name	(0010,0010)	See C.2.2 for description.
>Patient ID	(0010,0020)	See C.2.2 for description.
>Patient's Birth Date	(0010,0030)	See C.2.3 for description.
>Patient's Sex	(0010,0040)	See C.2.3 for description.
>Patient's Birth Time	(0010,0032)	See C.2.3 for description.
>Other Patient ID	(0010,1000)	See C.2.2 for description.
>Other Patient Names	(0010,1001)	See C.2.2 for description.
>Ethnic Group	(0010,2160)	See C.2.3 for description.
>Patient Comments	(0010,4000)	See C.2.3 for description.
>Study Instance UID	(0020,000D)	See C.4.1 for description.
>Study Date	(0008,0020)	See C.4.5 for description.
>Study Time	(0008,0030)	See C.4.5 for description.
>Referring Physician's Name	(0008,0090)	See C.3.4 for description.
>Study ID	(0020,0010)	See C.4.2 for description.
>Accession Number	(0008,0050)	See C.4.1 for description.
>Study Description	(0008,1030)	See C.4.9 for description.
>Name of Physician(s) Reading Study	(0008,1060)	See C.7.2.1 for description.
>Admitting Diagnoses Description	(0008,1080)	See C.7.2.2 for description.
>Patient's Age	(0010,1010)	See C.2.3 for description.
>Patient's Size	(0010,1020)	See C.2.3 for description.
>Patient's Weight	(0010,1030)	See C.2.3 for description.
>Occupation	(0010,2180)	See C.2.3 for description.
>Additional Patient's History	(0010,21B0)	See C.2.4 for description.
>Series Number	(0020,0011)	See C.7.3.1 for description

C.13.3 Basic Film Box Presentation Module

Table C.13-3
BASIC FILM BOX PRESENTATION MODULE ATTRIBUTES

Attribute Name	Tag	Attribute Description
Image Display Format	(2010,0010)	<p>Type of image display format. Enumerated Values:</p> <p>STANDARD\C,R : film contains equal size rectangular image boxes with R rows of image boxes and C columns of image boxes; C and R are integers.</p> <p>ROW\R1,R2,R3, etc. : film contains rows with equal size rectangular image boxes with R1 image boxes in the first row, R2 image boxes in second row, R3 image boxes in third row, etc.; R1, R2, R3, etc. are integers.</p> <p>COL\C1,C2,C3, etc.: film contains columns with equal size rectangular image boxes with C1 image boxes in the first column, C2 image boxes in second column, C3 image boxes in third column, etc.; C1, C2, C3, etc. are integers.</p> <p>SLIDE : film contains 35mm slides; the number of slides for a particular film size is configuration dependent.</p> <p>SUPERSLIDE : film contains 40mm slides; the number of slides for a particular film size is configuration dependent.</p> <p>CUSTOM<i>i</i> : film contains a customized ordering of rectangular image boxes; i identifies the image display format; the definition of the image display formats is defined in the Conformance Statement; i is an integer</p>
Annotation Display Format ID	(2010,0030)	<p>Identification of annotation display format. The definition of the annotation display formats and the annotation box position sequence are defined in the Conformance Statement</p>
Film Orientation	(2010,0040)	<p>Film orientation. Enumerated Values:</p> <p> PORTRAIT = vertical film position</p> <p> LANDSCAPE = horizontal film position</p>

Film Size ID	(2010,0050)	<p>Film size identification. Defined Terms:</p> <p>8INX10IN 8_5INX11IN 10INX12IN 10INX14IN 11INX14IN 11INX17IN 14INX14IN 14INX17IN 24CMX24CM 24CMX30CM A4 A3</p> <p>Note: 10INX14IN corresponds with 25.7CMX36.4CM A4 corresponds with 210 x 297 millimeters A3 corresponds with 297 x 420 millimeters</p>
Magnification Type	(2010,0060)	<p>Interpolation type by which the printer magnifies or decimates the image in order to fit the image in the image box on film. Defined Terms:</p> <p>REPLICATE BILINEAR CUBIC NONE</p>
Smoothing Type	(2010,0080)	<p>Further specifies the type of the interpolation function. Values are defined in Conformance Statement. Only valid for Magnification Type (2010,0060) = CUBIC</p>
Border Density	(2010,0100)	<p>Density of the film areas surrounding and between images on the film. Defined Terms:</p> <p>BLACK WHITE</p> <p>i where i represents the desired density in hundreds of OD (e.g. 150 corresponds with 1.5 OD)</p>
Empty Image Density	(2010,0110)	<p>Density of the image box area on the film that contains no image. Defined Terms:</p> <p>BLACK WHITE</p> <p>i where i represents the desired density in hundredths of OD (e.g. 150 corresponds with 1.5 OD)</p>
Min Density	(2010,0120)	<p>Minimum density of the images on the film, expressed in hundredths of OD. If Min Density is lower than minimum printer density than Min Density is set to minimum printer density.</p>

Max Density	(2010,0130)	Maximum density of the images on the film, expressed in hundredths of OD. If Max Density is higher than maximum printer density than Max Density is set to maximum printer density.
Trim	(2010,0140)	Specifies whether a trim box shall be printed surrounding each image on the film. Enumerated Values: YES NO
Configuration Information	(2010,0150)	Character string that contains either the ID of the printer configuration table that contains a set of values for implementation specific print parameters (e.g. perception LUT related parameters) or one or more configuration data values, encoded as characters. If there are multiple configuration data values encoded in the string, they shall be separated by backslashes. The definition of values shall be contained in the SCP's Conformance Statement. Defined Terms: CS000-CS999: Implementation specific curve type. Note: It is recommended that for SCPs, CS000 represent the lowest contrast and CS999 the highest contrast levels available.
Illumination	(2010,015E)	Luminance of lightbox illuminating a piece of transmissive film, or for the case of reflective media, luminance obtainable from diffuse reflection of the illumination present. Expressed as L_0 , in candelas per square meter (cd/m^2).
Reflected Ambient Light	(2010,0160)	For transmissive film, luminance contribution due to reflected ambient light. Expressed as L_a , in candelas per square meter (cd/m^2).
Requested Resolution ID	(2020,0050)	Specifies the resolution at which images in this Film Box are to be printed. Defined Terms: STANDARD = approximately 4k x 5k printable pixels on a 14 x 17 inch film HIGH = Approximately twice the resolution of STANDARD.

C.13.3.1 Image display format

C.13.3.1.1 Standard image display format

The standard format subdivides a film into image boxes of equal size. Therefore, the film layout is fully symmetrical, i.e. the arrangement of image boxes on film is left-right and top-bottom symmetric.

Example : STANDARD\3,4

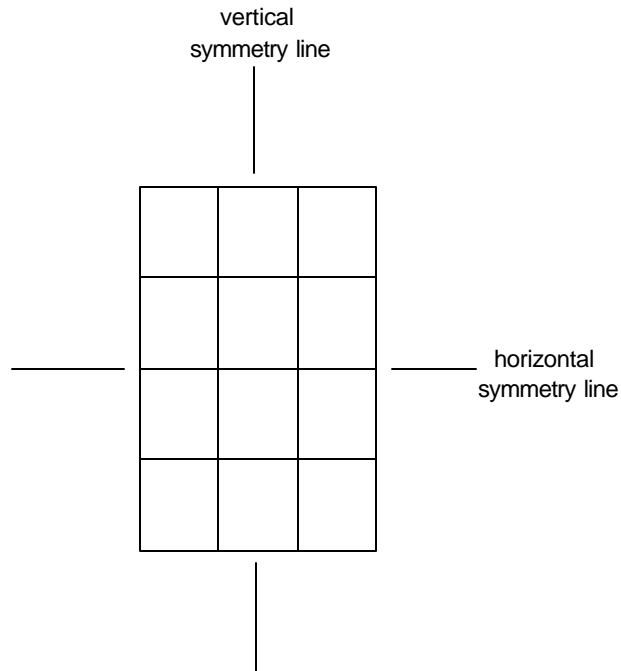

C.13.3.1.2 Row symmetric image display format

The row symmetric image display format subdivides a film into rows of image boxes of equal size. As a result, the layout is left-right symmetric, the associated symmetry line is vertical (V). There is no top-bottom symmetry.

Example : ROW\2,3

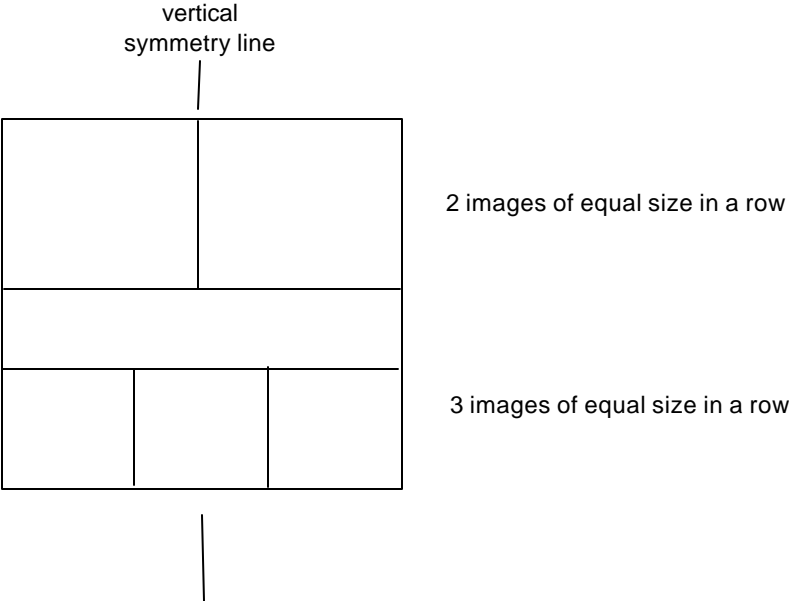

C.13.3.1.3 Column symmetric image display format

The column symmetric image display format subdivides a film into columns of image boxes of equal size. As a result, the layout is top-bottom symmetric, the associated symmetry line is horizontal (H). There is no left-right symmetry.

Example : COL\1,4

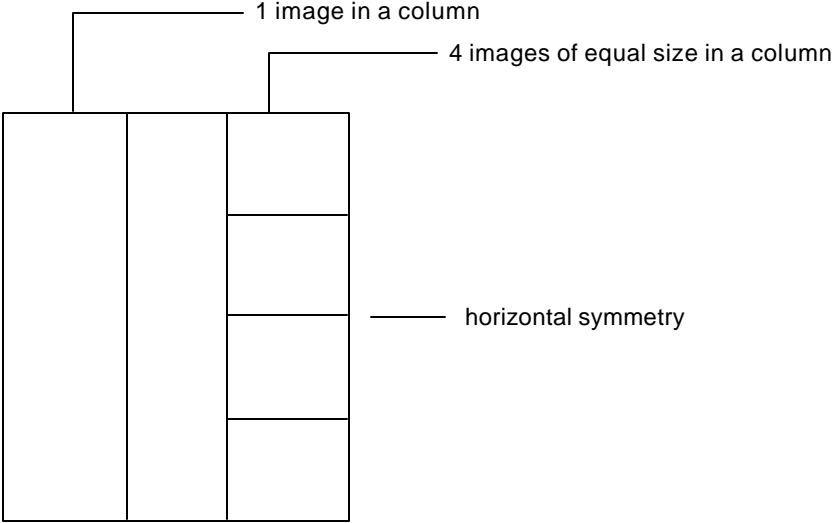

C.13.4 Basic Film Box Relationship Module

**Table C.13-4
BASIC FILM BOX RELATIONSHIP MODULE ATTRIBUTES**

Attribute Name	Tag	Attribute Description
Referenced Film Session Sequence	(2010,0500)	A sequence which provides references to a Film Session SOP Class/Instance pairs. Only a single Item shall be permitted in this Sequence.
>Referenced SOP Class UID	(0008,1150)	Uniquely identifies the referenced SOP Class.
>Referenced SOP Instance UID	(0008,1155)	Uniquely identifies the referenced SOP Instance.
Referenced Image Box Sequence	(2010,0510)	A sequence which provides references to a set of Image Box SOP Class/Instance pairs. One or more Items may be included in this Sequence.
>Referenced SOP Class UID	(0008,1150)	Uniquely identifies the referenced SOP Class.
>Referenced SOP Instance UID	(0008,1155)	Uniquely identifies the referenced SOP Instance.
Referenced Basic Annotation Box Sequence	(2010,0520)	A Sequence which provides references to a set of Basic Annotation Box SOP Class/Instance pairs. Zero or more Items may be included in this Sequence.
>Referenced SOP Class UID	(0008,1150)	Uniquely identifies the referenced SOP Class.
>Referenced SOP Instance UID	(0008,1155)	Uniquely identifies the referenced SOP Instance.
Referenced Presentation LUT Sequence	(2050,0500)	A sequence which provides references to a Presentation LUT related SOP Class/Instance pairs. Only a single Item shall be included in this sequence.
>Referenced SOP Class UID	(0008,1150)	Uniquely identifies the referenced SOP Class.
>Referenced SOP Instance UID	(0008,1155)	Uniquely identifies the referenced SOP Instance.

C.13.5 Image Box Pixel Presentation Module

**Table C.13-5
IMAGE BOX PIXEL PRESENTATION MODULE ATTRIBUTES**

Attribute Name	Tag	Attribute Description
Image Position	(2020,0010)	The position of the image on the film, based on Image Display Format (2010,0010). See C.13.5.1 for specification.
Polarity	(2020,0020)	Specifies whether minimum pixel values (after VOI LUT transformation) are to be printed black or white. Enumerated Values: NORMAL = pixels shall be printed as specified by the Photometric Interpretation (0028,0004) REVERSE = pixels shall be printed with the opposite polarity as specified by the Photometric Interpretation (0028,0004) If Polarity (2020,0020) is not specified by the SCU, the SCP shall print with NORMAL polarity.
Magnification Type	(2010,0060)	Description is the same as in Table C.13-3. Overrides the Magnification Type specified for the Film Box
Smoothing Type	(2010,0080)	Description is the same as in Table C.13-3. Overrides the Smoothing Type specified for the Film Box
Configuration Information	(2010,0150)	See Table C.13-3 for description of Configuration Information.
Requested Image Size	(2020,0030)	Width (x-dimension) in mm of the image to be printed. This value overrides the size that corresponds with optimal filling of the Image Box.
Requested Decimate/Crop Behavior	(2020,0040)	Specifies whether image pixels are to be decimated or cropped if the image rows or columns is greater than the available printable pixels in an Image Box. Decimation means that a magnification factor <1 is applied to the image. The method of decimation shall be that specified by Magnification Type (2010,0060) or the SCP default if not specified Cropping means that some image rows and/or columns are deleted before printing Enumerated Values: DECIMATE = a magnification factor <1 to be applied to the image. CROP = some image rows and/or columns are to be deleted before printing. The specific algorithm for cropping shall be described in the SCP Conformance Statement. FAIL = the SCP shall not crop or decimate

Basic Grayscale Image Sequence	(2020,0110)	A sequence which provides the content of the grayscale image pixel data to be printed. This is a specialization of the Image Pixel Module defined in C.7.6.3 of this part. It is encoded as a sequence of Attributes of the Image Pixel Module. Zero or one Item may be included in this Sequence. See PS 3.4 for further description.
>Samples Per Pixel	(0028,0002)	See C.7.6.3 for description of Image Pixel Module. Enumerated Value: 1
>Photometric Interpretation	(0028,0004)	See C.7.6.3 for description of Image Pixel Module. Enumerated Values: MONOCHROME1 MONOCHROME2
>Rows	(0028,0010)	See C.7.6.3 for description of Image Pixel Module
>Columns	(0028,0011)	See C.7.6.3 for description of Image Pixel Module
>Pixel Aspect Ratio	(0028,0034)	See C.7.6.3 for description of Image Pixel Module
>Bits Allocated	(0028,0100)	See C.7.6.3 for description of Image Pixel Module. Enumerated Values: 8 (if Bits Stored = 8) 16 (if Bits Stored = 12)
>Bits Stored	(0028,0101)	See C.7.6.3 for description of Image Pixel Module. Enumerated Values: 8 12
>High Bit	(0028,0102)	See C.7.6.3 for description of Image Pixel Module. Enumerated Values: 7 (if BITS STORED = 8) 11 (if BITS STORED = 12)
>Pixel Representation	(0028,0103)	See C.7.6.3 for description of Image Pixel Module. Enumerated Value: 0000H (unsigned integer)
>Pixel Data	(7FE0,0010)	See C.7.6.3 for description of Image Pixel Module
Basic Color Image Sequence	(2020,0111)	A sequence which provides the content of the color image pixel data to be printed. It is a specialization of the Image Pixel Module defined in C.7.6.3 of this part. It is encoded as a sequence of Attributes of the Image Pixel Module. Zero or one Item may be included in this Sequence. See PS 3.4 for further description.
>Samples Per Pixel	(0028,0002)	See C.7.6.3 for description of Image Pixel Module. Enumerated Value: 3

>Photometric Interpretation	(0028,0004)	See C.7.6.3 for description of Image Pixel Module. Enumerated Value: RGB
>Planar Configuration	(0028,0006)	See C.7.6.3 for description of Image Pixel Module. Enumerated Value: 0001H (frame interleave)
>Rows	(0028,0010)	See C.7.6.3 for description of Image Pixel Module.
>Columns	(0028,0011)	See C.7.6.3 for description of Image Pixel Module.
>Pixel Aspect Ratio	(0028,0034)	See C.7.6.3 for description of Image Pixel Module.
>Bits Allocated	(0028,0100)	See C.7.6.3 for description of Image Pixel Module. Enumerated Value: 8
>Bits Stored	(0028,0101)	See C.7.6.3 for description of Image Pixel Module. Enumerated Value: 8
>High Bit	(0028,0102)	See C.7.6.3 for description of Image Pixel Module. Enumerated Value: 7
>Pixel Representation	(0028,0103)	See C.7.6.3 for description of Image Pixel Module. Enumerated Value: 0000H (unsigned integer)
>Pixel Data	(7FE0,0010)	See C.7.6.3 for description of Image Pixel Module
Referenced Image Overlay Box Sequence	(2020,0130)	A sequence which provides references to an Image Overlay Box SOP Class/Instance pair and a specific frame number in multi-frame instances. Zero or one Item may be included in this Sequence.
>Referenced SOP Class UID	(0008,1150)	Uniquely identifies the referenced SOP Class.
>Referenced SOP Instance UID	(0008,1155)	Uniquely identifies the referenced SOP Instance.
Original Image Sequence	(2130,00C0)	Attributes of the original modality images to be printed in this Film Session.
>Study Instance UID	(0020,000D)	See C.7.2.1 for description.
>Series Instance UID	(0020,000E)	See C.7.3.1 for description.
>Patient ID	(0010,0020)	See C.7.1.1 for description.
>Referenced SOP Class UID	(0008,1150)	SOP Class UID of the original modality image used to create this Image Box.
>Referenced SOP Instance UID	(0008,1155)	SOP Instance UID of the original modality image used to create this Image Box.
>Referenced Frame Number	(0008,1160)	See C.7.6.1 for description.
>Instance Number	(0020,0013)	See C.7.6.1 for description.

C.13.5.1 Image Position

The position of the image on the film; the encoding of the image position sequence is based on the selected Image Display Format (2010,0010). The image position sequence shall be increasing order beginning with the value 1. Image Position (2020,0010) is defined as follows:

- STANDARD display format: image box sequence shall be major row order (from left-to-right and from top-to-bottom); top left image position shall be equal to 1.
- ROW display format: image box sequence shall be major row order (from left-to-right and from top-to-bottom); top left image position shall be set to 1.
- COL display format: image box sequence shall be major column order (from top-to-bottom and from left-to-right); top left image position shall be equal to 1.
- SLIDE display format: image box sequence shall be major row order (from left-to-right and from top-to-bottom); top left image position shall be set to 1.
- SUPERSLIDE display format: image box sequence shall be major row order (from left-to-right and from top-to-bottom); top left image position shall be set to 1.
- CUSTOM STANDARD display format: image box sequence shall be defined in the Conformance Statement; top left image position shall be set to 1.

C.13.6 Image Box Relationship Module (Retired)

This section was previously defined in DICOM. It is now retired. See PS 3.3-1998.

C.13.7 Basic Annotation Presentation Module

**Table C.13-7
BASIC ANNOTATION PRESENTATION MODULE ATTRIBUTES**

Attribute Name	Tag	Attribute Description
Annotation Position	(2030,0010)	The position of the annotation box in the parent film box. Annotation position sequence depends on the selected Annotation Display Format ID (2010,0030)
Text String	(2030,0020)	Text string

C.13.8 Print Job Module

**Table C.13-8
PRINT JOB MODULE ATTRIBUTES**

Attribute Name	Tag	Attribute Description
Execution Status	(2100,0020)	Execution status of print job. Enumerated Values: PENDING PRINTING DONE FAILURE

Execution Status Info	(2100,0030)	Additional information about Execution Status (2100,0020). Defined Terms when the Execution Status is DONE or PRINTING: NORMAL Defined Terms when the Execution Status is FAILURE: INVALID PAGE DES = The specified page layout cannot be printed or other page description errors have been detected. INSUFFIC MEMORY = There is not enough memory available to complete this job. See Section C.13.9.1 for additional Defined Terms when the Execution Status is PENDING or FAILURE.
Creation Date	(2100,0040)	Date of print job creation.
Creation Time	(2100,0050)	Time of print job creation.
Print Priority	(2000,0020)	Priority of print job (see C.13.1 for further explanation).
Printer Name	(2110,0030)	User defined name identifying the printer.
Originator	(2100,0070)	DICOM Application Entity Title that issued the print operation.

C.13.9 Printer Module

**Table C.13-9
PRINTER MODULE ATTRIBUTES**

Attribute Name	Tag	Attribute Description
Printer Status	(2110,0010)	Printer device status. Enumerated Values: NORMAL WARNING FAILURE
Printer Status Info	(2110,0020)	Additional information about Printer Status (2110,0010). Defined Terms when the Printer Status is equal to NORMAL: NORMAL See Section C.13.9.1 for Defined Terms when the Printer Status is equal to WARNING or FAILURE.
Printer Name	(2110,0030)	User defined name identifying the printer.
Manufacturer	(0008,0070)	Manufacturer of the printer.
Manufacturer Model Name	(0008,1090)	Manufacturer's model number of the printer.
Device Serial Number	(0018,1000)	Manufacturer's serial number of the printer.

Software Versions	(0018,1020)	Manufacturer's designation of software version of the printer.
Date Of Last Calibration	(0018,1200)	Date when the printer was last calibrated.
Time Of Last Calibration	(0018,1201)	Time when the printer was last calibrated.

C.13.9.1 Printer Status Info and Execution Status Info

Additional Defined Terms for Printer Status Info (2110,0020) and Execution Status Info (2100,0030) are:

BAD RECEIVE MGZ	There is a problem with the film receive magazine. Films from the printer cannot be transported into the magazine.
BAD SUPPLY MGZ	There is a problem with a film supply magazine. Films from this magazine cannot be transported into the printer.
CALIBRATING	Printer is performing self calibration, it is expected to be available for normal operation shortly.
CALIBRATION ERR	An error in the printer calibration has been detected, quality of processed films may not be optimal.
CHECK CHEMISTRY	A problem with the processor chemicals has been detected, quality of processed films may not be optimal.
CHECK SORTER	There is an error in the film sorter.
CHEMICALS EMPTY	There are no processing chemicals in the processor, films will not be printed and processed until the processor is back to normal.
CHEMICALS LOW	The chemical level in the processor is low, if not corrected, it will probably shut down soon.
COVER OPEN	One or more printer or processor covers, drawers, doors are open.
ELEC CONFIG ERR	Printer configured improperly for this job.
ELEC DOWN	Printer is not operating due to some unspecified electrical hardware problem.
ELEC SW ERROR	Printer not operating for some unspecified software error.
EMPTY 8X10	The 8x10 inch film supply magazine is empty.
EMPTY 8X10 BLUE	The 8x10 inch blue film supply magazine is empty.
EMPTY 8X10 CLR	The 8x10 inch clear film supply magazine is empty.
EMPTY 8X10 PAPER	The 8x10 inch paper supply magazine is empty.
EMPTY 10X12	The 10x12 inch film supply magazine is empty.
EMPTY 10X12 BLUE	The 10x12 inch blue film supply magazine is empty.
EMPTY 10X12 CLR	The 10x12 inch clear film supply magazine is empty.
EMPTY 10X12 PAPER	The 10x12 inch paper supply magazine is empty.
EMPTY 10X14	The 10x14 inch film supply magazine is empty.
EMPTY 10X14 BLUE	The 10x14 inch blue film supply magazine is empty.
EMPTY 10X14 CLR	The 10x14 inch clear film supply magazine is empty.

EMPTY 10X14 PAPR	The 10x14 inch paper supply magazine is empty.
EMPTY 11X14	The 11x14 inch film supply magazine is empty.
EMPTY 11X14 BLUE	The 11x14 inch blue film supply magazine is empty.
EMPTY 11X14 CLR	The 11x14 inch clear film supply magazine is empty.
EMPTY 11X14 PAPR	The 11x14 inch paper supply magazine is empty.
EMPTY 14X14	The 14x14 inch film supply magazine is empty.
EMPTY 14X14 BLUE	The 14x14 inch blue film supply magazine is empty.
EMPTY 14X14 CLR	The 14x14 inch clear film supply magazine is empty.
EMPTY 14X14 PAPR	The 14x14 inch paper supply magazine is empty.
EMPTY 14X17	The 14x17 inch film supply magazine is empty.
EMPTY 14X17 BLUE	The 14x17 inch blue film supply magazine is empty.
EMPTY 14X17 CLR	The 14x17 inch clear film supply magazine is empty.
EMPTY 14X17 PAPR	The 14x17 inch paper supply magazine is empty.
EMPTY 24X24	The 24x24 cm film supply magazine is empty.
EMPTY 24X24 BLUE	The 24x24 cm blue film supply magazine is empty.
EMPTY 24X24 CLR	The 24x24 cm clear film supply magazine is empty.
EMPTY 24X24 PAPR	The 24x24 cm paper supply magazine is empty.
EMPTY 24X30	The 24x30 cm film supply magazine is empty.
EMPTY 24X30 BLUE	The 24x30 cm blue film supply magazine is empty.
EMPTY 24X30 CLR	The 24x30 cm clear film supply magazine is empty.
EMPTY 24X30 PAPR	The 24x30 cm paper supply magazine is empty.
EMPTY A4 PAPR	The A4 paper supply magazine is empty.
EMPTY A4 TRANS	The A4 transparency supply magazine is empty.
EXPOSURE FAILURE	The exposure device has failed due to some unspecified reason.
FILM JAM	A film transport error has occurred and a film is jammed in the printer or processor.
FILM TRANSP ERR	There is a malfunction with the film transport, there may or may not be a film jam.
FINISHER EMPTY	The finisher is empty.
FINISHER ERROR	The finisher is not operating due to some unspecified reason.
FINISHER LOW	The finisher is low on supplies
LOW 8X10	The 8x10 inch film supply magazine is low.
LOW 8X10 BLUE	The 8x10 inch blue film supply magazine is on film.
LOW 8X10 CLR	The 8x10 inch clear film supply magazine is low.
LOW 8X10 PAPR	The 8x10 inch paper supply magazine is low.
LOW 10X12	The 10x12 inch film supply magazine is low.
LOW 10X12 BLUE	The 10x12 inch blue film supply magazine is low.

LOW 10X12 CLR	The 10x12 inch clear film supply magazine is low.
LOW 10X12 PAPER	The 10x12 inch paper supply magazine is low.
LOW 10X14	The 10x14 inch film supply magazine is low.
LOW 10X14 BLUE	The 10x14 inch blue film supply magazine is low.
LOW 10X14 CLR	The 10x14 inch clear film supply magazine is low.
LOW 10X14 PAPER	The 10x14 inch paper supply magazine is low.
LOW 11X14	The 11x14 inch film supply magazine is low.
LOW 11X14 BLUE	The 11x14 inch blue film supply magazine is low.
LOW 11X14 CLR	The 11x14 inch clear film supply magazine is low.
LOW 11X14 PAPER	The 11x14 inch paper supply magazine is low.
LOW 14X14	The 14x14 inch film supply magazine is low.
LOW 14X14 BLUE	The 14x14 inch blue film supply magazine is low.
LOW 14X14 CLR	The 14x14 inch clear film supply magazine is low.
LOW 14X14 PAPER	The 14x14 inch paper supply magazine is low.
LOW 14X17	The 14x17 inch film supply magazine is low.
LOW 14X17 BLUE	The 14x17 inch blue film supply magazine is low.
LOW 14X17 CLR	The 14x17 inch clear film supply magazine is low.
LOW 14X17 PAPER	The 14x17 inch paper supply magazine is low.
LOW 24X24	The 24x24 cm film supply magazine is low.
LOW 24X24 BLUE	The 24x24 cm blue film supply magazine is low.
LOW 24X24 CLR	The 24x24 cm clear film supply magazine is low.
LOW 24X24 PAPER	The 24x24 cm paper supply magazine is low.
LOW 24X30	The 24x30 cm film supply magazine is low.
LOW 24X30 BLUE	The 24x30 cm blue film supply magazine is low.
LOW 24X30 CLR	The 24x30 cm clear film supply magazine is low.
LOW 24X30 PAPER	The 24x30 cm paper supply magazine is low.
LOW A4 PAPER	The A4 paper supply magazine is low.
LOW A4 TRANS	The A4 transparency supply magazine is low.
NO RECEIVE MGZ	The film receive magazine not available
NO RIBBON	The ribbon cartridge needs to be replaced.
NO SUPPLY MGZ	The film supply magazine specified for this job is not available.
CHECK PRINTER	The printer is not ready at this time, operator intervention is required to make the printer available.
CHECK PROC	The processor is not ready at this time, operator intervention is required to make the printer available.
PRINTER DOWN	The printer is not operating due to some unspecified reason.

PRINTER BUSY	Printer is not available at this time, but should become ready without user intervention. This is to handle non-initialization instances.
PRINTER BUFFER FULL	The Printer 's buffer capacity is full. The printer is unable to accept new images in this state. The printer will correct this without user intervention. The SCU should retry later.
PRINTER INIT	The printer is not ready at this time, it is expected to become available without intervention. For example, it may be in a normal warm-up state.
PRINTER OFFLINE	The printer has been disabled by an operator or service person.
PROC DOWN	The processor is not operating due to some unspecified reason.
PROC INIT	The processor is not ready at this time, it is expected to become available without intervention. For example, it may be in a normal warm-up state.
PROC OVERFLOW FL	Processor chemicals are approaching the overflow full mark.
PROC OVERFLOW HI	Processor chemicals have reached the overflow full mark.
QUEUED	Print Job in Queue
RECEIVER FULL	The Film receive magazine is full.
REQ MED NOT INST	The requested film, paper, or other media supply magazine is installed in the printer, but may be available with operator intervention.
REQ MED NOT AVAI	The requested film, paper, or other media requested is not available on this printer.
RIBBON ERROR	There is an unspecified problem with the print ribbon.
SUPPLY EMPTY	The printer is out of film.
SUPPLY LOW	The film supply is low.
UNKNOWN	There is an unspecified problem.

C.13.10 Image Overlay Box Presentation Module (Retired)

This section was previously defined in DICOM. It is now retired. See PS 3.3-1998.

C.13.11 Image Overlay Box Relationship Module (Retired)

This section was previously defined in DICOM. It is now retired. See PS 3.3-1998.

C.13.12 Print Request Module

Table C.13-12 specifies the Attributes that identify the print request.

Table C.13-12
PRINT REQUEST MODULE ATTRIBUTES

Attribute Name	Tag	Description
Number of Copies	(2000,0010)	See C.13.1 for description.
Print Priority	(2000,0020)	See C.13.1 for description.
Medium Type	(2000,0030)	See C.13.1 for description.

Film Destination	(2000,0040)	See C.13.1 for description.
Film Session Label	(2000,0050)	See C.13.1 for description.
Memory Allocation	(2000,0060)	See C.13.1 for description.
Color Image Printing Flag	(2000,0062)	Flag describing how grayscale printers shall print color images. Enumerated Values : BESTFIT = attempt to print color image pixel data on a grayscale printer REJECT = do not attempt to print color image pixel data on a grayscale printer Meaningful only for grayscale printers
Collation Flag	(2000,0063)	Flag indicating that the films of the print request shall be collated. Enumerated Values : YES NO
Annotation Flag	(2000,0065)	Flag describing how printers that do not support Annotation Content Sequence (2130,0050) shall react if it is contained in the Stored Print IOD. Enumerated Values: BESTFIT = print images without Annotation REJECT = do not attempt to print images
Image Overlay Flag	(2000,0067)	Flag describing how printers that do not support Image Overlay Box Content Sequence (2130,0060) shall react if it is contained in the Stored Print IOD. Enumerated Values: BESTFIT = print images without the Overlay(s) REJECT = do not attempt to print images
Presentation LUT Flag	(2000,0069)	Flag describing how printers that do not support Presentation LUT Content Sequence (2130,0080) shall react if it is contained in the Stored Print IOD. Enumerated Values: BESTFIT = print images without a Presentation LUT REJECT = do not attempt to print images
Image Box Presentation LUT Flag	(2000,006A)	Flag describing how printers that do not support Presentation LUT Content Sequence (2130,0080) at the Image Box level shall react if a Presentation LUT is contained in Image Box Content Sequence (2130,0040). Enumerated Values: BESTFIT = print image with the Presentation LUT specified in Film Box Content Sequence (2130,0030). REJECT = do not attempt to print images
Configuration Information	(2010,0150)	See C.13.3 for description. Value overrides the corresponding attribute value in the referenced Stored Print Storage SOP Instance.
Illumination	(2010,015E)	See C.13.3 for description.

Reflected Ambient Light	(2010,0160)	See C.13.3 for description.
Owner ID	(2100,0160)	See C.13.1 for description.
Referenced Stored Print Sequence	(2000,0510)	Reference to Stored Print Storage SOP Instance. Sequence contains one or more items.
> Retrieve AE Title	(0008,0054)	Application Entity Title where the Stored Print Storage SOP Instance may be retrieved.
>Referenced SOP Class UID	(0008,1150)	Uniquely identifies the referenced SOP Class.
>Referenced SOP Instance UID	(0008,1155)	Uniquely identifies the referenced SOP Instance.
>Study Instance UID	(0020,000D)	Unique identifier for the Study.
>Series Instance UID	(0020,000E)	Unique identifier for the Series.
>Patient ID	(0010,0020)	Primary hospital identification number or code for the patient.

C.13.13 Printer Configuration Module

This Module describes Printer Configuration Information.

Table C.13-13
PRINTER CONFIGURATION MODULE

Attribute Name	Tag	Attribute Description
Printer Configuration Sequence	(2000,001E)	Contains printer configuration information for a single Application Entity title. See Print Management Service Class Structure in PS 3.4. The sequence shall contain one item for each physical printer/Meta SOP Class combination supported by the Application Entity title.
>SOP Classes Supported	(0008,115A)	The Meta-SOP Class and a list of optional SOP Classes supported. It shall contain one Meta SOP Class UID and 0-n optional SOP Class UIDs.
>Maximum Memory Allocation	(2000,0061)	Maximum number of kilobytes of memory that can be allocated for a Film Session. The value shall be 0 if Memory Allocation (2000,0060) is not supported.
>Memory Bit Depth	(2000,00A0)	The maximum number of bits for each pixel that can be stored in printer memory.
>Printing Bit Depth	(2000,00A1)	The number of bits used by the print engine for internal LUT calculation and printing of each pixel.
>Media Installed Sequence	(2000,00A2)	A sequence which specifies the combinations of Medium Type and Film Size IDs available in the printer at this time and the Min and Max Densities supported by these media. The Item Number with the value of 1 is the printer default. There is no significance to other item numbers. One item for each Medium Type and Film Size ID installed shall be included.

>>Item Number	(0020,0019)	A number that labels this item. Each item in the sequence shall have a unique number.
>>Medium Type	(2000,0030)	See C.13.1
>>Film Size ID	(2010,0050)	See C.13.3
>>Min Density	(2010,0120)	Minimum density that can be printed, expressed in hundredths of OD.
>>Max Density	(2010,0130)	Maximum density that can be printed, expressed in hundredths of OD.
>Other Media Available Sequence	(2000,00A4)	A sequence which specifies combinations of Medium Type and Film Size ID for which the printer will accept an N-CREATE of a Film Box, but are not physically installed in the printer at this time. It also specifies the Min and Max Densities supported by these media. User intervention may be required to instal these media in the printer. One item for each Medium Type and Film Size ID available, but not installed shall be included.
>>Medium Type	(2000,0030)	See C.13.1
>>Film Size ID	(2010,0050)	See C.13.3
>>Min Density	(2010,0120)	Minimum density that can be printed, expressed in hundredths of OD.
>>Max Density	(2010,0130)	Maximum density that can be printed, expressed in hundredths of OD.
>Supported Image Display Formats Sequence	(2000,00A8)	A sequence which specifies the Image Display Formats supported, rows and columns in Image Boxes for each format, pixel spacing, and whether Requested Image Size is supported as a function of Film Orientation, Film Size ID, and Printer Resolution ID. One item for each display format, film orientation, film size, and printer resolution combination shall be included.
>>Rows	(0028,0010)	Number of printable rows in an Image Box.
>>Columns	(0028,0011)	Number of printable columns in an Image Box
>>Image Display Format	(2010,0010)	See C.13.3
>>Film Orientation	(2010,0040)	See C.13.3
>>Film Size ID	(2010,0050)	See C.13.3
>>Printer Resolution ID	(2010,0052)	Printer Resolution identification. Defined Terms are the same as Requested Resolution ID (2020,0050). See C.13.3.
>>Printer Pixel Spacing	(2010,0376)	Physical distance on the printed film between the center of each pixel, specified by a numeric pair - adjacent row spacing (delimiter) adjacent column spacing in mm.

>>Requested Image Size Flag	(2020,00A0)	Indicates whether the printer supports Requested Image Size (2020,0030) for this display format and film orientation and size combination. Enumerated Values: NO = not supported YES = supported
>Default Printer Resolution ID	(2010,0054)	The printer's default resolution identification. Defined Terms are the same as Requested Resolution ID (2020,0050). See C.13.3.
>Default Magnification Type	(2010,00A6)	Printer's default magnification type. See C.13.3 for Defined Terms.
>Other Magnification Types Available	(2010,00A7)	Other magnification types available in the printer. See C.13.3 for Defined Terms.
>Default Smoothing Type	(2010,00A8)	Printer's default smoothing type. See C.13.3.
>Other Smoothing Types Available	(2010,00A9)	Other smoothing types available in the printer. See C.13.3.
>Configuration Information Description	(2010,0152)	A free form text description of Configuration Information (2010,0150) supported by the printer.
>Maximum Collated Films	(2010,0154)	The maximum number of films that can be collated for an N-ACTION of the Film Session. The value shall be 0 if N-ACTION of the Film Session is not supported.
>Decimate/Crop Result	(2020,00A2)	Indicates whether the printer will decimate or crop image pixels if the image rows or columns is greater than the available printable pixels in an Image Box. See C.13.5. Enumerated Values when the printer does not support Requested Decimate/Crop Behavior (2020,0040): DECIMATE = image will be decimated to fit. CROP = image will be cropped to fit. FAIL = N-SET of the Image Box will fail Enumerated Values when the printer supports Requested Decimate/Crop Behavior (2020,0040): DEF DECIMATE = image will be decimated to fit. DEF CROP = image will be cropped to fit DEF FAIL = N-SET of the Image Box will fail This value indicates the printer default if the SCU does not create or set Requested Decimate/Crop Behavior for the Image Box.

C.14 STORAGE COMMITMENT MODULE

Table C.14-1 defines the Attributes for referencing SOP Instances which are contained in a Storage Commitment Request/Response.

**Table C.14-1
STORAGE COMMITMENT MODULE ATTRIBUTES**

Attribute Name	Tag	Attribute Description
Transaction UID	(0008,1195)	Uniquely identifies this Storage Commitment transaction.
Retrieve AE Title	(0008,0054)	Application Entity Title where the SOP Instance(s) may be retrieved via a network based retrieve service.
Storage Media File-Set ID	(0088,0130)	User or implementation specific human readable identification of a Storage Media on which the SOP Instances reside.
Storage Media File-Set UID	(0088,0140)	Uniquely identifies a Storage Media on which the SOP Instances reside.
Referenced SOP Sequence	(0008,1199)	A sequence of repeating Items where each Item references a single SOP Instance for which storage commitment is requested / or has been provided.
>Referenced SOP Class UID	(0008,1150)	Uniquely identifies the referenced SOP Class.
>Referenced SOP Instance UID	(0008,1155)	Uniquely identifies the referenced SOP Instance.
>Retrieve AE Title	(0008,0054)	Application Entity Title from which the SOP Instance may be retrieved via a network based retrieve service.
>Storage Media File-Set ID	(0088,0130)	The user or implementation specific human readable identifier that identifies a Storage Media on which this SOP Instance resides.
>Storage Media File-Set UID	(0088,0140)	Uniquely identifies a Storage Media on which this SOP Instance resides.
Referenced Study Component Sequence	(0008,1111)	This Attribute identifies a Study Component to which all the SOP Instances for which Storage Commitment is requested belong. Only 1 SOP Class/Instance pair shall be present in this sequence.
>Referenced SOP Class UID	(0008,1150)	Uniquely identifies the referenced SOP Class.
>Referenced SOP Instance UID	(0008,1155)	Uniquely identifies the referenced SOP Instance.
Failed SOP Sequence	(0008,1198)	A sequence of repeating Items where each Item references a single SOP Instance for which storage commitment could not be provided.
>Referenced SOP Class UID	(0008,1150)	Uniquely identifies the referenced SOP Class.
>Referenced SOP Instance UID	(0008,1155)	Uniquely identifies the referenced SOP Instance.
>Failure Reason	(0008,1197)	The reason that storage commitment could not be provided for this SOP Instance. See Section C.14.1.1.

Note Conditions under which Attributes are required (i.e. Retrieve AE Title, etc.) are defined in the Storage Commitment Service Class in PS 3.4.

C.14.1 Study Commitment Attribute Description

C.14.1.1 Failure Reason

The following values and semantics shall be used for the Failure Reason Attribute :

- 0110H - Processing failure
A general failure in processing the operation was encountered.
- 0112H - No such object instance
One or more of the elements in the Referenced SOP Instance Sequence was not available.
- 0213H - Resource limitation
The SCP does not currently have enough resources to store the requested SOP Instance(s).
- 0122H - Referenced SOP Class not supported
Storage Commitment has been requested for a SOP Instance with a SOP Class that is not supported by the SCP.
- 0119H - Class / Instance conflict
The SOP Class of an element in the Referenced SOP Instance Sequence did not correspond to the SOP class registered for this SOP Instance at the SCP.
- 0131H - Duplicate transaction UID
The Transaction UID of the Storage Commitment Request is already in use.

C.15 QUEUE MANAGEMENT SPECIFIC MODULES**C.15.1 General Queue Module**

Table C.15-1
GENERAL QUEUE MODULE ATTRIBUTES

Attribute Name	Tag	Description
Queue Status	(2120,0010)	Status of the queue; Defined Terms: NORMAL = queue can accept new jobs FULL = queue is full, new jobs cannot be accepted, however existing jobs are being processed by the SCP HALTED = queue is halted (e.g. by a service person), new jobs cannot be accepted, existing jobs may or may not be processed and reprioritizing and deletion of jobs may or may not be accepted by the SCP

C.15.2 Print Queue Module

**Table C.15-2
PRINT GENERAL QUEUE MODULE ATTRIBUTES**

Attribute Name	Tag	Description
Print Job Description Sequence	(2120,0050)	<p>A list of Attributes describing each Print Job in the queue. Zero or more items shall be included in this sequence.</p> <p>Items in this sequence shall be listed in the following order:</p> <ul style="list-style-type: none"> Print Job now being printed Pending Print Jobs in the order in which they are expected to be printed Any Print Jobs which have failed and will not be printed Any Print Jobs which have been successfully competed <p>It is not a requirement that the SCP maintain a record and report failed and completed jobs. However, it may choose to maintain and report on these Print Jobs for some time after the Print Jobs have been completed or failed.</p>
>Print Job ID	(2100,0010)	Human readable identification of the Print Job. The ID shall be unique in the context of the Print Job Sequence.
>Execution Status	(2100,0020)	See Execution Status in Section C.13.8.
>Execution Status Info	(2100,0030)	See Execution Status Info in Section C.13.8.
>Creation Date	(2100,0040)	Date of print job creation.
>Creation Time	(2100,0050)	Time of print job creation.
>Print Priority	(2000,0020)	See Table C.13-1.
>Originator	(2100,0070)	Application Entity Title that issued the print job.
>Destination AE	(2100,0140)	Application Entity Title that performs the print job.
>Printer Name	(2110,0030)	User defined name identifying the printer.
>Film Destination	(2000,0040)	See Table C.13-1.
>Film Session Label	(2000,0050)	Human readable label that identifies the film session.
>Owner ID	(2100,0160)	Identification of the owner of the film session.
>Medium Type	(2000,0030)	See Table C.13-1.
>Number Of Films	(2100,0170)	Number of films in print job (= number of films in film session times number of copies).
>Referenced Print Job Sequence	(2120,0070)	A sequence which provides references to the corresponding Print Job SOP Class/Instance pair. Only a single Item shall be permitted in this sequence.

>>Referenced SOP Class UID	(0008,1150)	Uniquely identifies the Referenced SOP Class.
>>Referenced SOP Instance UID	(0008,1155)	Uniquely identifies the Referenced SOP Instance.

C.16 STORED PRINT SPECIFIC MODULES

The following Modules are used by the Stored Print IOD.

C.16.1 Printer Characteristics Module

Table C.16-1 specifies the Attributes that identify characteristics of a device that printed the Film Box.

**Table C.16-1
PRINTER CHARACTERISTICS MODULE ATTRIBUTES**

Attribute Name	Tag	Type	Description
Print Management Capabilities Sequence	(2130,0010)	1	A list of Print Management SOP Classes (e.g. Film Session SOP Class, Basic Annotation Box) and Image Storage SOP Classes (e.g. US Image, Hardcopy Grayscale Image) that the Stored Print IOD contains or refers to. One or more Items shall be included in this sequence.
>Referenced SOP Class UID	(0008,1150)	1	SOP Class UID of the SOP Class, that the Stored Print IOD contains or refers to.
Printer Characteristics Sequence	(2130,0015)	2	Printer Characteristics information. Only valid if film session/box has been printed. One Item shall be included in this sequence.
>Creation Date	(2100,0040)	3	Date of print job creation.
>Creation Time	(2100,0050)	3	Time of print job creation.
>Originator	(2100,0070)	2	Application Entity Title that issued the print operation.
>Destination AE	(2100,0140)	2	Application Entity Title that performed the print operation.
>Printer Name	(2110,0030)	3	User defined name identifying the printer.
>Manufacturer	(0008,0070)	3	Manufacturer of the printer.
>Manufacturer Model Name	(0008,1090)	3	Manufacturer's Model Name of the printer.
>Device Serial Number	(0018,1000)	3	Manufacturer's serial number of the printer.
>Software Version	(0018,1020)	3	Manufacturer's designation of software version of the printer.
>Date of Last Calibration	(0018,1200)	3	Date when the printer was last calibrated.
>Time of Last Calibration	(0018,1201)	3	Time when the printer was last calibrated.

C.16.2 Film Box Module

Table C.16-2 specifies the Attributes that identify characteristics of a Film Box.

**Table C.16-2
FILM BOX MODULE ATTRIBUTES**

Attribute Name	Tag	Type	Description
Instance Number	(0020,0013)	2	A number that identifies this film box.
Film Box Content Sequence	(2130,0030)	1	The content of the Film Box SOP Instance. One Item shall be included in this sequence.
>Image Display Format	(2010,0010)	1	See C.13.3 for description.
>Annotation Display Format ID	(2010,0030)	3	See C.13.3 for description.
>Film Orientation	(2010,0040)	2	See C.13.3 for description.
>Film Size ID	(2010,0050)	2	See C.13.3 for description.
>Magnification Type	(2010,0060)	2	See C.13.3 for description.
>Smoothing Type	(2010,0080)	3	See C.13.3 for description.
>Border Density	(2010,0100)	3	See C.13.3 for description.
>Empty Image Density	(2010,0110)	3	See C.13.3 for description.
>Min Density	(2010,0120)	3	See C.13.3 for description.
>Max Density	(2010,0130)	2	See C.13.3 for description.
>Trim	(2010,0140)	3	See C.13.3 for description.
>Configuration Information	(2010,0150)	2	See C.13.3 for description.
>Illumination	(2010,015E)	2C	See C.13.3 for description. Required if Presentation SOP Class is present.
>Reflected Ambient Light	(2010,0160)	2C	See C.13.3 for description. Required if Presentation SOP Class is present.
>Requested Resolution ID	(2020,0050)	3	See C.13.3
>Referenced Presentation LUT Sequence	(2050,0500)	1C	Reference to a LUT Instance UID contained in this IOD in Presentation LUT Content Sequence (2130,0080). The referenced LUT is to be applied to all images on this film, unless overridden by another reference contained in Image Box Content Sequence (2130,0040). If included, this sequence shall contain a single item. Required if a Presentation LUT is to be applied to the image.
>>Referenced SOP Instance UID	(0008,1155)	1C	Uniquely identifies the referenced SOP Instance; Required if Referenced Presentation LUT Sequence is present.

C.16.3 Image Box List Module

**Table C.16-3
IMAGE BOX LIST MODULE ATTRIBUTES**

Attribute Name	Tag	Type	Description
Image Box Content Sequence	(2130,0040)	1	The content of the Image Box SOP Instance. One or more Items shall be included in this sequence.
>SOP Instance UID	(0008,0018)	1C	SOP Instance UID of the contained Image Box SOP Class. Required if Sequence is sent
>Image Position	(2020,0010)	1	See C.13.5 for description.
>Polarity	(2020,0020)	2	See C.13.5 for description.
>Magnification Type	(2010,0060)	3	See C.13.5 for description.
>Configuration Information	(2010,0150)	3	See C.13.3 for description. The This value overrides any Configuration Information in Film Box Content Sequence (2130,0030)
>Smoothing Type	(2010,0080)	3	See C.13.5 for description.
>Requested Image Size	(2020,0030)	3	See C.13.5 for description.
>Requested Decimate/Crop Behavior	(2020,0040)	3	See C.13.5
>Referenced Image Sequence	(0008,1140)	1	A Sequence which provides references to an Image SOP Class/Instance pair and a specific frame in multi-frame instances. Only a single item shall be permitted in this Sequence.
>>Retrieve AE Title	(0008,0054)	1	Application Entity Title where the Image Storage SOP Instance may be retrieved
>>Referenced SOP Class UID	(0008,1150)	1	Uniquely identifies the referenced SOP Class.
>>Referenced SOP Instance UID	(0008,1155)	1	Uniquely identifies the referenced SOP Instance.
>>Study Instance UID	(0020,000D)	1	Unique identifier for the Study
>>Series Instance UID	(0020,000E)	1	Unique identifier for the Series
>>Referenced Frame Number	(0008,1160)	1C	Identifies the frame in the referenced multi-frame image referenced by this Image Sequence. Frame Number shall be increasing sequential order beginning with the value 1. Required if a Multi-frame Image is being referenced.
>>Patient ID	(0010,0020)	2	Primary hospital identification number or code for the patient

>Referenced Image Overlay Box Sequence	(2020,0130)	1C	Reference to an Overlay Instance UID contained in this IOD in Image Overlay Box Content Sequence (2130,0060). If included, this sequence shall contain a single item. Required if Image Overlay Box Content Sequence (2130,0060) is present.
>>Referenced SOP Instance UID	(0008,1155)	1C	Uniquely identifies the Referenced SOP Instance. Required if Referenced Image Overlay Box Sequence is sent.
>Referenced Presentation LUT Sequence	(2050,0500)	1C	Reference to a LUT Instance UID contained in this IOD in Presentation LUT Content Sequence (2130,0080). The referenced LUT overrides any LUT Instance contained in Film Box Content Sequence (2130,0030) If included, this sequence shall contain a single item. Required if a Presentation LUT which is different than any specified for the Film Box is to be applied to the image.
>>Referenced SOP Instance UID	(0008,1155)	1C	Uniquely identifies the referenced SOP Instance; Required if Referenced Presentation LUT Sequence is present.

C.16.4 Annotation List Module

**Table C.16-4
ANNOTATION LIST MODULE ATTRIBUTES**

Attribute Name	Tag	Type	Description
Annotation Content Sequence	(2130,0050)	3	The content of the Annotation SOP Instance. Zero or more Items shall be included in this sequence.
>SOP Instance UID	(0008,0018)	1C	SOP Instance UID of the contained Annotation SOP Class. Required if Sequence is sent.
>Annotation Position	(2030,0010)	1C	See C.13.7 for description. Required if the Annotation Content Sequence is sent.
>Text String	(2030,0020)	1C	See C.13.7 for description. Required if the Annotation Content Sequence is sent.

C.16.5 Image Overlay Box List Module

**Table C.16-5
IMAGE OVERLAY BOX LIST MODULE ATTRIBUTES**

Attribute Name	Tag	Type	Description
Image Overlay Box Content Sequence	(2130,0060)	3	The content of the Image Overlay Box SOP Instance. If sent, one or more Items shall be included in this sequence.
>SOP Instance UID	(0008,0018)	1C	SOP Instance UID of the contained Image Overlay Box SOP Class. Required if Sequence is sent.
>Overlay Pixel Data Sequence	(2040,0020)	1C	A sequence which provides overlay pixel data. A single item shall be present. Required if Sequence is sent.
>>Overlay Rows	(6000,0010)	1C	See C.9.2 Required if Sequence is sent.
>>Overlay Columns	(6000,0011)	1C	See C.9.2 Required if Sequence is sent.
>>Overlay Origin	(6000,0050)	1C	See C.9.2 Required if Sequence is sent.
>>Overlay Bits Allocated	(6000,0100)	1C	See C.9.5. Required if Sequence is sent.
>>Overlay Bit Position	(6000,0102)	1C	See C. 9.5. Required if Sequence is sent.
>>Overlay Data	(6000,3000)	1C	See C. 9.5. Required if Sequence is sent.
>Overlay or Image Magnification	(2040,0072)	1C	See C. 9.5. Required if Magnify to Number of Columns (2040,0074) is present.
>Magnify to Number of Columns	(2040,0074)	1C	See C. 9.5. Required if Overlay or Image Magnification (2040,0072) is present.
>Overlay Magnification Type	(2040,0060)	3	See C.9.5.
>Overlay Smoothing Type	(2040,0070)	3	See C.9.5.
>Overlay Foreground Density	(2040,0080)	3	See C.9.5.
>Overlay Background Density	(2040,0082)	3	See C.9.5.

Referenced Overlay Plane Sequence (2040,0010), Referenced SOP Class UID (0008,1150), Referenced SOP Instance UID (0008,1155), Referenced Frame Number (0008,1160), Referenced Overlay Plane Groups (2040,0011), Overlay Mode (2040,0090), and Threshold Density (2040,0100) were previously Attributes in this Module. They have been retired from this Module. See PS 3.3-1998.

C.16.6 Presentation LUT List Module

**Table C.16-6
PRESENTATION LUT LIST MODULE ATTRIBUTES**

Attribute Name	Tag	Type	Description
Presentation LUT Content Sequence	(2130,0080)	3	The content of the Presentation LUT SOP Instance. If sent, one or more Items shall be included in this sequence.
>SOP Instance UID	(0008,0018)	1C	SOP Instance UID of the contained Presentation LUT SOP Class. Required if Sequence is sent
>Presentation LUT Sequence	(2050,0010)	1C	See C.11.4 for description; Required if Presentation LUT Shape (2050,0020) is not present. Not allowed otherwise.
>>LUT Descriptor	(0028,3002)	1C	See C.11.4 for description; Required if Presentation LUT Sequence is sent.
>>LUT Explanation	(0028,3003)	3	See C.11.4 for description;
>>LUT Data	(0028,3006)	1C	See C.11.4 for description; Required if Presentation LUT Sequence is sent.
>Presentation LUT Shape	(2050,0020)	1C	See C.11.4 for description; Required if Presentation LUT Sequence (2050,0010) is not present. Not allowed otherwise. SCPs shall support the Enumerated Values IDENTITY and LIN OD

C.17 SR DOCUMENT MODULES

C.17.1 SR Document Series Module

Table C.17-1 defines the Attributes of the SR Document Series. A Series of SR Documents may contain any number of SR Documents.

Note: Series of SR Documents are separate from Series of Images or other Composite SOP Instances. SR Documents do not reside in a Series of Images or other Composite SOP Instances.

**Table C.17-1
SR DOCUMENT SERIES MODULE ATTRIBUTES**

Attribute Name	Tag	Type	Attribute Description
Modality	(0008,0060)	1	Modality type. Enumerated Value: SR = SR Document
Series Instance UID	(0020,000E)	1	Unique identifier of the Series. Note: No SR-specific semantics are specified.
Series Number	(0020,0011)	1	A number that identifies the Series. Note: No SR-specific semantics are specified.

Referenced Study Component Sequence	(0008,1111)	2	Uniquely identifies the Performed Procedure Step SOP Instance for which the Series is created. Only a single Item shall be permitted in this sequence. Notes: 1. The Study Component referred to by this Attribute is the Performed Procedure Step during which this Document is generated. 2. If this Document is generated during the same Modality Performed Procedure Step as the evidence in the current interpretation procedure, this attribute may contain reference to that Modality Performed Procedure Step. 3. This Attribute is not used to convey reference to the evidence in the current interpretation procedure. See Current Requested Procedure Evidence Sequence (0040,A375). 4. This Sequence may be sent zero length if the Performed Procedure Step is unknown.
>Referenced SOP Class UID	(0008,1150)	1C	Uniquely identifies the referenced SOP Class. Required if Referenced Study Component Sequence (0008,1111) is sent.
> Referenced SOP Instance UID	(0008,1155)	1C	Uniquely identifies the referenced SOP Instance. Required if Referenced Study Component Sequence (0008,1111) is sent.

C.17.2 SR DOCUMENT GENERAL MODULE

Table C.17-2 defines the general Attributes of an SR Document Instance. These Attributes identify the SR Document and provide context for the entire document.

**Table C.17-2
SR DOCUMENT GENERAL MODULE ATTRIBUTES**

Attribute Name	Tag	Type	Attribute Description
Instance Number	(0020,0013)	1	A number that identifies the SR Document.
Completion Flag	(0040,A491)	1	The estimated degree of completeness of this SR Document with respect to externally defined criteria in a manner specified in the Conformance Statement. Note: It may be desirable to make these criteria adaptable to local policies or user decisions. Enumerated Values: PARTIAL = Partial content. COMPLETE = Complete content.
Completion Flag Description	(0040,A492)	3	Explanation of the value sent in Completion Flag (0040,A491).
Verification Flag	(0040,A493)	1	Indicates whether this SR Document is Verified. Enumerated Values: UNVERIFIED = Not attested to. VERIFIED = Attested to by a Verifying Observer Name (0040,A075) who is accountable for its content. Note: The intent of this specification is that the "prevailing final version" of an SR Document is the version having the most recent Verification DateTime (0040,A030), Completion Flag (0040,A491) of COMPLETE and Verification Flag (0040,A493) of VERIFIED.
Content Date	(0008,0023)	1	The date the document content creation started.
Content Time	(0008,0033)	1	The time the document content creation started.
Verifying Observer Sequence	(0040,A073)	1C	The person or persons authorized to verify documents of this type and accept responsibility for the content of this document. One or more Items may be included in this sequence. Required if Verification Flag (0040,A493) is VERIFIED.
>Verifying Observer Name	(0040,A075)	1	The person authorized by the Verifying Organization (0040,A027) to verify documents of this type and who accepts responsibility for the content of this document
>Verifying Observer Identification Code Sequence	(0040,A088)	2	Coded identifier of Verifying Observer. Zero or one Items shall be permitted in this sequence.

<i>>>Include 'Code Sequence Macro' Table 8.8-1</i>			
>Verifying Organization	(0040,A027)	1	Organization to which the Verifying Observer Name (0040,A075) is accountable for this document in the current interpretation procedure.
>Verification DateTime	(0040,A030)	1	Date and Time of verification by the Verifying Observer Name (0040,A075).
Predecessor Documents Sequence	(0040,A360)	1C	<p>Shall refer to SR SOP Instances (e.g. prior or provisional reports) whose content has been wholly or partially included in this document with or without modification. One or more Items may be included in this sequence.</p> <p>Required if this document includes content from other documents.</p> <p>Note: The amendment process of an existing SR Document is not explicitly described, but several approaches may be considered. One may choose, for example, to create a new SR Document that includes the original content with any amendments applied or included. The structure of this amended SR Document may or may not reflect what was amended. However, the use of the Predecessor Document Sequence allows tracing back to the input SR Document, which in this case is the previous version.</p>
<i>>Include 'SOP Instance Reference Macro' Table C.17-3</i>			
Identical Documents Sequence	(0040,A525)	1C	<p>Duplicates of this document, stored with different SOP Instance UIDs. One or more Items may be included in this sequence.</p> <p>Required if this document is stored with different SOP Instance UIDs in one or more other Studies.</p> <p>See C.17.2.2 for further explanation.</p>
<i>>Include 'SOP Instance Reference Macro' Table C.17-3</i>			
Referenced Request Sequence	(0040,A370)	1C	<p>Identifies Requested Procedures which are being fulfilled (completely or partially) by creation of this Document. One or more Items may be included in this sequence.</p> <p>Required if this Document fulfills at least one Requested Procedure.</p>
>Study Instance UID	(0020,000D)	1	Unique identifier for the Study.
>Referenced Study Sequence	(0008,1110)	2	Uniquely identifies the Study SOP Instance. Only a single Item shall be permitted in this sequence.

>>Referenced SOP Class UID	(0008,1150)	1	Uniquely identifies the SOP Class
>>Referenced SOP Instance UID	(0008,1155)	1	Uniquely identifies the SOP Instance.
>Accession Number	(0008,0050)	2	A departmental IS generated number which identifies the order for the Study.
>Placer Order Number/Imaging Service Request	(0040,2016)	2	The order number assigned to the Imaging Service Request by the party placing the order.
>Filler Order Number/Imaging Service Request	(0040,2017)	2	The order number assigned to the Imaging Service Request by the party filling the order.
>Requested Procedure ID	(0040,1001)	2	Identifier of the related Requested Procedure
>Requested Procedure Description	(0032,1060)	2	Institution-generated administrative description or classification of Requested Procedure.
>Requested Procedure Code Sequence	(0032,1064)	2	A sequence that conveys the requested procedure. Zero or one Item may be included in this sequence.
>>Include 'Code Sequence Macro' Table 8.8-1		No Baseline Context ID Number is specified.	
Performed Procedure Code Sequence	(0040,A372)	2	A Sequence that conveys the codes of the performed procedures pertaining to this SOP Instance. Zero or more Items may be included in this sequence.
>Include 'Code Sequence Macro' Table 8.8-1		No Baseline Context ID Number is specified.	
Current Requested Procedure Evidence Sequence	(0040,A375)	1C	Full set of Composite SOP Instances created to satisfy the current Requested Procedure(s) for which this SR Document is generated. One or more Items may be included in this sequence. Required if Composite Objects were acquired in order to satisfy the Requested Procedure(s) for which the SR Document is generated. See C.17.2.3 for further explanation.
>Include 'SOP Instance Reference Macro' Table C.17-3			
Pertinent Other Evidence Sequence	(0040,A385)	1C	Other Composite SOP Instances that are considered to be pertinent evidence by the creator of this SR Document. This evidence must have been acquired in order to satisfy Requested Procedures other than the one(s) for which this SR Document is generated. One or more Items may be included in this sequence. Required if pertinent evidence from other Requested Procedures needs to be recorded. See C.17.2.3 for further explanation.
>Include 'SOP Instance Reference Macro' Table C.17-3			

C.17.2.1 SOP Instance Reference Macro

Table C.17-3 specifies the Attributes that reference a SOP Instance.

Table C.17-3
SOP INSTANCE REFERENCE MACRO ATTRIBUTES

Attribute Name	Tag	Type	Attribute Description
Study Instance UID	(0020,000D)	1	Unique identifier for the Study
Referenced Series Sequence	(0008,1115)	1	Sequence of Repeating Items where each Item includes the Attributes of a Series containing referenced Composite Object(s). One or more Items may be included in this sequence
>Series Instance UID	(0020,000E)	1	Unique identifier of a Series that is part of this Study and contains the referenced Composite Object(s).
>Retrieve AE Title	(0008,0054)	3	Title of the DICOM Application Entity where the Composite Object(s) may be retrieved on the network.
>Storage Media File-Set ID	(0088,0130)	3	The user or implementation specific human readable identifier that identifies the Storage Media on which the Composite Object (s) reside.
>Storage Media File-Set UID	(0088,0140)	3	Uniquely identifies the Storage Media on which the Composite Object (s) reside.
>Referenced SOP Sequence	(0008,1199)	1	References to Composite Object SOP Class/SOP Instance pairs that are part of the Study defined by Study Instance UID and the Series defined by Series Instance UID (0020,000E). One or more Items may be included in this sequence
>>Referenced SOP Class UID	(0008,1150)	1	Uniquely identifies the referenced SOP Class.
>>Referenced SOP Instance UID	(0008,1155)	1	Uniquely identifies the referenced SOP Instance.

C.17.2.2 Identical Documents Sequence

If identical copies of an SR Document are to be included in multiple Studies then the entire SR Document shall be duplicated with appropriate changes for inclusion into the different Studies (i.e. Study Instance UID, Series Instance UID, SOP Instance UID, Identical Documents Sequence etc.). The Identical Documents Sequence Attribute in each SOP Instance shall contain references to all other duplicate SOP Instances.

Note: If an SR Document contains an Identical Documents Sequence then it will not be further duplicated without producing a new complete set of duplicate SOP Instances with re-generated Identical Documents Sequences. This is a consequence of the rules for modification of SR Document content in PS3.4. For example, if there are two identical reports and an application is creating a third identical report, then the first two reports must be re-generated in order that their Identical Documents Sequence will reference the new duplicate document and all other identical documents.

If a new SR Document is created using content from an SR Document that contains an Identical Documents Sequence and is part of the same Requested Procedure, then the new SR Document shall only contain a new Identical Documents Sequence if the new SR Document is duplicated. The Predecessor Documents Sequence in all the new SR Documents shall contain references to the original SR Document and all its duplicates as well as any other documents from which content is included.

Note: It is up to an implementation to decide whether a new SR Document is duplicated across multiple Studies. This may require user input to make the decision.

C.17.2.3 Current Requested Procedure Evidence Sequence and Pertinent Other Evidence Sequence

The intent of the Current Requested Procedure Evidence Sequence is to reference all evidence created in order to satisfy the current Requested Procedure(s) for this SR Document. This shall include, but is not limited to, all current evidence referenced in the content tree.

The Pertinent Other Evidence Sequence attribute is used to reference all other evidence considered pertinent for this SR Document that is not listed in the Current Requested Procedure Evidence Sequence.

This requires that the same SOP Instance shall not be referenced in both of these Sequences.

C.17.3 SR Document Content Module

This section specifies the Attributes contained in the SR Document Content Module. The Attributes in this Module convey the content of an SR Document.

The Module consists of a single root Content Item that is the root of the SR Document tree. The root Content Item is of type CONTAINER, and its Content Sequence conveys either directly or indirectly through further nested Content Sequences, all of the other Content Items in the document. This root Content Item shall have a heading in the Concept Name Code Sequence (0040,A043) that conveys the title of the SR Document, i.e. the Document Title.

Figure C.17.3-1 depicts the relationship of SR Documents to Content Items and the relationships of Content Items to other Content Items and to Observation Context.

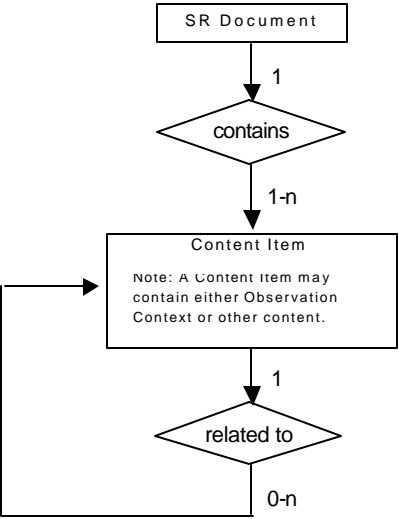

Figure C.17.3-1
SR Information Model

The value of the name/value pair is encoded with one of the Value Types defined in Table C.17.3-1 (the choice of which may be constrained by the IOD in which this Module is contained).

Content Items are identified by their position in the Content Item tree. They have an implicit order as defined by the order of the Sequence Items. See the definition of Referenced Content Item Identifier (0040,DB73). Table C.17.3-1 describes Value Types defined for Content Items.

**Table C.17.3-1
VALUE TYPE DEFINITIONS**

Value Type	Concept Name	Concept Value	Description
TEXT	Type of text, e.g. "Findings"	Textual expression of the concept	Free text, narrative description of unlimited length.
NUM	Type of numeric value or measurement, e.g. "BPD"	Numeric value and associated Unit of Measurement	Numeric value fully qualified by coded representation of the measurement name and unit of measurement.
CODE	Type of code, e.g. "Findings"	Coded expression of the concept	Categorical coded value. Representation of nominal or non-numeric ordinal values.
DATETIME	Type of DateTime, e.g. "Date/Time of onset"	Concatenated date and time	Date and time of occurrence of the type of event denoted by the Concept Name.
DATE	Type of Date, e.g. "Birth Date"	Calendar date	Date of occurrence of the type of event denoted by the Concept Name.
TIME	Type of Time, e.g. "Start Time"	Time of day	Time of occurrence of the type of event denoted by the Concept Name.
UIDREF	Type of UID, e.g. "Study Instance UID"	Unique Identifier	Unique Identifier (UID) of the entity identified by the Concept Name.
PNAME	Role of person, e.g., "Recording Observer"	Name of person	Person name of the person whose role is described by the Concept Name.
COMPOSITE	Purpose of Reference	Reference to UIDs of Composite SOP Instances	A reference to one Composite SOP Instance which is not an Image or Waveform.
IMAGE	Purpose of Reference	Reference to UIDs of Image Composite SOP Instances	A reference to one Image. IMAGE Content Item may convey a reference to a Softcopy Presentation State associated with the Image.
WAVEFORM	Purpose of Reference	Reference to UIDs of Waveform Composite SOP Instances	A reference to one Waveform.
SCoord	Purpose of Reference	Listing of spatial coordinates	Spatial coordinates of a geometric region of interest in the DICOM image coordinate system. The IMAGE Content Item from which spatial coordinates are selected is denoted by a SELECTED FROM relationship.

TCOORD	Purpose of Reference	Listing of temporal coordinates	Temporal Coordinates (i.e. time or event-based coordinates) of a region of interest in the DICOM waveform coordinate system. The WAVEFORM or IMAGE or SCOORD Content Item from which Temporal Coordinates are selected is denoted by a SELECTED FROM relationship.
CONTAINER	Document Title or document section heading. Concept Name conveys the Document Title (if the CONTAINER is the Document Root Content Item) or the category of observation.	The content of the CONTAINER. The value of a CONTAINER Content Item is the collection of Content Items that it contains.	CONTAINER groups Content Items and defines the heading or category of observation that applies to that content. The heading describes the content of the CONTAINER Content Item and may map to a document section heading in a printed or displayed document.

Note: It is recommended that drawings and sketches, sometimes used in reports, be represented by: IMAGE Content Items (8-bit, MONOCHROME2, Secondary Capture) or COMPOSITE Content Items (Stand-Alone Overlay).

Table C.17.3-2 describes the Relationship Types between Source Content Items and the Target Content Items.

Table C.17.3-2
RELATIONSHIP TYPE DEFINITIONS

Relationship Type	Description	Definition and Example
CONTAINS	Contains	Source Item contains Target Content Item. E.g.: CONTAINER "History" {CONTAINS: TEXT: "mother had breast cancer"; CONTAINS IMAGE 36}
HAS OBS CONTEXT	Has Observation Context	Target Content Items shall convey any specialization of Observation Context needed for unambiguous documentation of the Source Content Item. E.g: CONTAINER: "Report" {HAS OBS CONTEXT: PNAME: "Recording Observer" = "Smith^John^Dr^"}
HAS CONCEPT MOD	Has Concept Modifier	Used to qualify or describe the Concept Name of the Source Content item, such as to create a post-coordinated description of a concept, or to further describe a concept. E.g. CODE "Chest X-Ray" {HAS CONCEPT MOD: CODE "View = PA and Lateral"} E.g. CODE "Breast" {HAS CONCEPT MOD: TEXT "French Translation" = "Sein"} E.g. CODE "2VCXRPALAT" {HAS CONCEPT MOD: TEXT "Further Explanation" = "Chest X-ray, Two Views, Postero-anterior and Lateral"}

HAS PROPERTIES	Has Properties	Description of properties of the Source Content Item. E.g: CODE "Mass" {HAS PROPERTIES: CODE "anatomic location", HAS PROPERTIES: CODE "diameter", HAS PROPERTIES: CODE "margin", ...}.
HAS ACQ CONTEXT	Has Acquisition Context	The Target Content Item describes the conditions present during data acquisition of the Source Content Item. E.g: IMAGE 36 {HAS ACQ CONTEXT: CODE "contrast agent", HAS ACQ CONTEXT: CODE "position of imaging subject", ...}.
INFERRED FROM	Inferred From	Source Content Item conveys a measurement or other inference made from the Target Content Items. Denotes the supporting evidence for a measurement or judgment. E.g: CODE "Malignancy" {INFERRED FROM: CODE "Mass", INFERRED FROM: CODE "Lymphadenopathy",...}. E.g: NUM: "BPD = 5mm" {INFERRED FROM: SCOORD}.
SELECTED FROM	Selected From	Source Content Item conveys spatial or temporal coordinates selected from the Target Content Item(s). E.g: SCOORD: "CLOSED 1,1 5,10" {SELECTED FROM: IMAGE 36}. E.g: TCOORD: "SEGMENT 60-200mS" {SELECTED FROM: WAVEFORM}.

Table C.17.3-3
SR DOCUMENT CONTENT MODULE ATTRIBUTES

Attribute Name	Tag	Type	Attribute Description
<i>Include Document Relationship Macro Table C.17.3-4.</i>			
<i>Include Document Content Macro Table C.17.3-5. with a Value Type (0040,A040) of CONTAINER</i>			

**Table C.17.3-4
DOCUMENT RELATIONSHIP MACRO ATTRIBUTES**

Attribute Name	Tag	Type	Attribute Description
Observation DateTime	(0040,A032)	1C	<p>The date and time on which this Content Item was completed.</p> <p>Required if the date and time are different from the Content Date (0008,0023) and Content Time (0008,0033) or the Observation DateTime (0040,A032) defined in higher items.</p> <p>Note: When Content Items are copied into successor reports, the Content Date (0008,0023) and Content Time (0008,0033) of the new report are likely to be different than the date and time of the original observation. Therefore this attribute may need to be included in any copied Content Items to satisfy the condition.</p>
Content Template Sequence	(0040,A504)	1C	<p>Template that describes the content of this Content Item.</p> <p>Only a single Item shall be permitted in this sequence.</p> <p>Required if a template was used to define the content of this Item, and the template consists of a single CONTAINER with nested content, and it is the outermost invocation of a set of nested templates that start with the same CONTAINER.</p>
>Include 'Template Identification Macro' Table 9-1		No Baseline Template ID is defined.	

Content Sequence	(0040,A730)	1C	<p>A potentially recursively nested Sequence of Items that conveys content that is the Target of Relationships with the enclosing Source Content Item.</p> <p>One or more Items may be included in this sequence.</p> <p>Required if the enclosing Content Item has relationships.</p> <p>Notes: 1. If this Attribute is not present then the enclosing Item is a leaf. 2. The order of Items within this Sequence is semantically significant for presentation.</p>
>Relationship Type	(0040,A010)	1	<p>The type of relationship between the (enclosing) Source Content Item and the Target Content Item.</p> <p>IODs specify additional constraints on Relationships (including lists of Enumerated Values).</p> <p>Defined Terms:</p> <p>CONTAINS HAS PROPERTIES HAS OBS CONTEXT HAS ACQ CONTEXT INFERRED FROM SELECTED FROM HAS CONCEPT MOD</p>
<p><i>>Include Document Relationship Macro Table C.17.3-4 if the Target Content Item is included by-value in the Source Content Item. The Macro shall not be present if the relationship is by-reference.</i></p>			<p><i>>Include Document Content Macro Table C.17.3-5 if the Target Content Item is included by-value in the Source Content Item. The Macro shall not be present if the relationship is by-reference.</i></p>

<p>>Referenced Content Item Identifier</p>	<p>(0040,DB73)</p>	<p>1C</p>	<p>An ordered set of one or more integers that uniquely identifies the Target Content Item of the relationship.</p> <p>The root Content Item is referenced by a single value of 1.</p> <p>Each subsequent integer represents an ordinal position of a Content Item in the Content Sequence (0040,A730) in which it belongs. The Referenced Content Item Identifier is the set of these ordinal positions along the by-value relationship path. The number of values in this Multi-Value Attribute is exactly the number of relationships traversed in the SR content tree plus one.</p> <p>Note: 1. See example in note below table. 2. Content Items are ordered in a Content Sequence starting from 1 as defined in VR of SQ (See PS 3.5).</p> <p>Required if the Target Content Item is denoted by-reference, i.e. the Document Relationship Macro and Document Content Macro are not included.</p> <p>Shall not be present if Relationship Type (0040.A010) is CONTAINS.</p>
---	--------------------	-----------	--

Note: This example illustrates an SR content tree and identifiers associated with each Content Item:

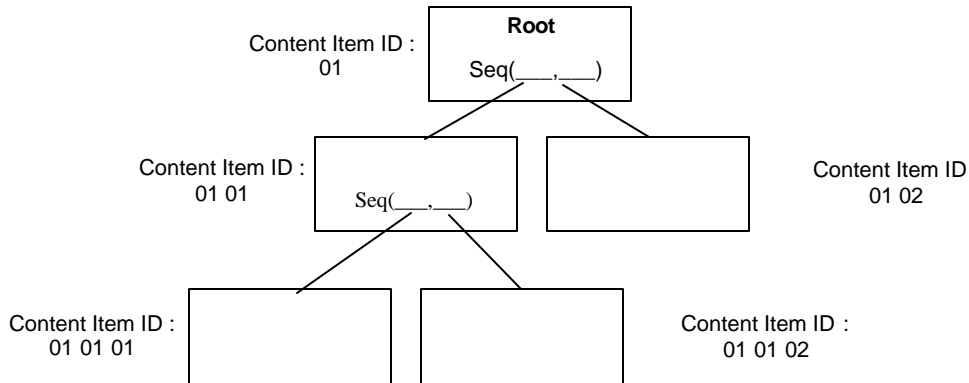

**Table C.17.3-5
DOCUMENT CONTENT MACRO ATTRIBUTES**

Attribute Name	Tag	Type	Attribute Description
Value Type	(0040,A040)	1	<p>The type of the value encoded in this Content Item.</p> <p>Defined Terms:</p> <p>TEXT NUM CODE DATETIME DATE TIME UIDREF PNAME COMPOSITE IMAGE WAVEFORM SCoord TCoord CONTAINER</p>
Concept Name Code Sequence	(0040,A043)	1C	<p>Code describing the concept represented by this Content Item. Also conveys the value of Document Title and section headings in documents. Only a single Item shall be permitted in this sequence.</p> <p>Required if Value Type (0040,A040) is TEXT or NUM or CODE or DATETIME or DATE or TIME or UIDREF or PNAME.</p> <p>Required if Value Type (0040,A040) is CONTAINER and a heading is present, or this is the Root Content Item.</p> <p>Note: That is, containers without headings do not require Concept Name Code Sequence</p> <p>Required if Value Type (0040,A040) is COMPOSITE, IMAGE, WAVEFORM, SCoord or TCoord, and the Purpose of Reference is conveyed in the Concept Name.</p> <p>See C.17.3.1 for further explanation.</p>
>Include 'Code Sequence Macro' Table 8.8-1		<p>Defined Context IDs to convey the Purpose of Reference are:</p> <p>99 "Purpose of Reference"</p> <p>178 "Spatial Extent of Finding"</p>	

Continuity of Content	(0040,A050)	1C	<p>This flag specifies for a CONTAINER whether or not its contained Content Items are logically linked in a continuous textual flow, or are separate items.</p> <p>Required if Value Type (0040,A040) is CONTAINER.</p> <p>Enumerated Values: SEPARATE CONTINUOUS</p> <p>See C.17.3.2 for further explanation.</p>
Text Value	(0040,A160)	1C	<p>This is the value of the Content Item.</p> <p>Required if Value Type (0040,A040) is TEXT.</p> <p>Text data which is unformatted and whose manner of display is implementation dependent.</p> <p>The text value may contain spaces, as well as multiple lines separated by either LF, CR, CR LF or LF CR, but otherwise no format control characters (such as horizontal or vertical tab and form feed) shall be present, even if permitted by the Value Representation of UT.</p> <p>The text shall be interpreted as specified by Specific Character Set (0008,0005) if present in the SOP Common Module.</p> <p>Note: The text may contain single or multi-byte characters and use code extension techniques as described in PS 3.5 if permitted by the values of Specific Character Set (0008,0005).</p>
DateTime	(0040,A120)	1C	<p>This is the value of the Content Item.</p> <p>Required if Value Type (0040,A040) is DATETIME.</p>
Date	(0040,A121)	1C	<p>This is the value of the Content Item.</p> <p>Required if Value Type (0040,A040) is DATE.</p>
Time	(0040,A122)	1C	<p>This is the value of the Content Item.</p> <p>Required if Value Type (0040,A040) is TIME.</p>
Person Name	(0040,A123)	1C	<p>This is the value of the Content Item.</p> <p>Required if Value Type (0040,A040) is PNAME.</p>
UID	(0040,A124)	1C	<p>This is the value of the Content Item.</p> <p>Required if Value Type (0040,A040) is UIDREF.</p>
<p><i>Include 'Numeric Measurement Macro' Table C.18.1-1 if and only if Value Type (0040,A040) is NUM.</i></p>			

<i>Include 'Code Macro' Table C.18.2-1 if and only if Value Type (0040,A040) is CODE.</i>
<i>Include 'Composite Object Reference Macro' Table C.18.3-1 if and only if Value Type (0040,A040) is COMPOSITE.</i>
<i>Include 'Image Reference Macro' Table C.18.4-1 if and only if Value Type (0040,A040) is IMAGE.</i>
<i>Include 'Waveform Reference Macro' Table C.18.5-1 if and only if Value Type (0040,A040) is WAVEFORM.</i>
<i>Include 'Spatial Coordinates Macro' Table C.18.6-1 if and only if Value Type (0040,A040) is SCOOD.</i>
<i>Include 'Temporal Coordinates Macro' Table C.18.7-1 if and only if Value Type (0040,A040) is TCOORD.</i>

C.17.3.1 Concept Name Code Sequence

The Concept Name Code Sequence (0040,A043) conveys the name of the concept whose value is expressed by the value attribute or set of attributes. Depending on the Value Type (0040,A040), the meaning of the Concept Name Code Sequence may reflect specifics of the use of the particular data type (see Table C.17.3-1).

C.17.3.2 Continuity of Content

Continuity of Content (0040,A050) specifies whether or not all the Content Items contained in a CONTAINER are logically linked in a continuous textual flow, or are separate entities. It only applies to the children contained in the container, and not their children (which if containers themselves, will have the attribute specified explicitly).

Note: This allows the interspersing of measurements, codes, and image references, amongst text. For example, the following: "A mass of diameter = 3 cm was detected." can be represented by the following Content Items in a CONTAINER with a Continuity of Content (0040,A050) of CONTINUOUS:

TEXT "A mass of"

NUM "Diameter"="3" "cm"

TEXT "was detected."

C.17.4 SR Content Tree Example (Informative)

Figure C.17.4-1 depicts the content of an example diagnostic interpretation.

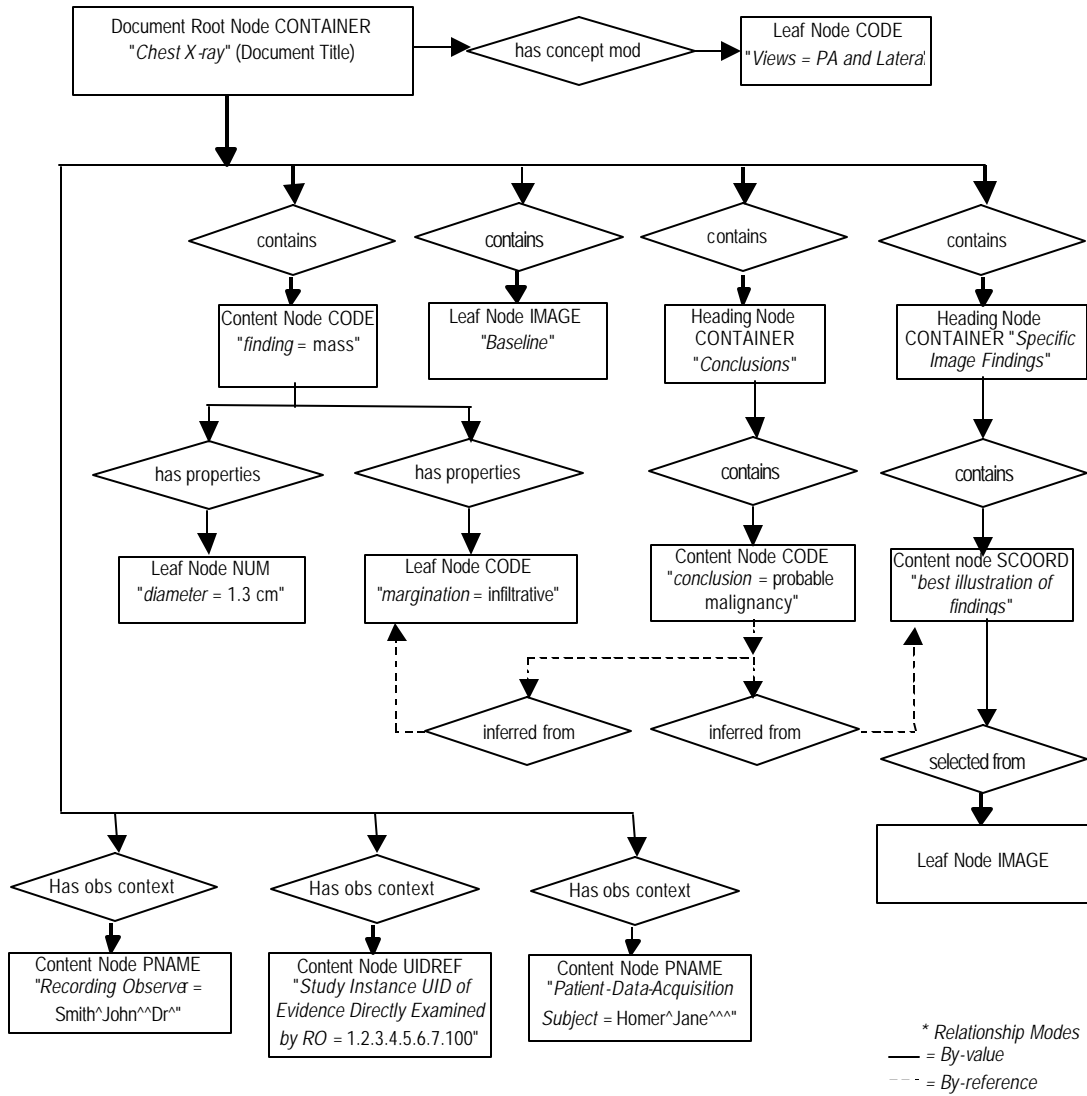

- Notes:
1. For nodes of type CONTAINER, the contents of the Concept Name Code Sequence are shown in quotes and italicized.
 2. For nodes of Value Type CODE, PNAME, NUM the contents are shown as "Concept Name Code Sequence = Value".
 3. For the nodes of Value Type IMAGE and SCOORD, the contents of the Concept Name Code Sequence indicating the purpose of reference are shown in quotes and italicized.

4. The root node containing the Document Type is illustrated using a post-coordinated node of "Chest X-ray", qualified using a HAS CONCEPT MOD relationship by a child with a CODE meaning "Views = PA and Lateral". An alternative would be to use a single pre-coordinated code in one node that applies to the entire concept of a "Two-view (PA and Lateral) Chest X-ray". However, the use of pre-coordinated terms to describe complex concepts rapidly becomes unwieldy and difficult to search on (in the sense that more specific pre-coordinated codes do not have a visible relationship with more general codes). If it were necessary to include a longer textual description of Document Type, then this could be achieved with a HAS CONCEPT MOD relationship with one or more TEXT nodes, perhaps in different languages.
5. The Document Type is only a title, and is not being used to convey the Procedure Context, although in this example it does appear to contain a description of some aspects of Procedure Context.

Figure C.17.4-1 (Informative)
SR Content Tree for an Example Diagnostic Interpretation

C.17.5 OBSERVATION CONTEXT ENCODING

Observation Context describes who or what is performing the interpretation, whether the examination of evidence is direct or quoted, what procedure generated the evidence that is being interpreted, and who or what is the subject of the evidence that is being interpreted.

Initial Observation Context is defined outside the SR Document Content tree by other modules in the SR IOD (i.e., Patient Module, Specimen Identification, General Study, Patient Study, SR Document Series, General Equipment and SR Document General modules). Observation Context defined by attributes in these modules applies to all Content Items in the SR Document Content tree and need not be explicitly coded in the tree. The initial Observation Context from outside the tree can be explicitly replaced.

If a Content Item in the SR Document Content tree has Observation Context different from the context already encoded elsewhere in the IOD, the context information applying to that Content Item shall be encoded as child nodes of the Content Item in the tree using the HAS OBS CONTEXT relationship. That is, Observation Context is a property of its parent Content Item.

The context information specified in the Observation Context child nodes (i.e. target of the HAS OBS CONTEXT relationship) adds to the Observation Context of their parent node Content item, and shall apply to all the by-value descendant nodes of that parent node regardless of the relationship type between the parent and the descendant nodes. Observation Context is encoded in the same manner as any other Content Item. See the example in Figure C.17.5-1. Observation Context shall not be inherited across by-reference relationships.

- Notes:
1. For example, the "subject context" may be defined by attaching an appropriate content item to the root node with a HAS OBS CONTEXT relationship. This "subject context" then applies not only to the root node, but to all its descendants, until such time as a content item explicitly replaces the "subject context" attribute, the new value of which is then inherited by all of that nodes descendants.
 2. For example, one can extend the observation context that specifies the procedure being interpreted, either from that inherited from outside the tree or from ancestors within the tree, by adding further content items that specify identifying information, such as HL7 placer and filler order numbers.

Observation DateTime is not included as part of the HAS OBS CONTEXT relationship, and therefore is not inherited along with other Observation Context. The Observation DateTime Attribute is included in each Content Item which allows different observation dates and times to be attached to different Content Items.

The IOD may specify restrictions on Content Items and Relationship Types that also constrain the flexibility with which Observation Context may be described.

The IOD may specify Templates that offer or restrict patterns and content in Observation Content.

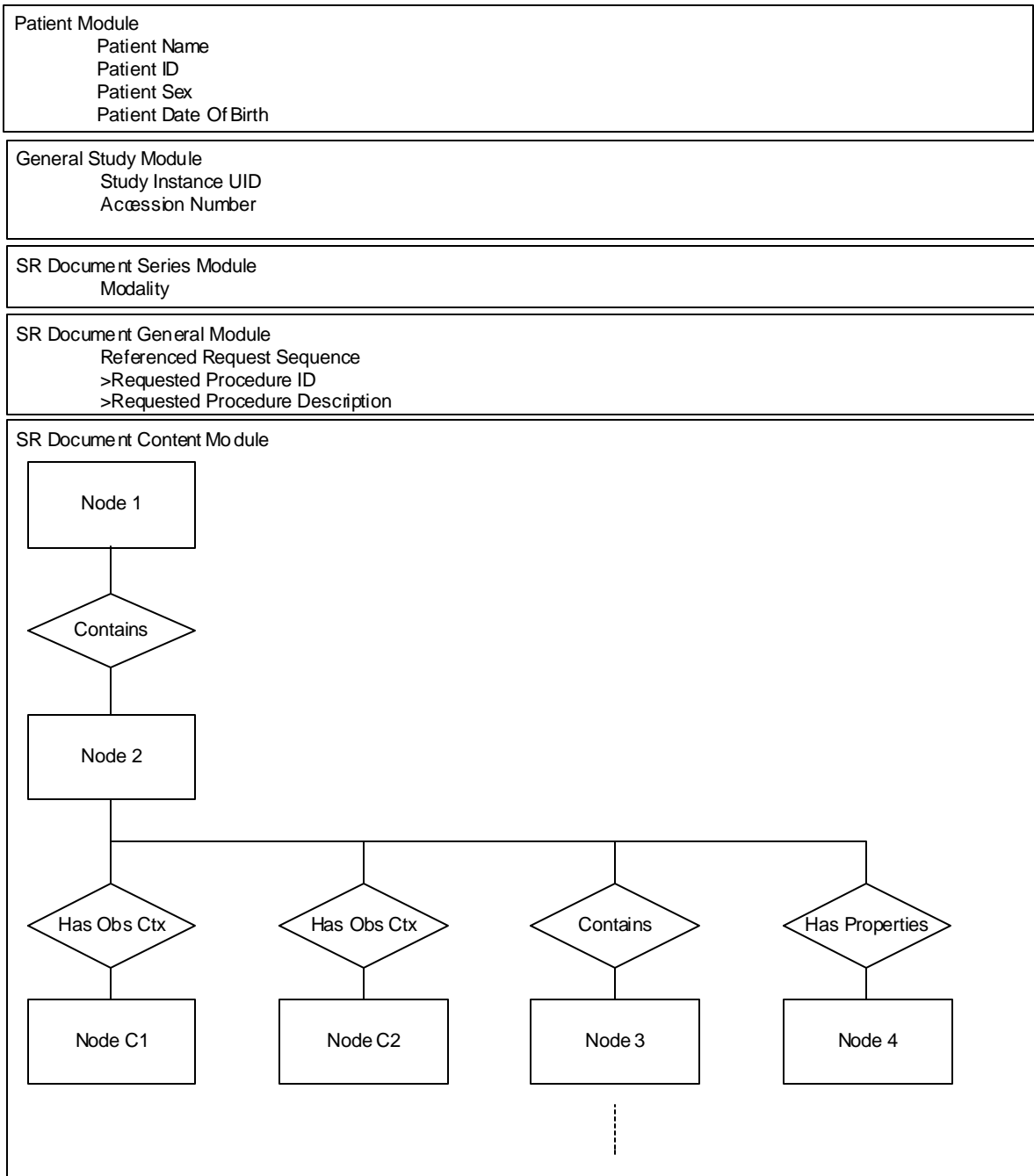

- Notes:
1. Node 2 inherits any Observation Context of Node 1, which is then extended or replaced by the additional Observation Context defined in Nodes C1 and C2 (that is C1 and C2 are properties of 2).
 2. Node 3 and its descendents inherit the Observation Context of Node 2, which includes C1 and C2.
 3. Node 4 inherits the Observation Context of Node 2, which includes C1 and C2.

Figure C.17.5-1 (Informative)
Definition and Inheritance of Observation Context

C.17.6 Key Object Selection Modules

C.17.6.1 Key Object Document Series Module

Table C.17.6-1 defines the Attributes of the Key Object Document Series.

Note: Series of Key Object Selection Documents are separate from Series of Images or other Composite SOP Instances. Key Object Documents do not reside in a Series of Images or other Composite SOP Instances.

Table C.17.6-1
KEY OBJECT DOCUMENT SERIES MODULE ATTRIBUTES

Attribute Name	Tag	Type	Attribute Description
Modality	(0008,0060)	1	Modality type. Enumerated Value: KO = Key Object Selection
Series Instance UID	(0020,000E)	1	Unique identifier of the Series. Note: No specific semantics are specified.
Series Number	(0020,0011)	1	A number that identifies the Series. Note: No specific semantics are specified.
Referenced Study Component Sequence	(0008,1111)	2	Uniquely identifies the Performed Procedure Step SOP Instance for which the Series is created. Only a single Item shall be permitted in this sequence. Notes: See notes on this attribute in Section C.17.1 SR Document Series Module
>Referenced SOP Class UID	(0008,1150)	1C	Uniquely identifies the referenced SOP Class. Required if Referenced Study Component Sequence (0008,1111) is sent.
> Referenced SOP Instance UID	(0008,1155)	1C	Uniquely identifies the referenced SOP Instance. Required if Referenced Study Component Sequence (0008,1111) is sent.

C.17.6.2 Key Object Document Module

Table C.17.6-2 defines the general Attributes of a Key Object Selection Document. These Attributes identify and provide context for the Key Object Selection Document.

Table C.17.6-2
KEY OBJECT DOCUMENT MODULE ATTRIBUTES

Attribute Name	Tag	Type	Attribute Description
Instance Number	(0020,0013)	1	A number that identifies the Document.
Content Date	(0008,0023)	1	The date the document content creation started.

Content Time	(0008,0033)	1	The time the document content creation started.
Referenced Request Sequence	(0040,A370)	1C	Identifies Requested Procedures to which this Document pertains. One or more Items may be included in this sequence. Required if this Document pertains to at least one Requested Procedure.
>Study Instance UID	(0020,000D)	1	Unique identifier for the Study.
>Referenced Study Sequence	(0008,1110)	2	Uniquely identifies the Study SOP Instance. Only a single Item shall be permitted in this sequence.
>>Referenced SOP Class UID	(0008,1150)	1	Uniquely identifies the SOP Class
>>Referenced SOP Instance UID	(0008,1155)	1	Uniquely identifies the SOP Instance.
>Accession Number	(0008,0050)	2	A departmental IS generated number which identifies the order for the Study.
>Placer Order Number/Imaging Service Request	(0040,2016)	2	The order number assigned to the Imaging Service Request by the party placing the order.
>Filler Order Number/Imaging Service Request	(0040,2017)	2	The order number assigned to the Imaging Service Request by the party filling the order.
>Requested Procedure ID	(0040,1001)	2	Identifier of the related Requested Procedure
>Requested Procedure Description	(0032,1060)	2	Institution-generated administrative description or classification of Requested Procedure.
>Requested Procedure Code Sequence	(0032,1064)	2	A sequence that conveys the requested procedure. Zero or one Item may be included in this sequence.
>>Include 'Code Sequence Macro' Table 8.8-1		No Baseline Context ID Number is specified.	
Current Requested Procedure Evidence Sequence	(0040,A375)	1	List of all Composite SOP Instances referenced in the Content Sequence (0040,A730). One or more Items shall be included in this sequence. Note: In the context of the Key Object Selection, the current evidence is considered to be only the set of instances referenced within the Key Object Selection.
>Include 'SOP Instance Reference Macro' Table C.17-3			

Identical Documents Sequence	(0040,A525)	1C	Duplicates of this document, stored with different SOP Instance UIDs. One or more Items may be included in this sequence. Required if this Key Object Selection document references instances in one or more other Studies. See C.17.2.2 and C.17.6.2.1 for further explanation and conditions.
<i>>Include 'SOP Instance Reference Macro' Table C.17-3</i>			

C.17.6.2.1 Identical Documents

If the Current Requested Procedure Evidence Sequence (0040,A375) references SOP Instances both in the current study and in one or more other studies, this document shall be duplicated into each of those other studies, and the duplicates shall be referenced in the Identical Documents Sequence (0040,A525).

Note: Thus a Key Object Selection Document that references images in the current study as well as in a prior or comparison study, would be duplicated into the other study. This allows an application displaying that other study to easily access notes relevant to that study's SOP Instances.

C.18 CONTENT MACROS

C.18.1 Numeric Measurement Macro

Table C.18.1-1 specifies the Attributes that convey a NUM (numeric measurement) value.

Note: The Measured Value Sequence (0040,A300) may be empty to convey the concept of a measurement whose value is unknown or missing.

**Table C.18.1-1
NUMERIC MEASUREMENT MACRO ATTRIBUTES**

Attribute Name	Tag	Type	Attribute Description
Measured Value Sequence	(0040,A300)	2	This is the value of the Content Item. Shall consist of a Sequence of Items conveying the measured value(s), which represent integers or real numbers and units of measurement. Zero or one Items shall be permitted in this sequence.
>Numeric Value	(0040,A30A)	1	Numeric measurement value. Only a single value shall be present.
>Measurement Units Code Sequence	(0040,08EA)	1	Units of measurement. Only a single Item shall be permitted in this sequence.
<i>>>Include 'Code Sequence Macro' Table 8.8-1</i>			<i>Defined Context ID is 82.</i>

C.18.2 Code Macro

Table C.18.2-1 specifies the Attributes that convey a CODE value.

Table C.18.2-1

CODE MACRO ATTRIBUTES

Attribute Name	Tag	Type	Attribute Description
Concept Code Sequence	(0040,A168)	1	This is the value of the Content Item. Only a single Item shall be permitted in this sequence.
>Include 'Code Sequence Macro' Table 8.8-1			No Baseline Context ID is specified.

C.18.3 Composite Object Reference Macro

Table C.18.3-1 specifies the Attributes that convey a reference to a DICOM Composite Object that is not a DICOM Image or Waveform (such as an SR Document).

- Notes:
1. If a Softcopy Presentation State is to be applied to an Image, it should be referenced by an Image Reference Macro.
 2. Other SR Documents may be referenced by this macro, but there is no facility to reference individual Content Items within those reports.

**Table C.18.3-1
COMPOSITE OBJECT REFERENCE MACRO ATTRIBUTES**

Attribute Name	Tag	Type	Attribute Description
Referenced SOP Sequence	(0008,1199)	1	References to Composite Object SOP Class/SOP Instance pairs. Only a single Item shall be permitted in this Sequence.
>Referenced SOP Class UID	(0008,1150)	1	Uniquely identifies the referenced SOP Class.
>Referenced SOP Instance UID	(0008,1155)	1	Uniquely identifies the referenced SOP Instance.

C.18.4 Image Reference Macro

Table C.18.4-1 specifies the Attributes that convey a reference to a DICOM image.

**Table C.18.4-1
IMAGE REFERENCE MACRO ATTRIBUTES**

Attribute Name	Tag	Type	Attribute Description
<i>Include 'Composite Object Reference Macro' Table C.18.3-1</i>			
>Referenced Frame Number	(0008,1160)	1C	Identifies the frame numbers within the Referenced SOP Instance to which the reference applies. The first frame shall be denoted as frame number 1. Note: This Attribute may be multi-valued. Required if the Referenced SOP Instance is a multi-frame image and the reference does not apply to all frames.
>Referenced SOP Sequence	(0008,1199)	3	Reference to a Softcopy Presentation State SOP Class/SOP Instance pair. Only a single Item shall be permitted in this sequence.

>>Referenced SOP Class UID	(0008,1150)	1	Uniquely identifies the referenced SOP Class. Shall be the same for all Images referenced by this presentation state.
>>Referenced SOP Instance UID	(0008,1155)	1	Uniquely identifies the referenced SOP Instance.
>Icon Image Sequence	(0088,0200)	3	This Icon Image is representative of the Image. The Icon Image may be no greater than 128 rows by 128 columns.
>>Image Pixel Module			See Section F.7.

C.18.5 Waveform Reference Macro

Table C.18.5-1 specifies the Attributes that convey a reference to a DICOM waveform.

**Table C.18.5-1
WAVEFORM REFERENCE MACRO ATTRIBUTES**

Attribute Name	Tag	Type	Attribute Description
<i>Include 'Composite Object Reference Macro' Table C.18.3-1</i>			
>Referenced Waveform Channels	(0040,A0B0)	1C	List of channels in Waveform to which the reference applies. See C.18.5.1.1 Required if the Referenced SOP Instance is a Waveform that contains multiple Channels and not all Channels in the Waveform are referenced.

C.18.5.1 Waveform Reference Macro Attribute Descriptions

C.18.5.1.1 Referenced Waveform Channels

Referenced Waveform Channels (0040,A0B0) is a multi-value attribute which lists the channels referenced. Each channel is specified as a pair of values (M,C), where the first value is the sequence item number of the Waveform Sequence (5400,0100) attribute in the referenced object (i.e. the Multiplex Group Number), and the second value is the sequence item number of the Channel Definition Sequence (003A,0200) attribute (i.e., the Channel Number) within the multiplex group.

If the specified channel number is 0, the annotation applies to all channels in the multiplex group.

Note: As an example, an annotation which applies to the entire first multiplex group and channels 2 and 3 of the third multiplex group would have Referenced Waveform Channels (0040,A0B0) value 0001 0000 0003 0002 0003 0003.

C.18.6 Spatial Coordinates Macro

Table C.18.6-1 specifies the Attributes that convey SCORD Content Items. An SCORD Content Item shall always be the Source Content Item of one or more SELECTED FROM Relationships with IMAGE Target Content Items. The IMAGE Target Content Item shall contain a reference to one or more Images.

Note: The same set of spatial coordinates may be selected from more than one single-frame image, or more than one frame of a multi-frame image when the purpose of reference is

applicable to multiple images. For example, the outline of a sampling region at the same spatial location on multiple images acquired over time.

**Table C.18.6-1
SPATIAL COORDINATES MACRO ATTRIBUTES**

Attribute Name	Tag	Type	Attribute Description
Graphic Data	(0070,0022)	1	An ordered set of (column,row) pairs that denote positions in an image specified with sub-pixel resolution such that the origin at the TLHC of the TLHC pixel is 0.0\0.0, the BRHC of the TLHC pixel is 1.0\1.0, and the BRHC of the BRHC pixel is Columns\Rows. The values must be within the range 0\0 to Columns\Rows. The values Columns (0028,0011) and Rows (0028,0010) are those contained in the referenced image. See C.18.6.1.1 for further explanation.
Graphic Type	(0070,0023)	1	See C.18.6.1.2 for Enumerated Values.

C.18.6.1 Spatial Coordinates Macro Attribute Descriptions

C.18.6.1.1 Graphic Data

Graphic Data may be used to associate an anatomic or spatial Concept with a defined subset of one or more images. Graphic Data may be explicitly defined as a single point (i.e. to denote the epicenter of an anatomic site or lesion) or more than one point (i.e. representing a set of points or an open or closed polygon).

Note: Spatial coordinates may be used to associate observational data with a set of Image features. Spatial coordinates also may be used to convey coordinates that are input data for a measurement.

C.18.6.1.2 Graphic Type

When annotation applies to an image, this attribute defines the type of geometry of the annotated region of interest. The following Enumerated Values are specified for image spatial coordinate geometries:

POINT = a single pixel denoted by a single (column,row) pair

MULTIPOINT = multiple pixels each denoted by an (column,row) pair

POLYLINE = a series of connected line segments with ordered vertices denoted by (column,row) pairs; if the first and last vertices are the same it is a closed polygon

CIRCLE = a circle defined by two (column,row) pairs. The first point is the central pixel. The second point is a pixel on the perimeter of the circle.

ELLIPSE = an ellipse defined by four pixel (column,row) pairs, the first two points specifying the endpoints of the major axis and the second two points specifying the endpoints of the minor axis of an ellipse

C.18.7 Temporal Coordinates Macro

Table C.18.7-1 specifies the Attributes that convey TCOORD Content Items. A TCOORD Content Item shall be the Source Content Item of one or more SELECTED FROM relationships with one or more SCOORD Content Items, one or more IMAGE Content Items, or one or more WAVEFORM Content Items.

- Notes:
1. The same set of temporal coordinates may be selected from more than one single-frame image, or more than one frame of a multi-frame image, or from images and waveforms when the purpose of reference is applicable to multiple objects. For example, the definition of a sampling period at different spatial locations on multiple images and a synchronously acquired waveform.
 2. Temporal coordinates may refer to spatial coordinates which in turn refer to one or more frames or images, for example to indicate a region localized in both time and space.

**Table C.18.7-1
TEMPORAL COORDINATES MACRO ATTRIBUTES**

Attribute Name	Tag	Type	Attribute Description
Temporal Range Type	(0040,A130)	1	See C.18.7.1.1 for Enumerated Values.
Referenced Sample Positions	(0040,A132)	1C	List of samples within a multiplex group specifying temporal points of the referenced data. Position of first sample is 1. Required if the Referenced SOP Instance is a Waveform and Referenced Time Offsets (0040,A138) and Referenced Datetime (0040,A13A) are not present. May be used only if Referenced Channels (0040,A0B0) refers to channels within a single multiplex group.
Referenced Time Offsets	(0040,A138)	1C	Specifies temporal points for reference by number of seconds after start of data. Required if Referenced Sample Positions (0040,A132) and Referenced Datetime (0040,A13A) are not present.
Referenced Datetime	(0040,A13A)	1C	Specifies temporal points for reference by absolute time. Required if Referenced Sample Positions (0040,A132) and Referenced Time Offsets (0040,A138) are not present.

C.18.7.1 Temporal Range Type

This Attribute defines the type of temporal extent of the region of interest. A temporal point (or instant of time) may be defined by a waveform sample offset (for a single waveform multiplex group only), time offset, or absolute time.

The following Enumerated Values are specified for Temporal Range Type:

- POINT = a single temporal point
- MULTIPOINT = multiple temporal points

SEGMENT = a range between two temporal points

MULTISEGMENT = multiple segments, each denoted by two temporal points

BEGIN = a range beginning at one temporal point, and extending beyond the end of the acquired data

END = a range beginning before the start of the acquired data, and extending to (and including) the identified temporal point

Annex D Codes and Controlled Terminology (Informative)

Retired.

Annex E Explanation of patient orientation (Normative)

This Annex provides an explanation of how to use the patient orientation data elements.

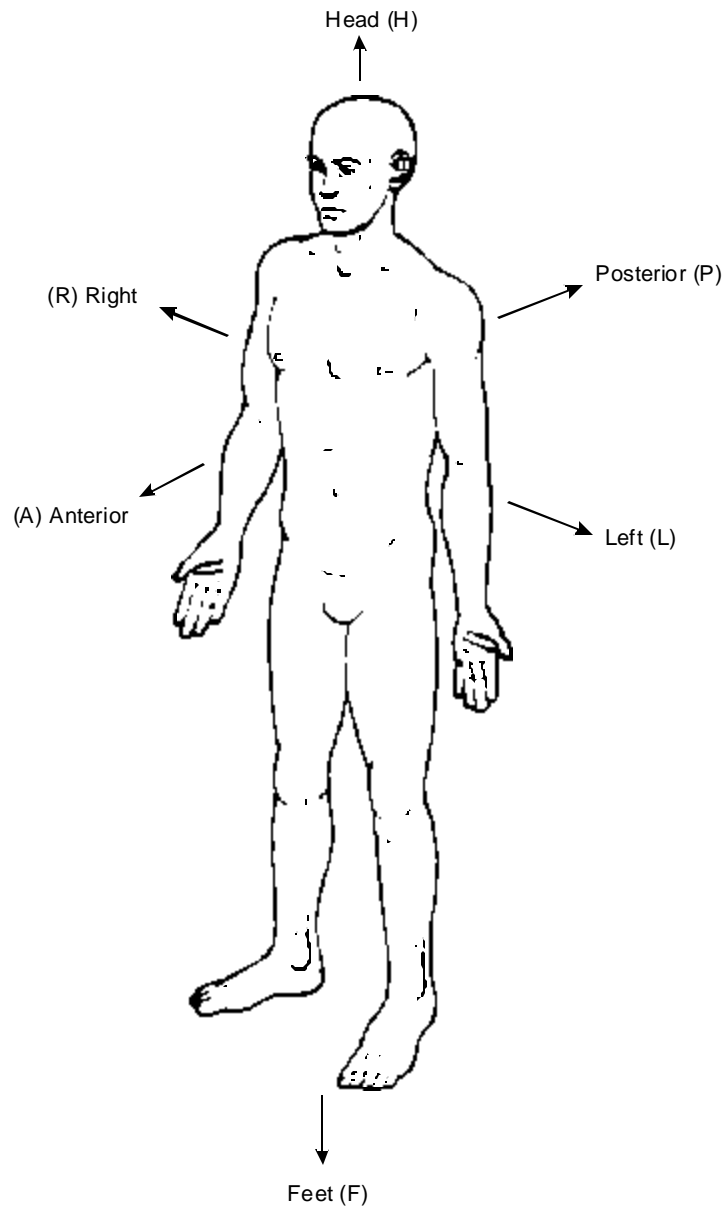

The standard anatomic position is standing erect with the palms facing anterior. This position is used to define a label for the direction of the fingers and toes (toward the Feet (F) while the direction of the wrist and ankle is towards the Head (H). This labeling is retained despite changes in the position of the extremities. For bilaterally symmetric body parts, a laterality indicator (R or L) should be used.

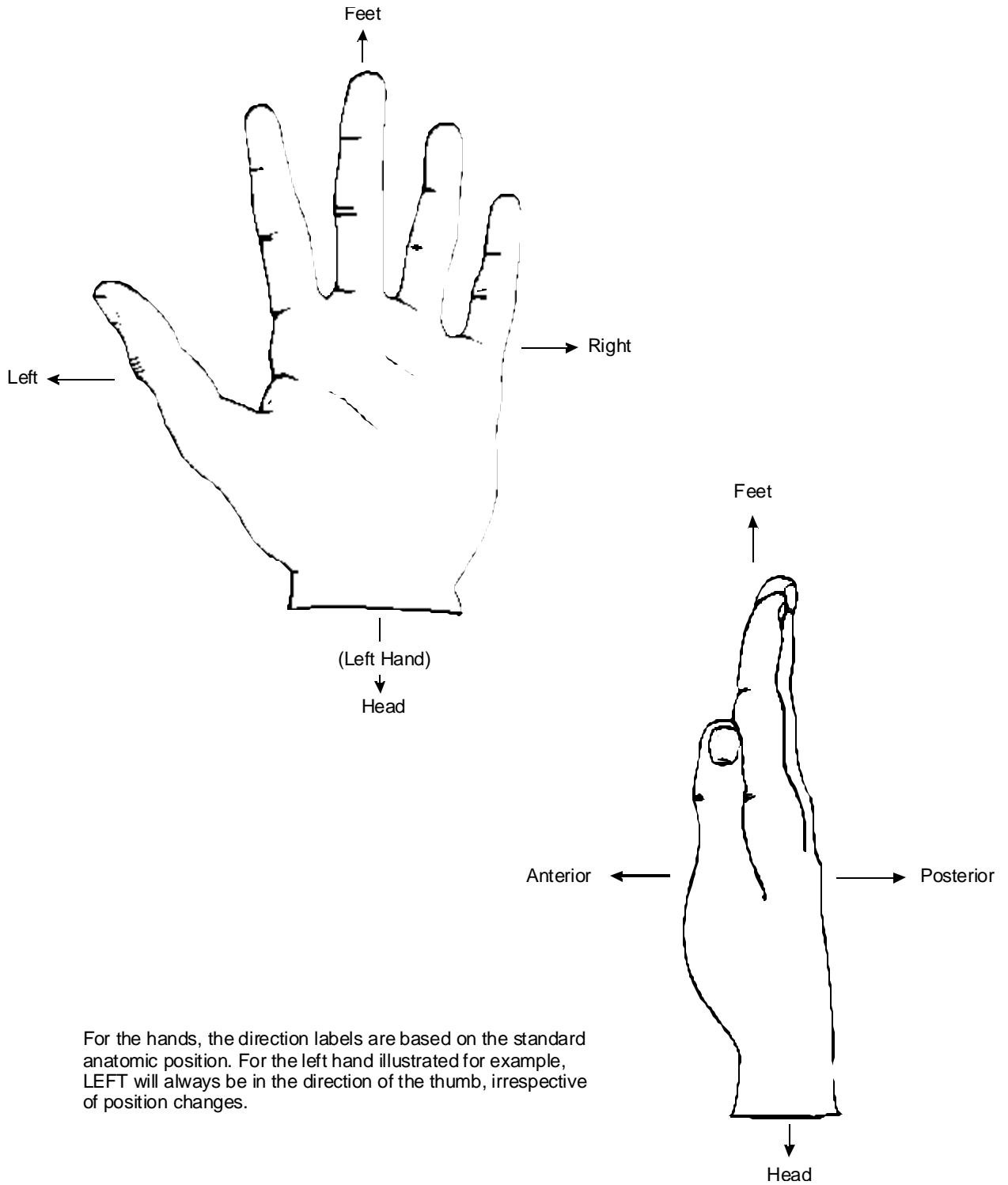

For the hands, the direction labels are based on the standard anatomic position. For the left hand illustrated for example, LEFT will always be in the direction of the thumb, irrespective of position changes.

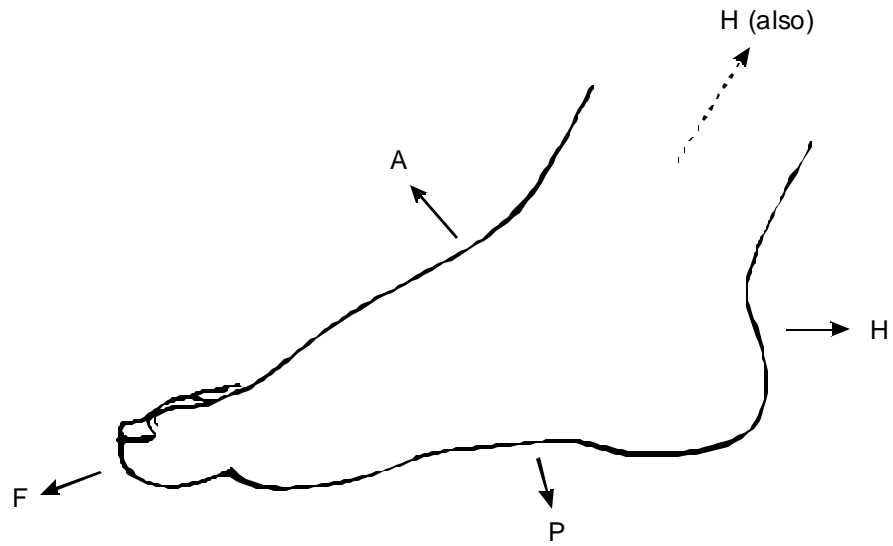

Right Foot

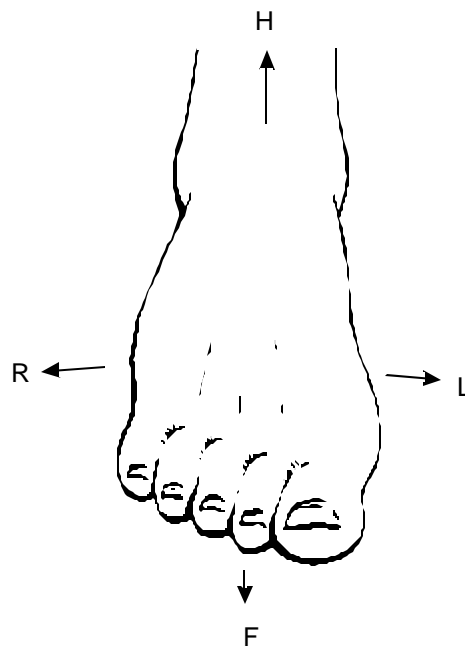

Right Foot - Anterior View

As for the hand, the direction labels are based on the foot in the standard anatomic position. For the right foot, for example, RIGHT will be in the direction of the 5th toe. This assignment will remain constant through movement or positioning of the extremity. This is also true of the HEAD and FOOT directions.

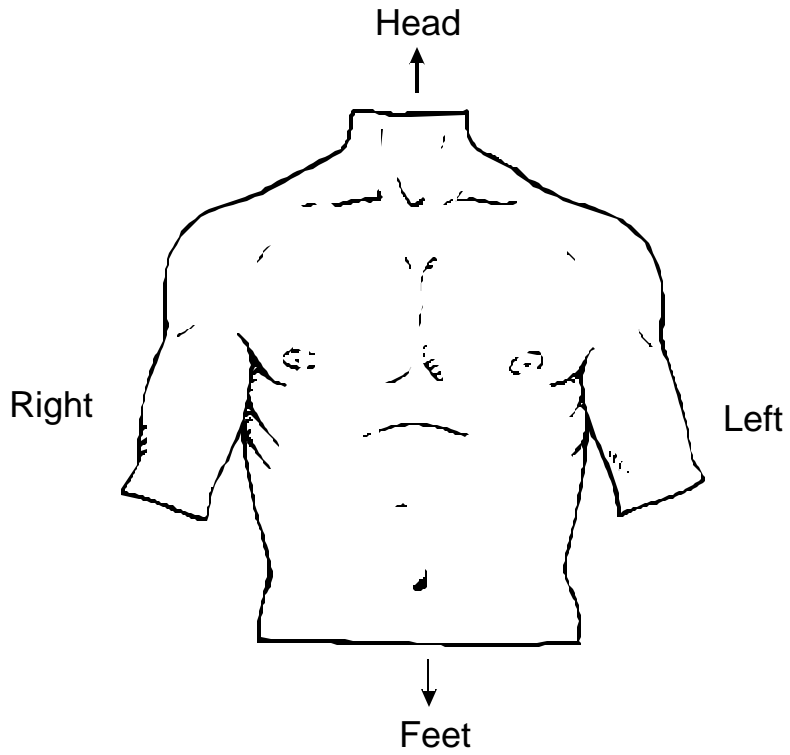

Viewing the Front of the Patient

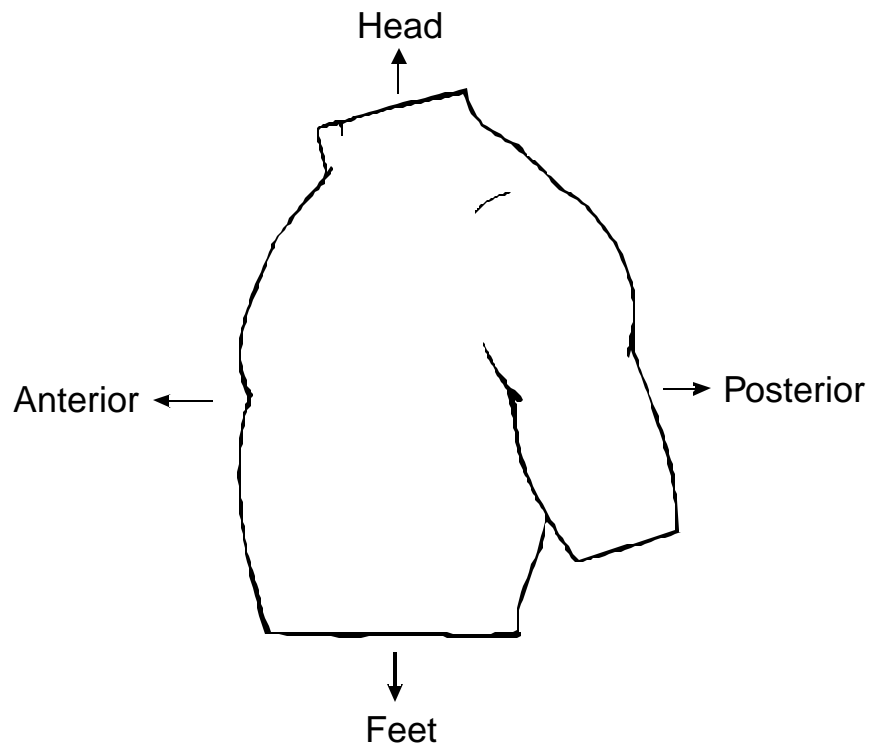

Anterior and left lateral views of the patient. In the view of the left side (bottom illustration) the left arm has been drawn posteriorly.

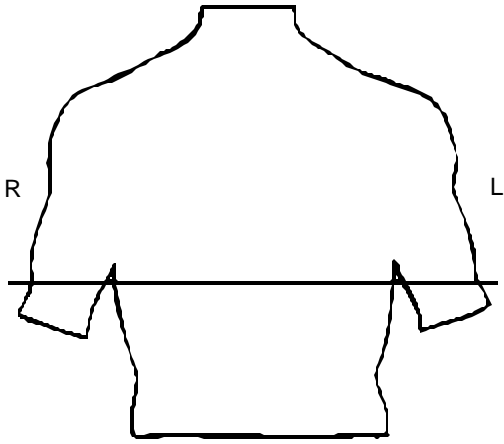

Note:
Bracketed letters along pixel directions
(e.g. [LP]) indicate the pixel row and
column directions.

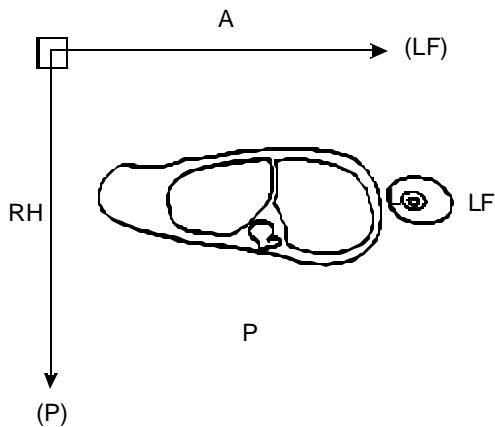
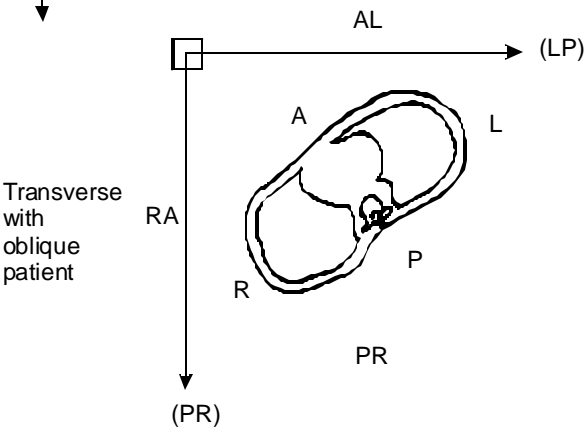
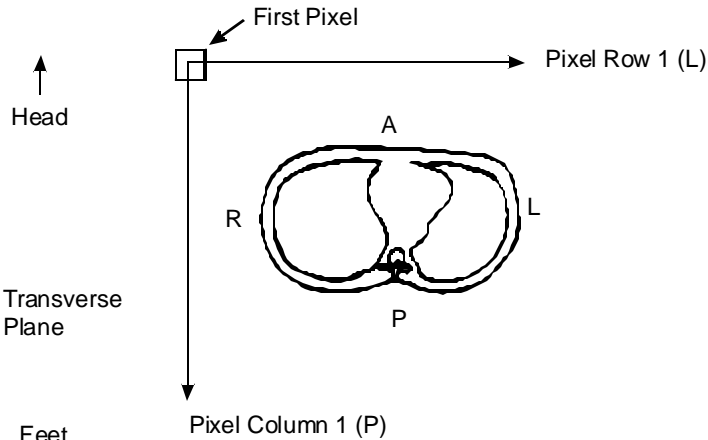
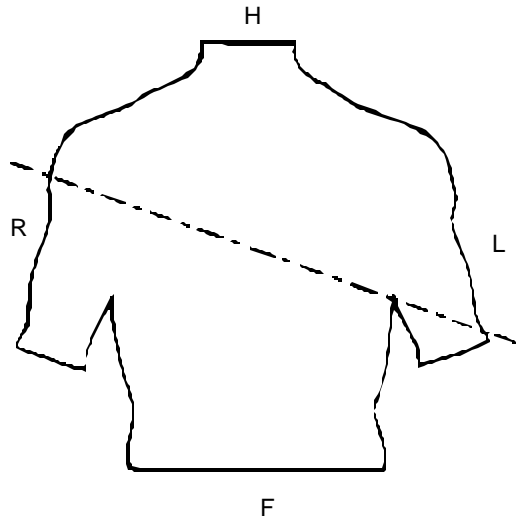

Since the major direction of the transverse plane is right-to-left (or anterior-to-posterior), the first letter of the combined direction will indicate this. For example, RH—moving right also moves towards the head.

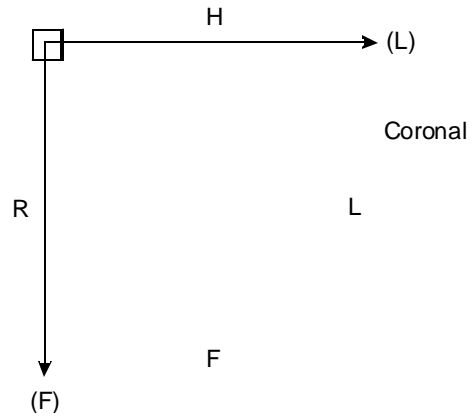
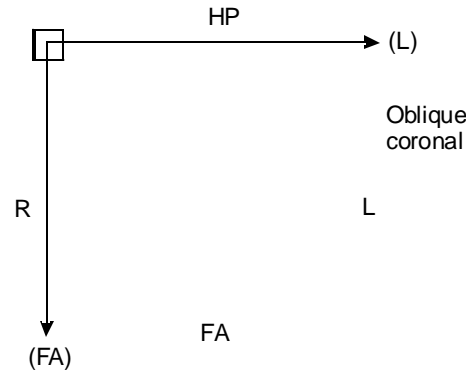
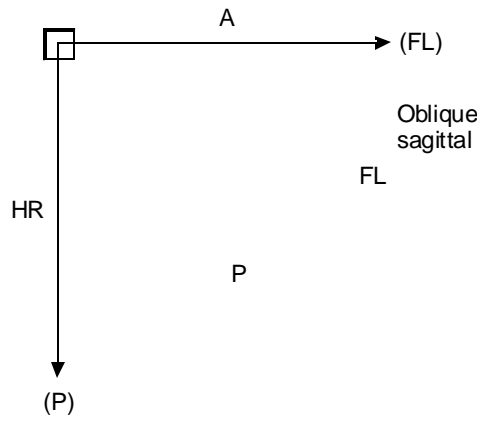
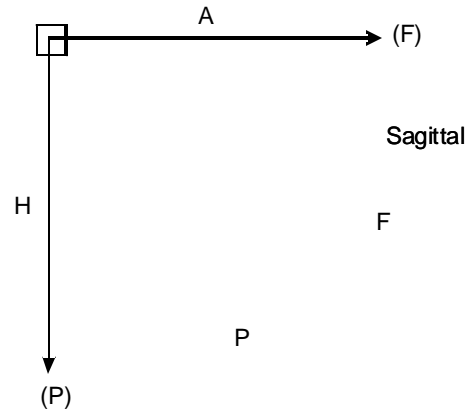
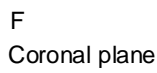
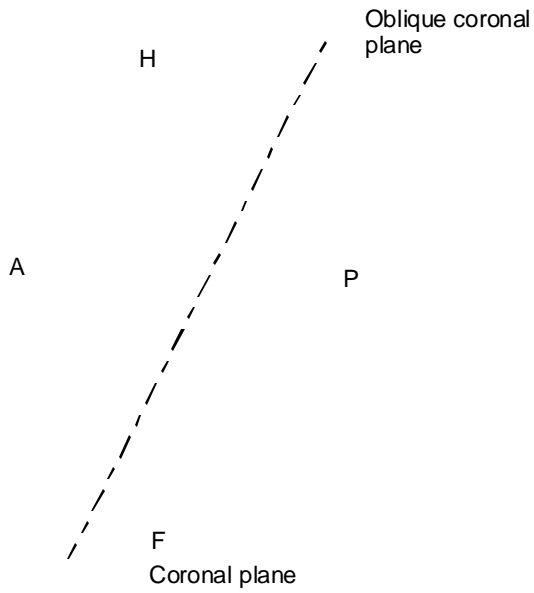
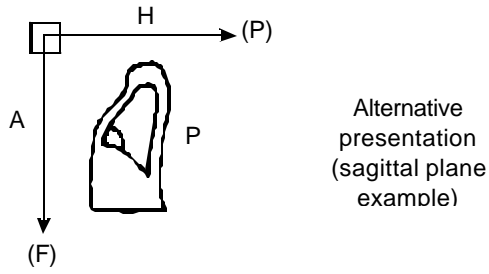
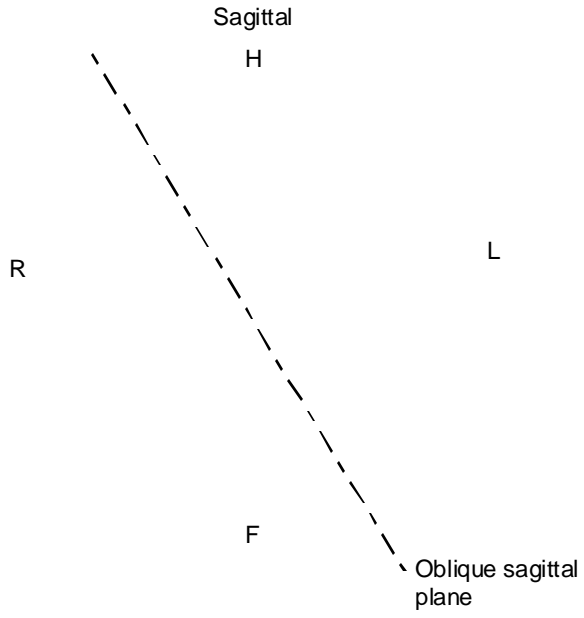

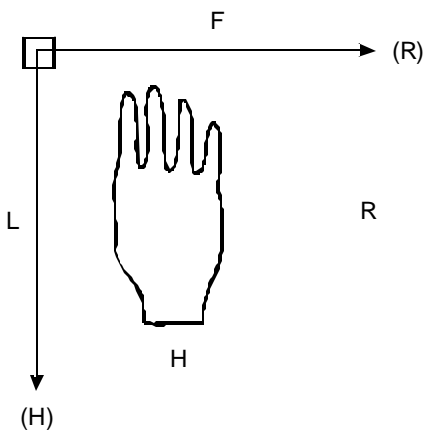
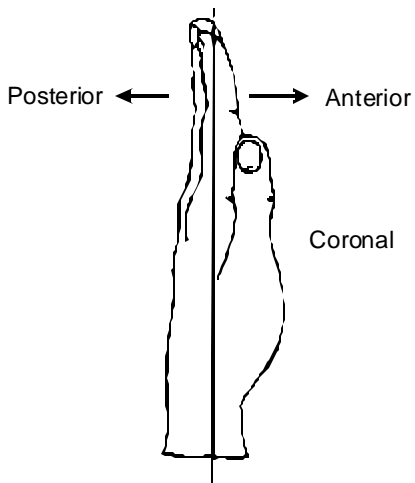
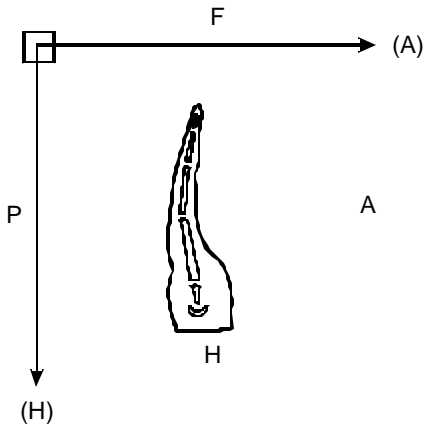
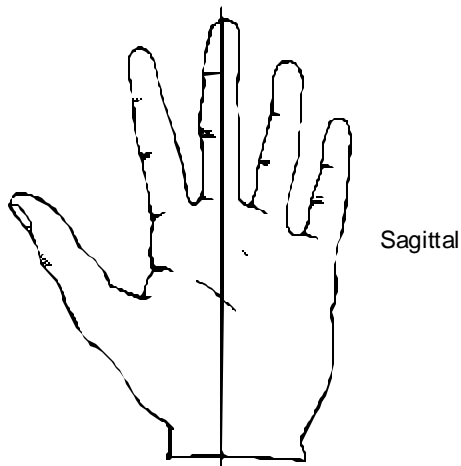
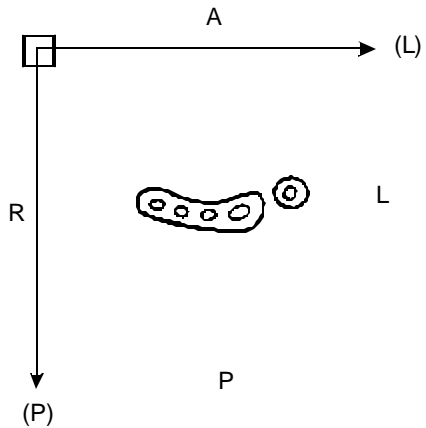
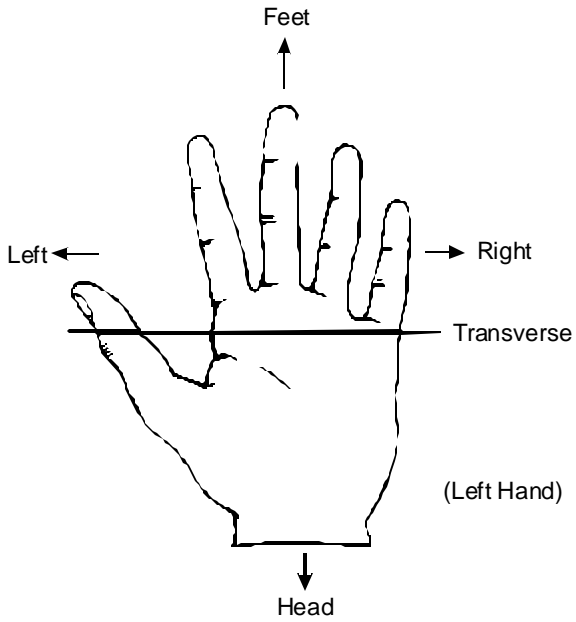

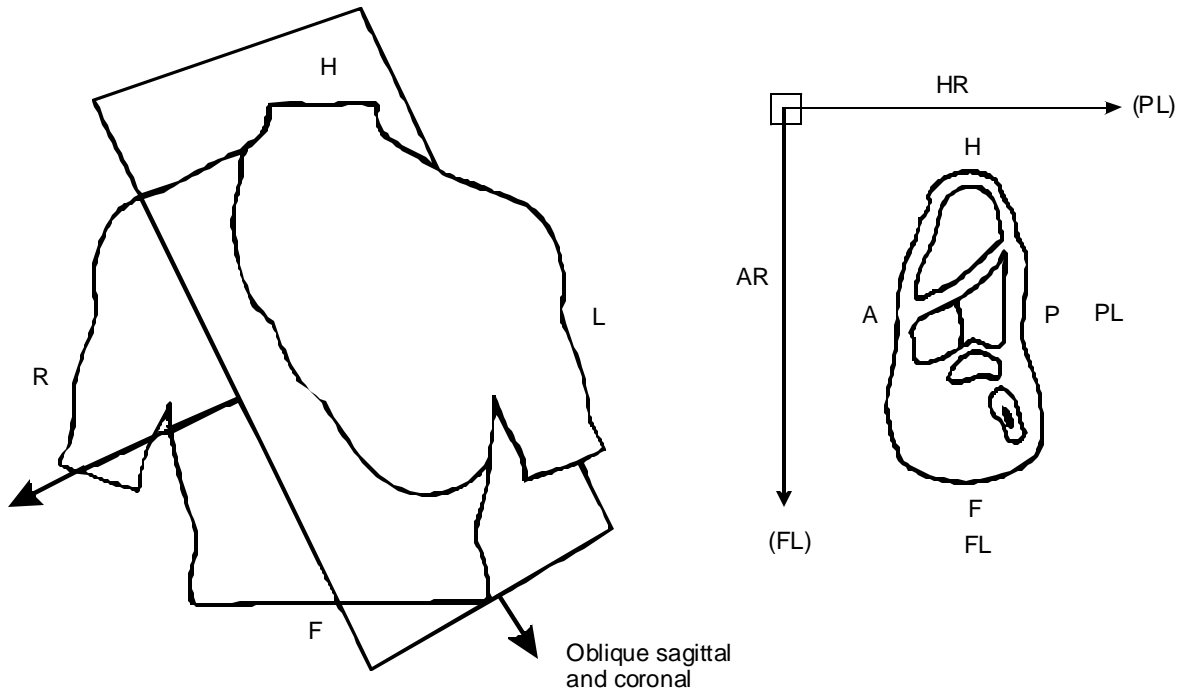

Combined tilt planes and possible labels are based on major plane directions.

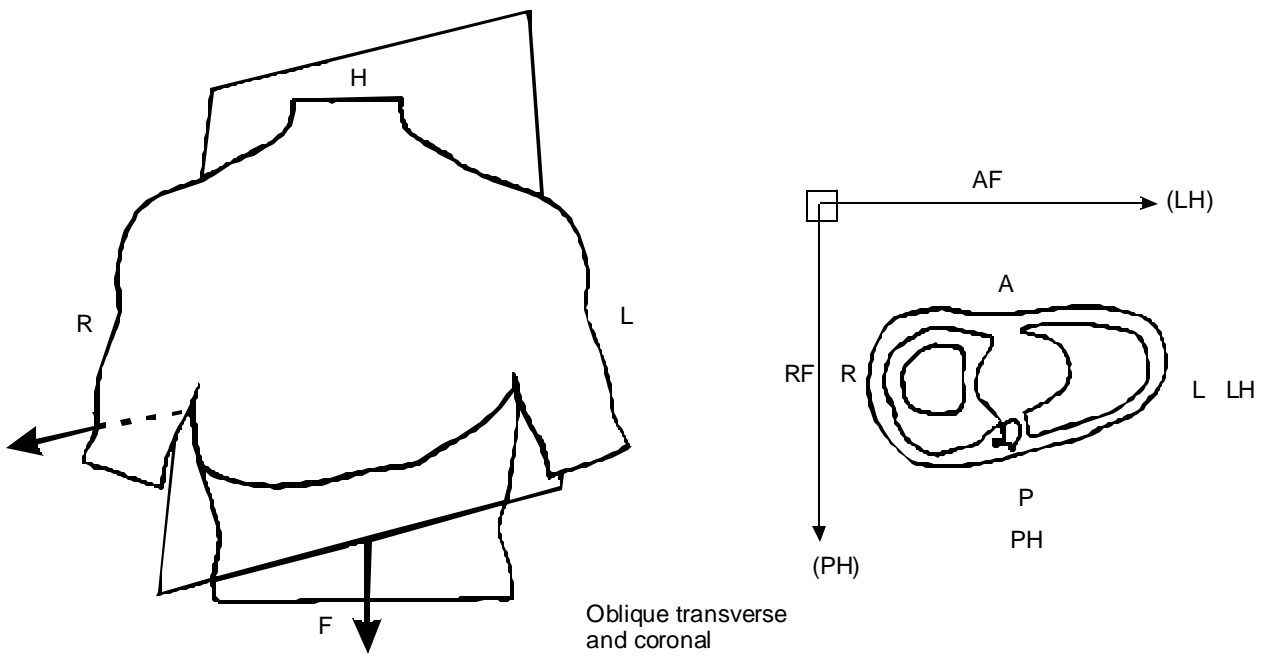

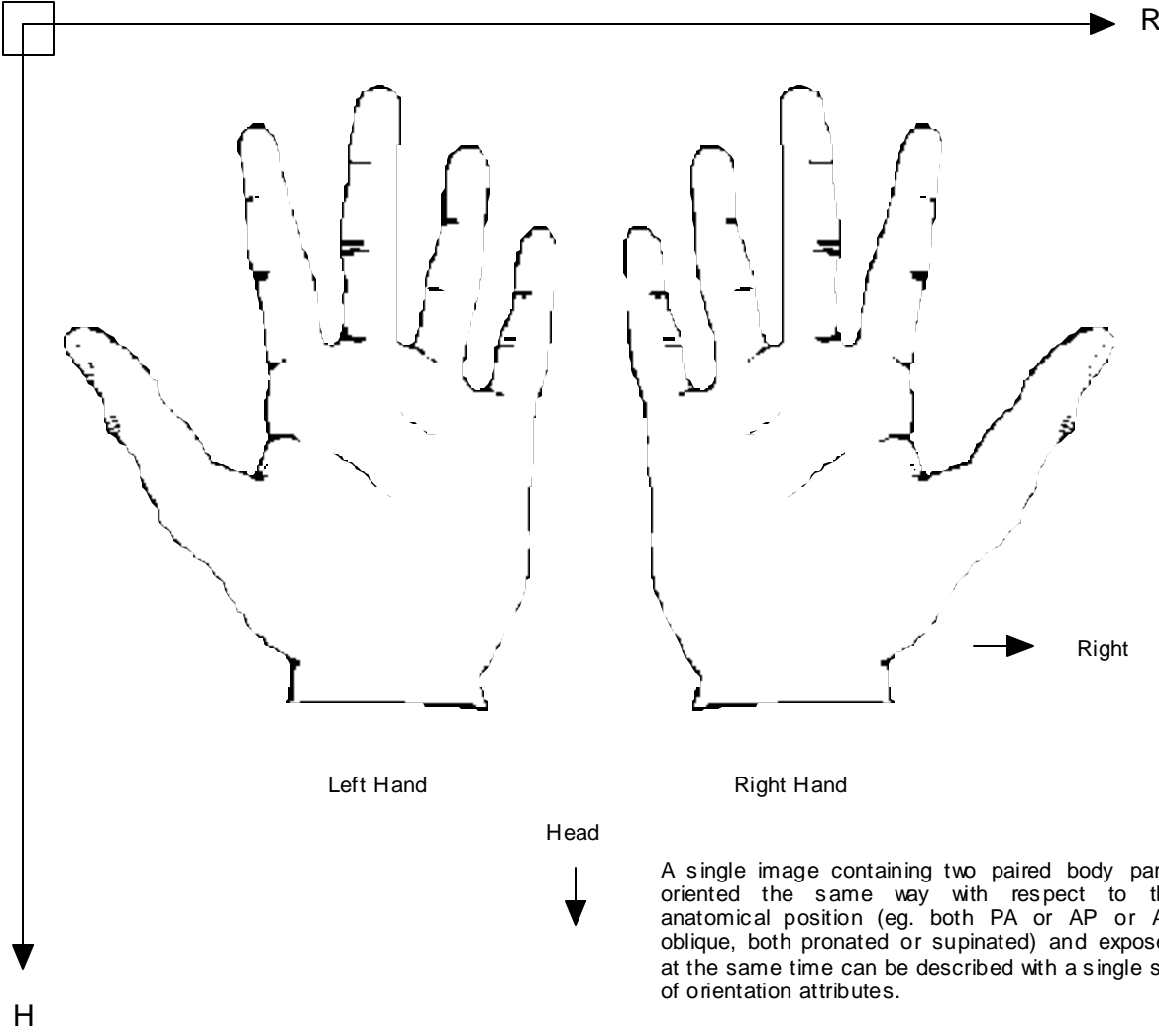

A single image containing two paired body parts oriented the same way with respect to the anatomical position (eg. both PA or AP or AP oblique, both pronated or supinated) and exposed at the same time can be described with a single set of orientation attributes.

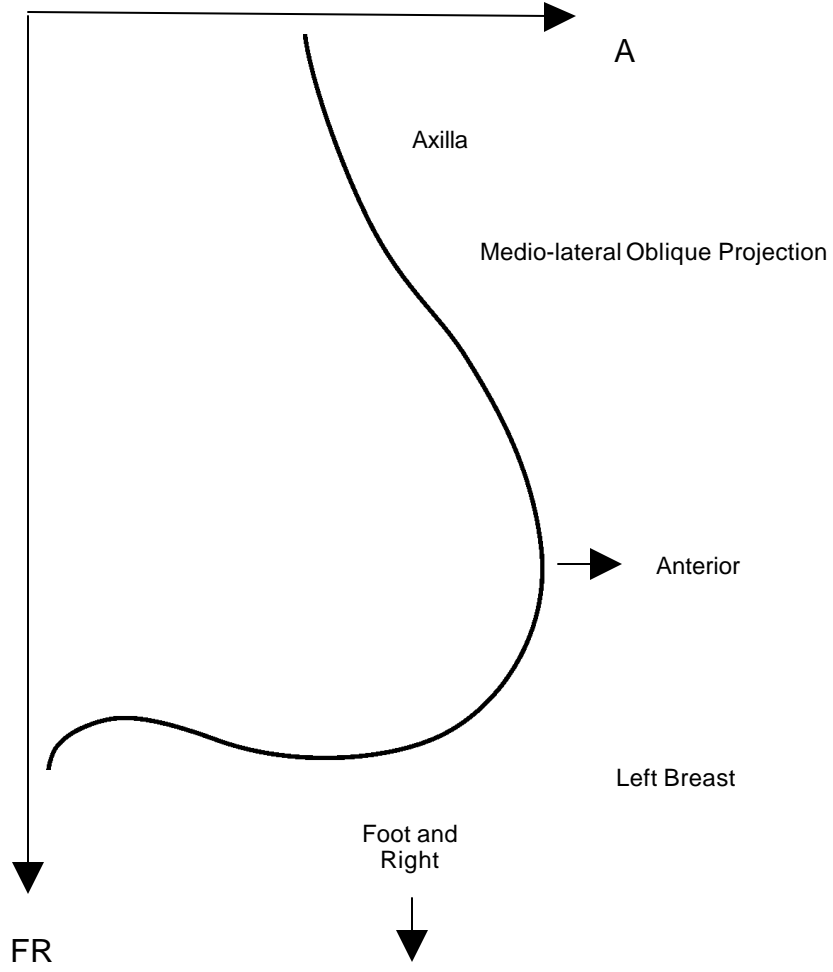

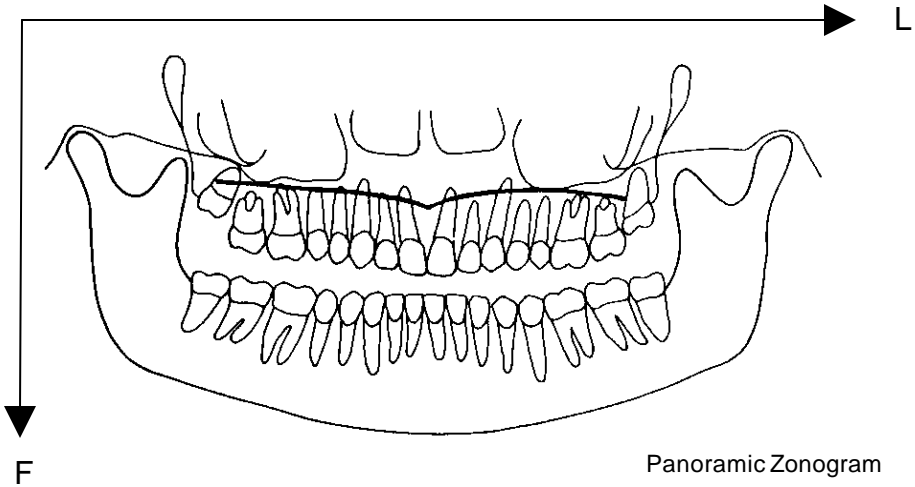
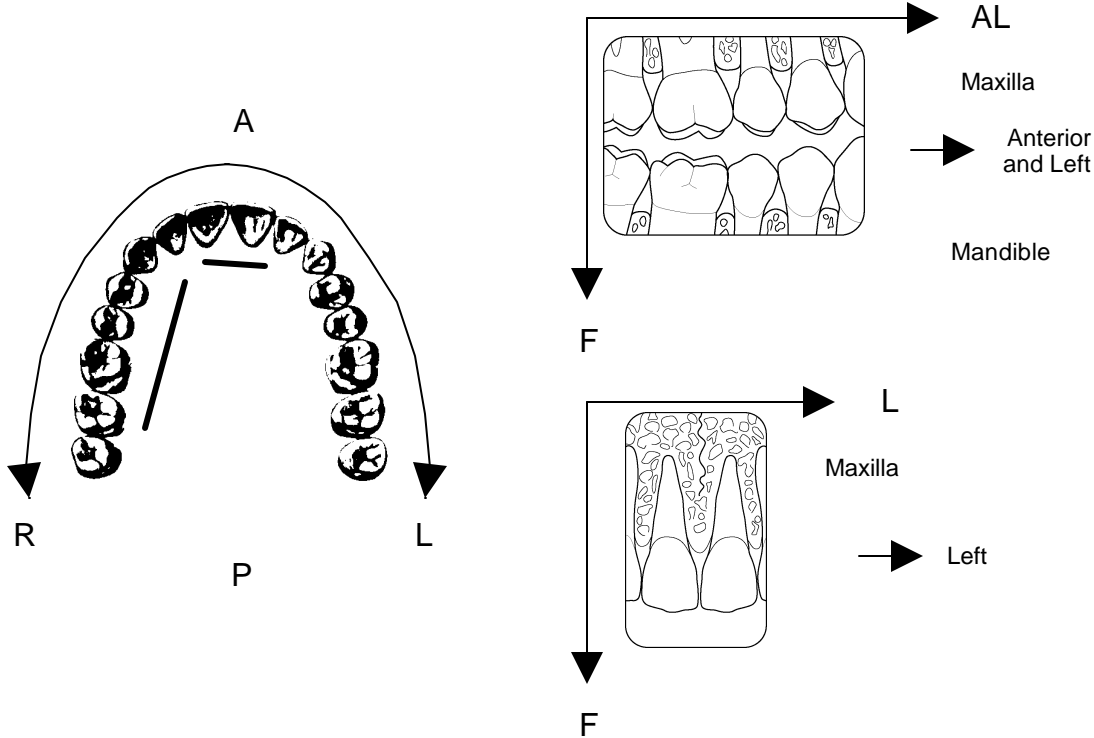

Annex F Basic Directory Information Object Definition (Normative)

F.1 SCOPE OF THE BASIC DIRECTORY INFORMATION IOD

The Basic Directory Information Object Definition may be used for DICOM Media Storage (See PS 3.10) and the Media Storage Service Class (See PS 3.4). It is an abstraction of the information to:

- a. Identify a File-set
- b. Provide a directory which facilitates access to the information stored in the files of a File-set based on key medical information. Such a directory facility relies on a hierarchical information model of medical summary information referencing the content of the Files stored in a File-set on a storage medium. Standardizing such a directory function is a key element to facilitate the interchange of medical imaging data and is intended to support the complete range of modality imaging information.

Note: The directory information has been defined so that a future version of this Part may be extended to support the distribution of the directory information among a logical tree of several files (with the DICOMDIR file at its root). However in this version of this Part, the entire directory information is specified to be stored in a single File with a DICOMDIR File ID.

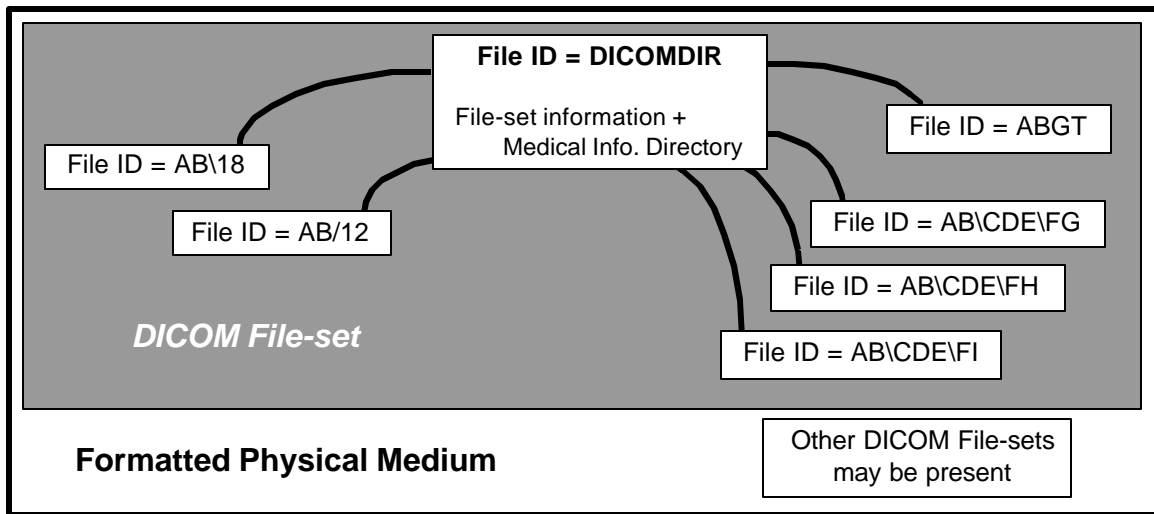

Figure F.1-1
THE DICOMDIR FILE. A CENTRAL ROLE IN A DICOM FILE-SET

- Notes:
1. Whether a single File-set or multiple File-sets are allowed on a formatted Physical Media is defined by the Media Format specification (used for each specific Physical Media) in PS 3.12.
 2. The DICOMDIR File is identified by a single component File ID, DICOMDIR. Other files in the File-set may have File IDs made of a single component (e.g. "ABGT" in the figure above) or multiple components (e.g. AB\12 or AB\CDE\FI) not to exceed 8 components (See PS 3.10).

This Basic Directory Information Object:

- a. is based on a structure of basic medical information. It is not a file system directory such as the one which may be used by the Media Format Layer;

- b. is simple enough to meet the requirements of elementary Media Interchange applications;
- c. is efficient in supporting update to the directory on rewritable media without a complete rewrite of the entire DICOMDIR File;
- d. is extendible for specific applications with specialized selection keys in addition to the standard keys;
- e. does not mandate any relationship between the hierarchy of the medical information in the DICOM Directory and the hierarchy of the File ID Components;

Note: Such an independence between the structure of the file identifiers, from which no semantical information shall be inferred, and the DICOM Directory which conveys medical imaging information, ensures that the broadest inter-operability is possible between conforming DICOM media storage implementations.

F.2 BASIC DIRECTORY IOD OVERVIEW

The general organization of the Basic Directory IOD is introduced in this Section. A simple example is also provided to illustrate the application of this organization.

F.2.1 Basic directory IOD organization

The Basic Directory IOD organization is based on a hierarchy of Directory Entities. At the origin of this inverted tree is a root Directory Entity. Each Directory Entity includes one or more Directory Records which in turn, may each reference a lower level Directory Entity.

Directory Records serve to reference objects stored in the Files of the File-set. The organization of the Directory is depicted by the Basic Directory IOD entity/relationship model presented in Figure F.2-1.

Each Directory Record, irrespective of the Directory Entity it is included in, contains four types of information:

- a. A reference to a lower level Directory Entity or Referenced Directory Entity. This reference may be absent if such a lower level Directory Entity does not exist for an instance of a directory record;
- b. A reference to a File of the File-set in which is stored a "Referenced Object" (formally called in DICOM a Referenced SOP Instance). This reference may be absent if no File is referenced. Files may be referenced either directly by their File ID or indirectly through a Multi-Referenced File Directory Record. The latter case allows the same File to be referenced by several Directory Records;
- c. A set of "selection keys," specific to a Referenced Object, which will allow its selection among all the records included in a given Directory Entity;
- d. A mechanism to chain the various Directory Records which belong to the same Directory Entity.

This generic content of a Directory Record is further specialized based on its specific type in the context the Basic Directory IOD Information Model specified in Section F.4 (e.g., a Study Record, a Series Record, etc.). A Directory Entity may include Directory Records of different Types. By standardizing a number of specific Directory Records (see Section F.5) in the context of the Basic Directory IOD Information Model, one allows the definition of a variety of directory contents while maintaining a framework for interoperability.

Basic Directory Information Object

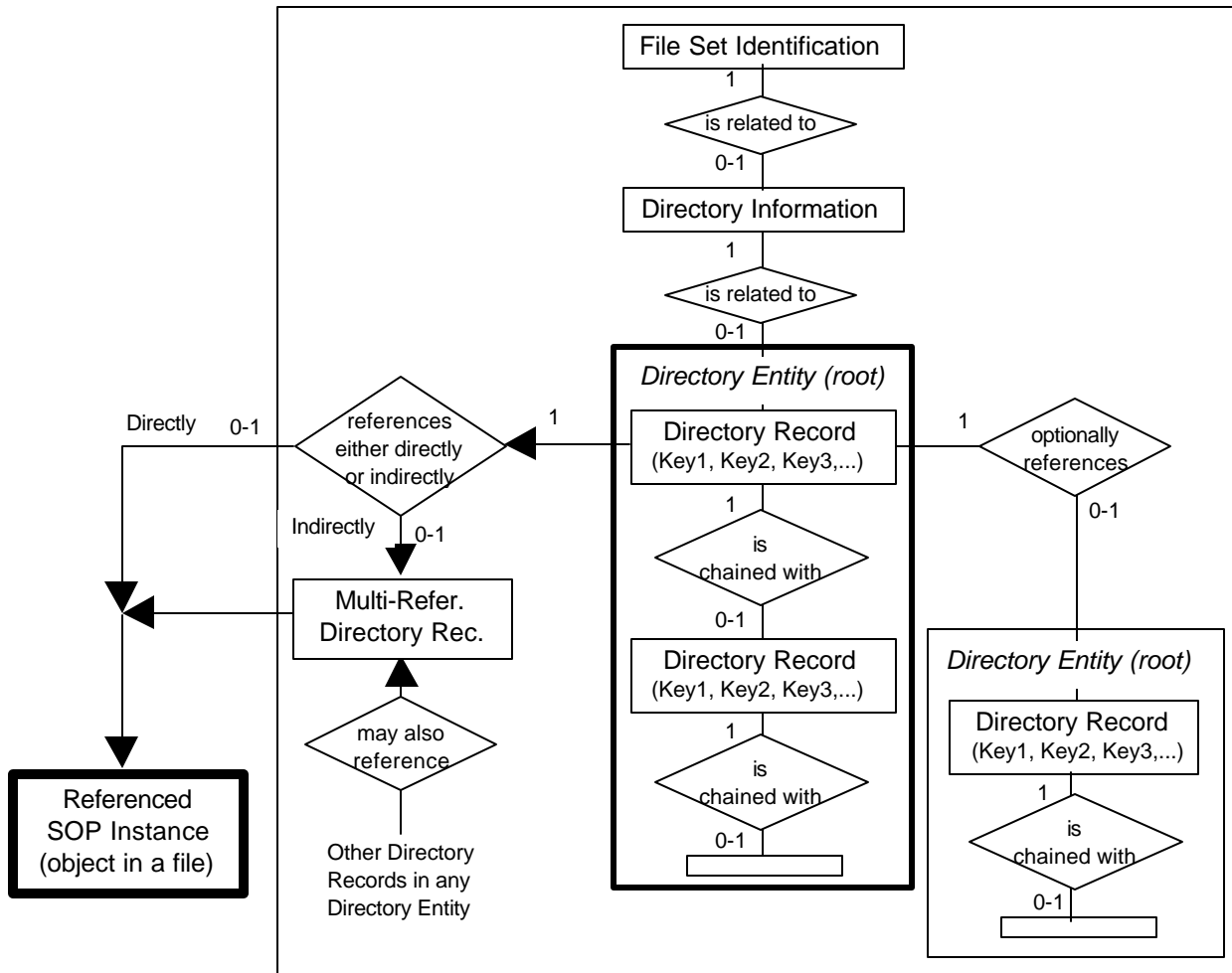

**Figure F.2-1
BASIC DIRECTORY INFORMATION OBJECT E-R MODEL**

To facilitate the management and update of the Directory Information a number of rules are defined:

- Any Lower-Level Directory Entity shall be referenced by at most one higher-level Directory Record. Not allowing multiple higher-level Directory Records to reference the same Lower-Level Directory Entity simplifies the management of the deletion (or inactivation) of Directory Records and Lower-Level Directory Entities and associated Directory Records
- Any Directory Record (except for MRDR) shall belong to a single Directory Entity. This rule and the above rule, makes the Basic Directory IOD itself strictly hierarchical
- All files referenced by a Directory shall be present in the same File-Set to which the directory belongs
- Non-DICOM files which are not referenced by the Directory may be included in the File-set space. The means of access to such Files and the semantics associated with their absence from the Directory is beyond the scope of the DICOM Standard

- e. If a DICOMDIR contains a Directory Information Module, all DICOM Files of the File-set shall be referenced by a Directory Record
- f. Any File of the File-set shall be directly referenced by at most one Directory Record of the Directory. Not allowing multiple Directory Records to directly reference the same File simplifies the management of the deletion of Directory Records and associated Files
- g. A single File may be referenced indirectly by several Directory Records (which may or may not belong to the same Directory Entity) through a special Directory Record (called a Multi-Referenced File Directory Record). Such a Directory Record facilitates the management of Directory Record deletion (or inactivation) by keeping an explicit count of the multiple references to a single File.

- Notes:
1. Despite the fact that rules a and b make the DICOM Directory strictly hierarchical, rules f and g make the referencing of Files fully relational. This relational flexibility allows the sharing of the content of referenced Files by different Directory Records (e.g. an image belonging to a study as well as a related film session). However, the full use of this flexibility may require the "cloning" of Directory Records due to the strict hierarchy of the Directory. An example of the use of a Multi-Referenced File Directory Record is shown in PS 3.10.
 2. Referenced Files may contain SOP Instances of SOP Classes which provide the means to reference by UIDs other SOP Instances which may not be stored in files of the same File-set (e.g. an image referencing a study component).

F.2.2 Example of a directory

The example provided in this Section is only one simple example of a possible directory content and organization. This Section is not normative in nature. Therefore, this example is not meant to specify a conformant directory nor to restrict the range of possible directory organizations supported by this Part of the DICOM Standard.

The overall organization is illustrated at a logical level in Section F.2.2.1. The actual structure of the content is discussed in Section F.2.2.2. Two Annexes of PS 3.10 provide example where further details of the encoding of the file content is depicted.

F.2.2.1 ILLUSTRATION OF THE OVERALL DIRECTORY ORGANIZATION

A simple directory content is used as an example of Directory organization. It is depicted by Figure F.2-2. The left hand side part of Figure F.2-2 depicts the various Objects stored in Files of the File-set. The right hand side presents an example of organization of the directory which facilitates access to the Files of the File-set.

This example shows how stored Files are referenced by Directory Records which are grouped into Directory Entities. The two Study Directory Records (Study 1 and Study 2) are part of the Directory Entity relative to the Patient A.

Thin curved lines depict the referencing mechanism based on File IDs which allow reference to Files containing stored objects. Thick curved lines depict the internal referencing mechanisms which support the reference to a lower-level Directory Entity by a Directory Record,.

Keys which are used to select a specific Directory Record from among the Directory Records of a Directory Entity are not shown on Figure F.2-2.

One may note in this example that certain Directory Records such as the Series Directory Records do not reference Files containing stored objects. Other Directory Records such as the Image Directory Records do not reference lower level Directory Entities. However, a number of Directory Records reference both one lower level Directory Entity and one File containing a stored object. This flexibility allows the definition of a variety of directories.

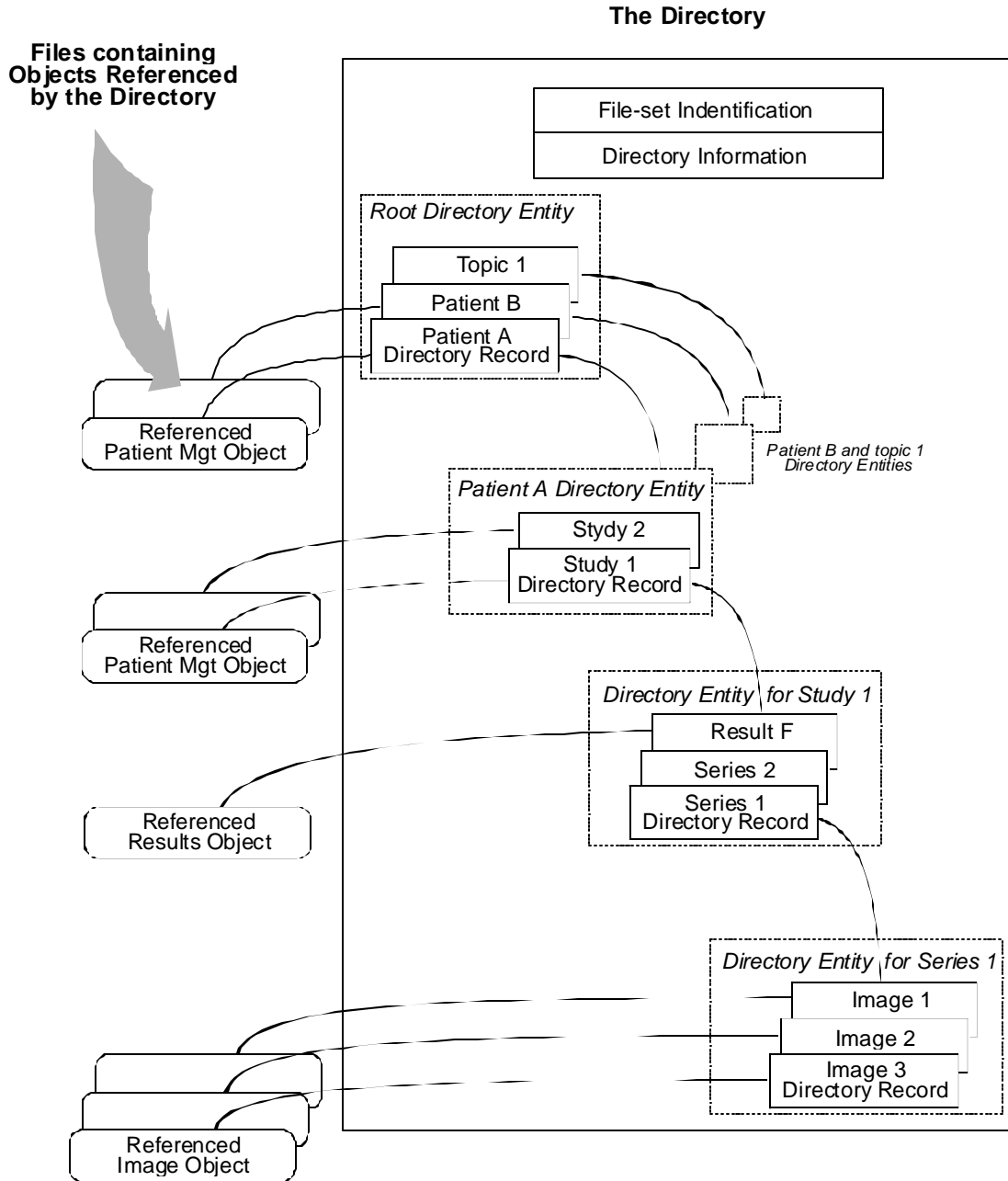

Figure F.2-2
EXAMPLE OF A DIRECTORY ORGANIZATION AND CONTENT

F.2.2.2 EXAMPLE OF A DICOM DIR FILE STRUCTURE

Based on the example discussed in Section F.2.2.1, the internal data structure used by the Basic Directory IOD is depicted in Figure F.2-3. It shows a set of Directory Records where each Directory Record is linked by three different types of "referencing" mechanisms:

- a. The chaining of Directory Records to form a Directory Entity. In particular, this facilitates the addition of new Directory Records at the level of any Directory Entity by placing them at the end of the DICOMDIR File. On Figure F.2-3, these chainings are shown by dotted lines:
 1. #1 shows the chaining of the Directory Records forming the root Directory Entity
 2. #2 shows the chaining of the Directory Records for the Directory Entity related to Patient A
 3. #3 shows the chaining of the Directory Records for the Directory Entity related to Study 1
 4. #4 shows the chaining of the Directory Records for the Directory Entity related to Series 1
- b. Thick curved lines depict the reference by a Directory Record to a lower level Directory Entity
- c. Thin curved lines depict the reference by a Directory Record to a stored file containing a SOP Class

This example of a DICOMDIR File structure shows one example of a specific order of the Directory Records. Other orderings of Directory Records could result in a functionally equivalent directory.

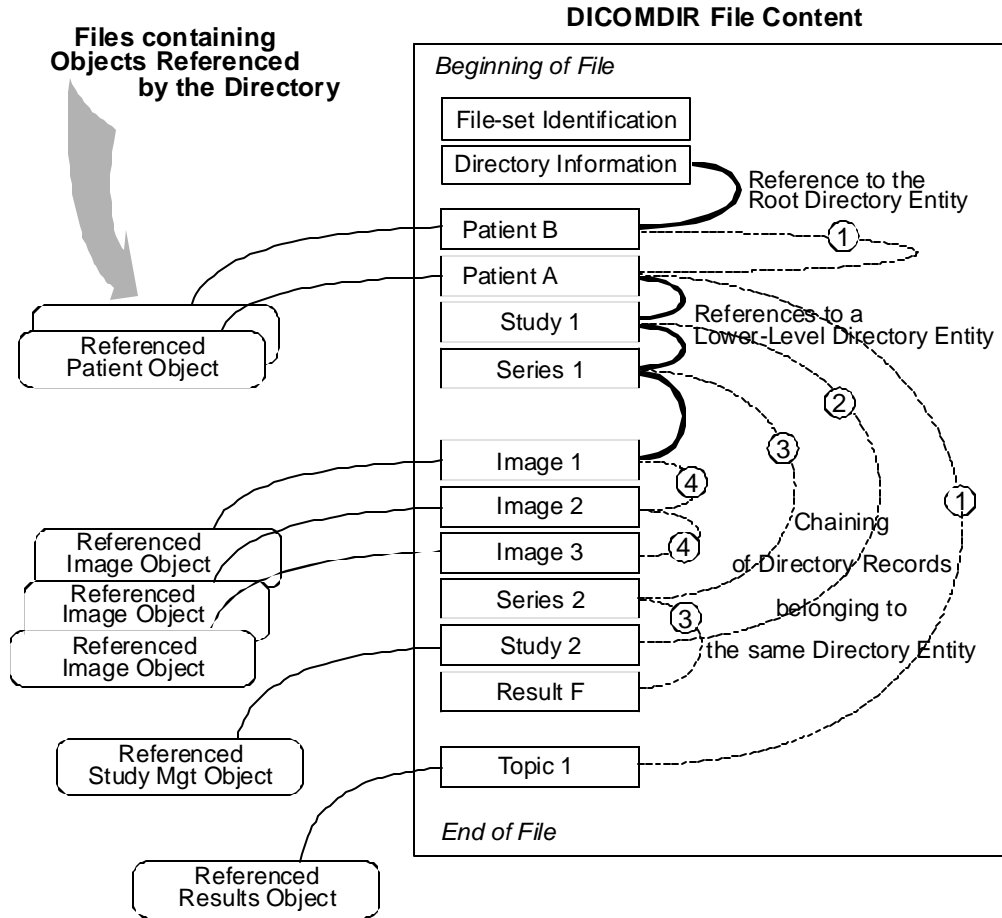

Figure F.2-3
EXAMPLE OF DATA STRUCTURE FOR THE DICOM DIRECTORY INFORMATION

F.3 BASIC DIRECTORY INFORMATION OBJECT DEFINITION

This IOD is based on the Directory Information organization introduced in Section F.2. The model for this Basic Directory IOD is described Section F.2.1 by the Entity/Relationship model in Figure F.2-1. The rules specified in Section F.2.1 apply to this Information Object Definition.

F.3.1 Module table

The Basic Directory IOD includes the Modules specified by Table F.3-1.

**Table F.3-1
BASIC DIRECTORY IOD MODULES**

Module	Reference	Usage	Module Description
File-set Identification	F.3.2.1	M	File-set identification information
Directory Information	F.3.2.2	U	Directory Information followed by a Sequence of Directory Records. Note: The Directory Information Module is optional. This Directory Information Module should be present in all but primitive environments where a directory is not needed. In this case, only the File-set Identification Information is present.

F.3.2 Modules of the basic directory information object

Attributes of the Basic Directory IOD are defined with a Type designation which indicates if a specific Attribute is required for all Media Storage Operations (See Section 5, Conventions).

F.3.2.1 FILE-SET IDENTIFICATION MODULE

**Table F.3-2
FILE-SET IDENTIFICATION MODULE**

Attribute Name	Tag	Type	Attribute Description
File-set ID	(0004,1130)	2	User or implementation specific Identifier (up to 16 characters). For definition, see PS 3.10. The File-set ID is intended to be a short human readable label to easily (but not necessarily uniquely) identify a specific File-set to facilitate operator manipulation of the physical media on which the File-set is stored. Assignment of Value and semantics are environment specific.
File-set Descriptor File ID	(0004,1141)	3	ID of a File (in the same File-set) used for user comments related to the File-set (e.g. a readme file). The Specific Character set used may be specified in the Specific Character Set of the File-set Descriptor File (0004,1142). Note: This File is not DICOM formatted (no Preamble, nor DICM Prefix and Meta Information).
Specific Character Set of File-set Descriptor File	(0004,1142)	1C	Character set used in the File-set Descriptor File with a File ID as specified in File-set Descriptor File ID (0004,1141). Required to specify the expanded or replacement character set. If absent, only the Basic Graphic set is used. See C.12.1.1.2 for Defined Terms.

Note: Every File-set is assigned a File-set UID when created. The File-set UID need not be duplicated as a Type 1 Attribute of the File-set Identification Module. It is conveyed as the SOP Instance UID of the Basic Directory IOD. It is included in the DICOMDIR File Meta Information (See PS 3.10)

F.3.2.2 DIRECTORY INFORMATION MODULE

This Module contains a sequence of Directory Records forming one or more Directory Entities. This Module defines at least one Directory Entity, the Root Directory Entity (which may be empty). Each Directory Record is composed of Directory Elements (marked by a ">"). They include:

- a. an offset pointer to another Directory Record of the Same Directory Entity
- b. an offset pointer to a lower level Directory Entity
- c. a Referenced File pointed to by the Directory Record
- d. a set of keys representative of the information contained in the Referenced File

**Table F.3-3
DIRECTORY INFORMATION MODULE**

Attribute Name	Tag	Type	Attribute Description
Offset of the First Directory Record of the Root Directory Entity	(0004,1200)	1	Offset of the first byte (of the Item Data Element) of the first Directory Record of the Root Directory Entity. This Offset is a number of bytes starting with the first byte of the File Meta Information. When the Root Directory Entity contains no Directory Record, this offset shall be set to 00000000H. Note: This offset includes the File Preamble and the DICM Prefix.
Offset of the Last Directory Record of the Root Directory Entity	(0004,1202)	1	Offset of the first byte (of the Item Data Element) of the last Directory Record of the Root Directory Entity. This Offset is a number of bytes starting with the first byte of the File Meta Information. When the Root Directory Entity contains no Directory Record, this offset shall be set to 00000000H. Note: This offset includes the File Preamble and the DICM Prefix.
File-set Consistency Flag	(0004,1212)	1	When set, this Flag indicates that an inconsistency within the Directory or between the Directory and the Files of the File-set may exist. Potential recovery actions are implementation specific and are beyond the scope of this Standard. Enumerated Values: 0000H: no known inconsistencies FFFFH: the FSR or FSU shall assume that inconsistencies are present. This flag shall be set by implementations before a File-set update which, if interrupted, may result in an inconsistent File-set. Note: There may be error conditions where an inconsistency is present but this flag is not set. There may also be conditions where no inconsistencies are present but the flag is set.

Directory Record Sequence	(0004,1220)	2	<p>Sequence of zero or more repeating Items where each Item contains a Directory Record by including the Directory Elements from (0004,1400) to (0004,1511) and Record selection Keys as defined below (marked with a >).</p> <p>A zero length Value indicates that no Directory Records are contained in the Root Directory Entity.</p>
>Offset of the Next Directory Record	(0004,1400)	1C	<p>Offset of the first byte (of the Item Data Element) of the next Directory Record of the same Directory Entity. This Offset is an unsigned integer representing a number of bytes starting with the first byte of the File Meta-information. A zero offset shall be used to mean that there is no other Directory Record in this Directory Entity.</p> <p>Required if the Directory Record Sequence (0004,1220) is not zero length.</p> <p>This Offset may be used to keep an inactive Record (0004,1410) chained with the next Directory Record of the same Directory Entity.</p> <p>Note: This offset includes the File Preamble and the DICM Prefix.</p>
>Record In-use Flag	(0004,1410)	1C	<p>This flag facilitates the deletion of referenced files.</p> <p>Enumerated Values:</p> <p>FFFFH = record is in use.</p> <p>0000H = record is inactive. All attributes of an inactive Directory Record except (0004,1400) and (0004,1410) shall be ignored.</p> <p>Other Values are reserved and shall not be set by File-set Creators, but if present shall be interpreted as FFFFH by File-set Readers or Updaters.</p> <p>Required if the Directory Record Sequence (0004,1220) is not zero length.</p> <p>If a Directory Record is changed from in use to inactive, the FSU shall ensure that all Directory Records of referenced lower-level Directory Entities are changed to inactive.</p>
>Offset of Referenced Lower-Level Directory Entity	(0004,1420)	1C	<p>Offset of the first byte (of the Item Data Element) of the first Directory Record of the Referenced Lower Level Directory Entity. This Offset is a number of bytes starting with the first byte of the File Meta Information. Required if the Directory Record Sequence (0004,1220) is not zero length. When no lower-level Directory Entity (containing at least one Directory Record) is referenced, this Attribute shall have a Value of 00000000H.</p> <p>Note: This offset includes the File Preamble and the DICM Prefix.</p>

<p>>Directory Record Type</p>	<p>(0004,1430)</p>	<p>1C</p>	<p>Defines a specialized type of Directory Record by reference to its position in the Media Storage Directory Information Model (see Section F.4).</p> <p>Required if the Directory Record Sequence (0004,1220) is not zero length.</p> <p>Enumerated Values (see Section F.5):</p> <table border="0"> <tr> <td>PATIENT</td> <td>STUDY</td> <td>SERIES</td> </tr> <tr> <td>IMAGE</td> <td>OVERLAY</td> <td>MODALITY LUT</td> </tr> <tr> <td>VOI LUT</td> <td>CURVE</td> <td>TOPIC</td> </tr> <tr> <td>VISIT</td> <td>RESULTS</td> <td>INTERPRETATION</td> </tr> <tr> <td>STUDY COMPONENT</td> <td></td> <td>STORED PRINT</td> </tr> <tr> <td>RT DOSE</td> <td>RT STRUCTURE SET</td> <td></td> </tr> <tr> <td>RT PLAN</td> <td>RT TREAT RECORD</td> <td></td> </tr> <tr> <td>PRESENTATION</td> <td></td> <td>WAVEFORM</td> </tr> <tr> <td>SR DOCUMENT</td> <td></td> <td>KEY OBJECT DOC</td> </tr> </table> <p>PRIVATE = Privately defined record hierarchy position. Type shall be defined by Private Record UID (0004,1432).</p> <p>MRDR = Special Directory Record which allows indirect reference to a File by multiple Directory Records. Instead of directly referencing a File by its Referenced File ID (0004,1500), a Directory Record of any of the Types define above (except MRDR) may reference a Multi-Referenced File Directory Record which in turn will reference the File by its File ID.</p> <p>Note: Enumerated Values PRINT QUEUE, FILM SESSION, FILM BOX, and IMAGE BOX were previously defined in DICOM for this Attribute. They are now retired. See PS3.3-1998.</p>	PATIENT	STUDY	SERIES	IMAGE	OVERLAY	MODALITY LUT	VOI LUT	CURVE	TOPIC	VISIT	RESULTS	INTERPRETATION	STUDY COMPONENT		STORED PRINT	RT DOSE	RT STRUCTURE SET		RT PLAN	RT TREAT RECORD		PRESENTATION		WAVEFORM	SR DOCUMENT		KEY OBJECT DOC
PATIENT	STUDY	SERIES																												
IMAGE	OVERLAY	MODALITY LUT																												
VOI LUT	CURVE	TOPIC																												
VISIT	RESULTS	INTERPRETATION																												
STUDY COMPONENT		STORED PRINT																												
RT DOSE	RT STRUCTURE SET																													
RT PLAN	RT TREAT RECORD																													
PRESENTATION		WAVEFORM																												
SR DOCUMENT		KEY OBJECT DOC																												
<p>>Private Record UID</p>	<p>(0004,1432)</p>	<p>1C</p>	<p>Required if the Directory Record Type (0004,1430) is of Value PRIVATE. This UID is used to define a non-standard type of Directory Record by reference to its position in a private extension to the Basic Directory IOD Information Model (see Section F.5). This UID shall be registered according to the procedures defined in PS 3.5. Its meaning may or may not be specified in a Conformance Statement.</p>																											

>Referenced File ID	(0004,1500)	1C	<p>A Multiple Value (See PS 3.5) which represents the ordered components of the File ID containing a "referenced object" or Referenced SOP Instance. A maximum of 8 components, each from 1 to 8 characters shall be used (see Section 8.2).</p> <p>Note: The Referenced File ID provides the means to "locate" the File through the DICOM File Service provided by the Media Format Layer.</p> <p>All referenced Files shall be with the File-set to which the Directory belongs. Any File within the File-set (to which the Directory belongs) shall be referenced by at most one Directory Record. When the Directory Record does not reference any SOP Instance this attribute shall not be present. To reference a single File by more than one Directory Record, a special Directory Record of Directory Record Type (0004,1430) MRDR is used. The Referenced File ID (0004,1500) shall be absent and the MRDR Directory Record Offset (0004, 1504) shall be used to reference the MRDR which indirectly references the File.</p>
>MRDR Directory Record Offset	(0004,1504)	1C	<p>Offset of the first byte (of the Item Data Element) of the Multi-Referenced File Directory Record. This Offset is a number of bytes starting with the first byte of the File Meta Information. When the Directory Record does not reference any SOP Instance this attribute shall not be present.</p> <p>Required if the Directory Record indirectly references a SOP Instance by a MRDR. Shall not be present if the Referenced File ID (0004,1500) is used for direct reference.</p> <p>Shall not be present in a Multi-Referenced File Directory Record.</p> <p>Note: This offset includes the File Preamble and the DICM Prefix.</p>
>Referenced SOP Class UID in File	(0004,1510)	1C	<p>Unique ID for the SOP Class related to the IOD stored in the referenced File. This UID shall be present whether the File is referenced directly by Referenced File ID (0004,1500) or indirectly by an MRDR Directory Record Offset (0004,1504).</p> <p>Required only if the Directory Record references a SOP Instance. Shall not be used in a Multi-Referenced File Directory Record.</p>
>Referenced SOP Instance UID in File	(0004,1511)	1C	<p>Unique Identifier for the SOP Instance related to the IOD stored in the referenced file. This UID shall be present whether the File is referenced directly by Referenced File ID (0004,1500) or indirectly by an MRDR Directory Record Offset.</p> <p>Required only if the Directory Record references a SOP Instance. Shall not be used in a Multi-Referenced File Directory Record.</p>
>Referenced Transfer Syntax UID in File	(0004,1512)	1C	<p>Unique Identifier for the Transfer Syntax used to encode the IOD stored in the referenced file. This UID shall be present whether the File is referenced directly by Referenced File ID (0004,1500) or indirectly by an MRDR Directory Record Offset.</p> <p>Required only if the Directory Record references a SOP Instance. Shall not be used in a Multi-Referenced File Directory Record.</p>

>Record Selection Keys	See F.5	See F.5	A number of DICOM Data Elements which contain specific keys defined for each type of Directory Record (0004,1430) defined in Section F.5.
------------------------	---------	---------	---

F.4 BASIC DIRECTORY IOD INFORMATION MODEL

The Basic Directory IOD Information Model defines the relationship between the various types of Directory Records which may be used in constructing DICOM Directories. This model is based on the DICOM Application Model defined in this part of the DICOM Standard. Entities in this Model correspond to Directory Records (DR). These are shown as rectangular boxes. Each Directory Record in this model is part of a Directory Entity (not shown except for the Root Entity) which is referenced by a Directory Record of a higher-level Directory Entity (e.g., a Study Directory Record references a Directory Entity which includes Directory Records describing the content of the Study).

Each Directory Record has a number of mandatory and optional keys which are not shown on this model. They are defined in Section F.5. Conventions used are those used by this part of the DICOM Standard. The model is depicted as an entity/relationship model in Figure F.4-1. These Directory Record relationships are fully specified in Table F.4-1.

**Table F.4-1
RELATIONSHIP BETWEEN DIRECTORY RECORDS**

Directory Record Type	Section	Directory Record Types which may be included in the next lower-level directory Entity
(Root Directory Entity)	—	PATIENT, TOPIC, PRIVATE
PATIENT	F.5.1	STUDY, PRIVATE
STUDY	F.5.2	SERIES, VISIT, RESULTS, STUDY COMPONENT PRIVATE
SERIES	F.5.3	IMAGE, OVERLAY, MODALITY LUT, VOI LUT, CURVE, STORED PRINT, RT DOSE, RT STRUCTURE SET, RT PLAN, RT TREAT RECORD, PRESENTATION, WAVEFORM, SR DOCUMENT, KEY OBJECT DOC, PRIVATE
IMAGE	F.5.4	PRIVATE
OVERLAY	F.5.5	PRIVATE
MODALITY LUT	F.5.6	PRIVATE
VOI LUT	F.5.7	PRIVATE
CURVE	F.5.8	PRIVATE
STORED PRINT	F.5.18	PRIVATE
RT DOSE	F.5.19	PRIVATE
RT STRUCTURE SET	F.5.20	PRIVATE
RT PLAN	F.5.21	PRIVATE
RT TREAT RECORD	F.5.22	PRIVATE
PRESENTATION	F.5.23	PRIVATE
WAVEFORM	F.5.24	PRIVATE

SR DOCUMENT	F.5.25	PRIVATE
KEY OBJECT DOC	F.5.26	PRIVATE
TOPIC	F.5.9	STUDY, SERIES, IMAGE, OVERLAY, MODALITY LUT, VOI LUT, CURVE, STORED PRINT, RT DOSE, RT STRUCTURE SET, RT PLAN, RT TREAT RECORD, PRESENTATION, WAVEFORM, SR DOCUMENT, KEY OBJECT DOC, PRIVATE
VISIT	F.5.10	PRIVATE
RESULTS	F.5.11	INTERPRETATION, PRIVATE
INTERPRETATION	F.5.12	PRIVATE
STUDY COMPONENT	F.5.13	PRIVATE
PRIVATE	F.6.1	PRIVATE, (any of the above as privately defined)
MRDR	F.6.2	(Not applicable)

Note: Directory Record Types PRINT QUEUE, FILM SESSION, FILM BOX, and IMAGE BOX were previously defined in DICOM. They have been retired. See PS 3.3-1998.

F.5 DEFINITION OF SPECIFIC DIRECTORY RECORDS

The following Sections specify a number of Directory Records which were introduced by the Basic Directory IOD Information Model presented in Section F.4. For each one, it identifies the SOP Classes which may be referenced and the related mandatory keys. Keys are assigned a Type designation which indicates if it is required for all Media Storage Operations of the Directory (See Section 5, Conventions).

Type 2 and Type 3 Keys may be changed to Type 1 and Type 2 or 3 respectively by Application Profiles defined in PS 3.11 of the DICOM standard. Keys based on Private Data Elements, or Private Keys may also be used in addition to Standard defined Keys. However such Private keys may be ignored by any File-set Reader or Updater.

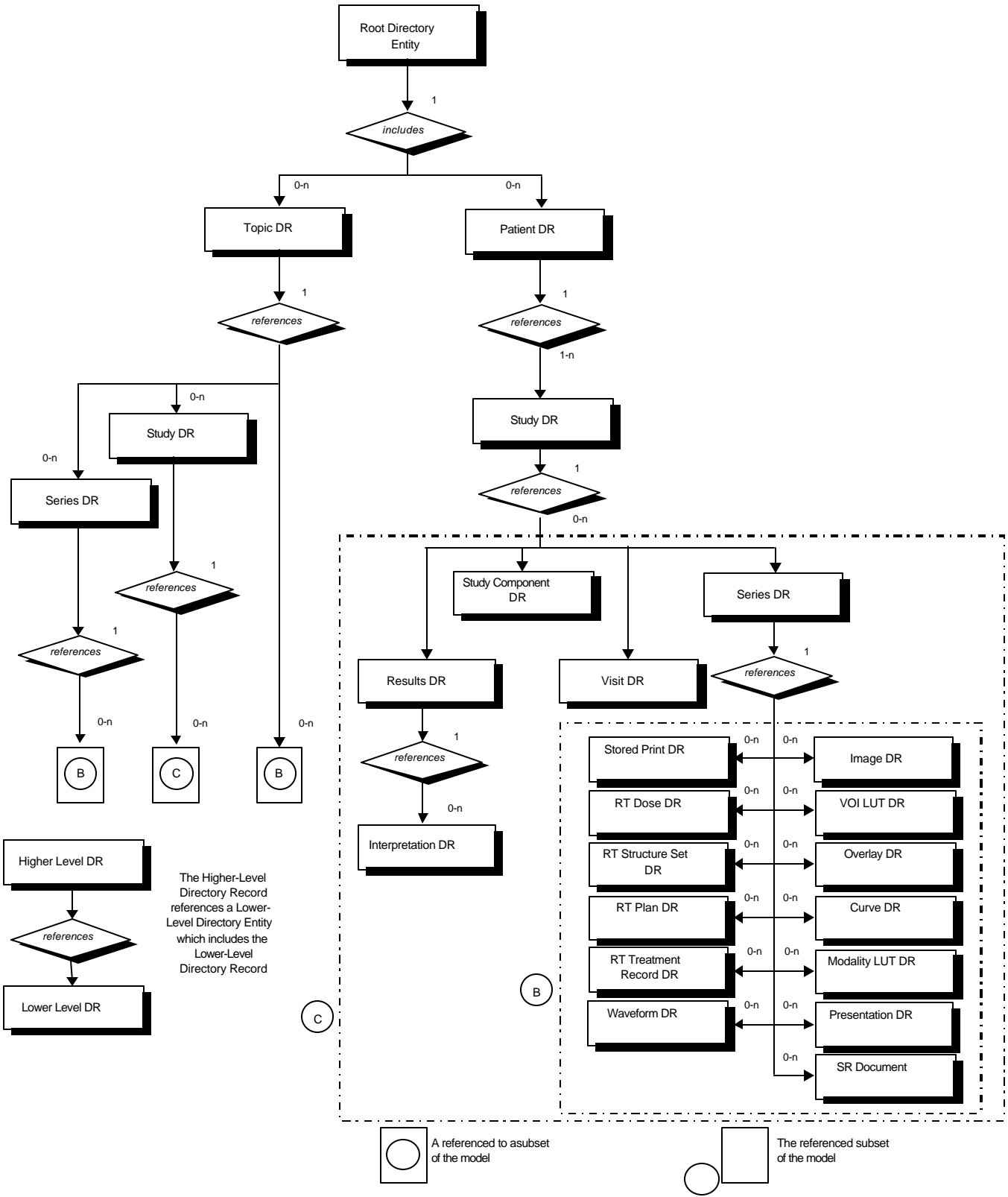

**Figure F.4-1
BASIC DIRECTORY IOD INFORMATION MODEL**

Note: Normalized Print media storage was previously defined in DICOM. It is now retired. See PS3.3 -1998.

F.5.1 Patient Directory Record Definition

The Directory Record is based on the specification of Section F.3. It is identified by a Directory Record Type of Value "PATIENT." Table F.5-1 lists the set of keys with their associated Types for such a Directory Record Type. The description of these keys may be found in the Modules related to the Patient IOD or the Patient IE of Image IODs. This Directory Record shall be used to reference a Detached Patient Management SOP Instance. This Type of Directory Record may reference a Lower-Level Directory Entity which includes one or more Directory Records as defined in Table F.4-2.

**Table F.5-1
PATIENT KEYS**

Key	Tag	Type	Attribute Description
Specific Character Set	(0008,0005)	1C	Required if an extended or replacement character set is used in one of the keys
Patient's Name	(0010,0010)	2	
Patient ID	(0010,0020)	1	
Any other Attribute of the Patient IOD or Patient IE Modules		3	

For a given File-set, the Patient ID shall be unique. This means that it shall not appear in different Patient Directory Records.

F.5.2 Study Directory record definition

The Directory Record is based on the specification of Section F.3. It is identified by a Directory Record Type of Value "STUDY." Table F.5-2 lists the set of keys with their associated Types for such a Directory Record Type. The description of these keys may be found in the Modules related to the Study IOD or the Study IE of Image IODs. This Directory Record shall be used to reference a Detached Study Management SOP Instance. This Type of Directory Record may reference a Lower-Level Directory Entity which includes one or more Directory Records as defined in Table F.4-2.

**Table F.5-2
STUDY KEYS**

Key	Tag	Type	Attribute Description
Specific Character Set	(0008,0005)	1C	Required if an extended or replacement character set is used in one of the keys
Study Date	(0008,0020)	1	
Study Time	(0008,0030)	1	
Study Description	(0008,1030)	2	
Study Instance UID	(0020,000D)	1C	Required only if (0004,1511) is absent. (See Note)
Study ID	(0020,0010)	1	
Accession Number	(0008,0050)	2	
Any other Attribute of the Study IOD or Study IE Modules		3	

Note: The Study Instance UID shall be present as a mandatory key only if no file is referenced by this Directory Record. In the case where this Directory Record references a file, the Directory Record contains in the Referenced SOP Instance UID in File (0004,1511). In this case (0004,1511) may be used as a "pseudo" Directory Record Key (See Table F.3-3) and need not be duplicated.

F.5.3 Series Directory Record Definition

The Directory Record is based on the specification of Section F.3. It is identified by a Directory Record Type of Value "SERIES." Table F.5-3 lists the set of keys with their associated Types for such a Directory Record Type. The description of these keys may be found in the Modules related to the Series IE and Equipment IE of Image IODs. This type of Directory Record may reference a Lower-Level Directory Entity which includes one or more Directory Records as defined in Table F.4-2.

**Table F.5-3
SERIES KEYS**

Key	Tag	Type	Attribute Description
Specific Character Set	(0008,0005)	1C	Required if an extended or replacement character set is used in one of the keys
Modality	(0008,0060)	1	
Series Instance UID	(0020,000E)	1	
Series Number	(0020,0011)	1	
Icon Image Sequence	(0088,0200)	3	This Icon Image is representative of the Series. It may or may not correspond to one of the images of the Series.
>Image Pixel Module			See Section F.7 of this Part.
Any other Attribute of the Series IE Modules		3	

F.5.4 Image directory record definition

The Directory Record is based on the specification of Section F.3. It is identified by a Directory Record Type of Value "IMAGE." Table F.5-4 lists the set of keys with their associated Types for such a Directory Record Type. The description of these keys may be found in the Modules related to the Image IE of Image IODs. This Directory Record shall be used to reference an Image SOP Instance. This type of Directory Record may reference a Lower-Level Directory Entity which includes one or more Directory Records as defined in Table F.4-2.

**Table F.5-4
IMAGE KEYS**

Key	Tag	Type	Attribute Description
Specific Character Set	(0008,0005)	1C	Required if an extended or replacement character set is used in one of the keys.
Instance Number	(0020,0013)	1	
Icon Image Sequence	(0088,0200)	3	This Icon Image is representative of the Image.
>Image Pixel Module			See Section F.7 of this Part.
Any other Attribute of the Image IE Modules		3	

Note: Because (0004,1511) Referenced SOP Instance UID in File may be used as a "pseudo" Directory Record Key (See Table F.3-3), it is not duplicated in this list of keys.

F.5.5 Standalone overlay directory record definition

The Directory Record is based on the specification of Section F.3. It is identified by a Directory Record Type of Value "OVERLAY." Table F.5-5 lists the set of keys with their associated Types for such a Directory Record Type. The description of these keys may be found in the Modules related to the Overlay IE of Image IODs. This Directory Record shall be used to reference a Standalone Overlay Image SOP Instance. This Type of Directory Record may reference a Lower-Level Directory Entity which includes one or more Directory Records as defined in Table F.4-2.

**Table F.5-5
OVERLAY KEYS**

Key	Tag	Type	Attribute Description
Specific Character Set	(0008,0005)	1C	Required if an extended or replacement character set is used in one of the keys.
Overlay Number	(0020,0022)	1	
Icon Image Sequence	(0088,0200)	3	
>Image Pixel Module			See Section F.7 of this Part.
Any other Attribute of the Overlay IE Modules		3	

Note: Because (0004,1511) Referenced SOP Instance UID in File may be used as a "pseudo" Directory Record Key (See Table F.3-3), it is not duplicated in this list of keys.

F.5.6 Standalone modality LUT directory record definition

The Directory Record is based on the specification of Section F.3. It is identified by a Directory Record Type of Value "MODALITY LUT." Table F.5-6 lists the set of keys with their associated Types for such a Directory Record Type. The description of these keys may be found in the Modules related to the Modality LUT IE of Image IODs. This Directory Record shall be used to reference a Standalone Modality LUT SOP Instance. This Type of Directory Record may reference a Lower-Level Directory Entity which includes one or more Directory Records as defined in Table F.4-2.

**Table F.5-6
Modality LUT Keys**

Key	Tag	Type	Attribute Description
Specific Character Set	(0008,0005)	1C	Required if an extended or replacement character set is used in one of the keys.
Lookup table Number	(0020,0026)	1	
Any other Attribute of the Modality LUT IE Modules		3	

Note: Because (0004,1511) Referenced SOP Instance UID in File may be used as a "pseudo" Directory Record Key (See Table F.3-3), it is not duplicated in this list of keys.

F.5.7 Standalone VOI LUT directory record definition

The Directory Record is based on the specification of Section F.3. It is identified by a Directory Record Type of Value "VOI LUT." Table F.5-7 lists the set of keys with their associated Types for such a Directory Record Type. The description of these keys may be found in the Modules related to the VOI LUT IE of Image IODs. This Directory Record shall be used to reference a Standalone VOI LUT SOP Instance. This Type of Directory Record may reference a Lower-Level Directory Entity which includes one or more Directory Records as defined in Table F.4-2.

**Table F.5-7
VOI LUT KEYS**

Key	Tag	Type	Attribute Description
Specific Character Set	(0008,0005)	1C	Required if an extended or replacement character set is used in one of the keys)
Lookup Table Number	(0020,0026)	1	
Any other Attribute of the VOI LUT IE Modules		3	

Note: Because (0004,1511) Referenced SOP Instance UID in File may be used as a "pseudo" Directory Record Key (See Table F.3-3), it is not duplicated in this list of keys.

F.5.8 Standalone curve directory record definition

The Directory Record is based on the specification of Section F.3. It is identified by a Directory Record Type of Value "CURVE." Table F.5-8 lists the set of keys with their associated Types for such a Directory Record Type. The description of these keys may be found in the Modules related to the Curve IE of Image IODs. This Directory Record shall be used to reference a Standalone Curve SOP Instance. This Type of Directory Record may reference a Lower-Level Directory Entity which includes one or more Directory Records as defined in Table F.4-2.

**Table F.5-8
CURVE KEYS**

Key	Tag	Type	Attribute Description
Specific Character Set	(0008,0005)	1C	Required if an extended or replacement character set is used in one of the keys.
Curve Number	(0020,0024)	1	
Any other Attribute of the Curve IE Modules		3	

Note: Because (0004,1511) Referenced SOP Instance UID in File may be used as a "pseudo" Directory Record Key (See Table F.3-3), it is not duplicated in this list of keys.

F.5.9 Topic directory record definition

The Topic Directory Record is intended to collect a set of subordinate Directory Records. It uses simple textual descriptions as keys. The Directory Record is based on the specification of Section F.3. It is identified by a Directory Record Type of Value "TOPIC." Table F.5-9 lists the set of keys with their associated Types for such a Directory Record Type. This Type of Directory Record may reference a Lower-Level Directory Entity which includes one or more Directory Records as defined in Table F.4-2.

**Table F.5-9
TOPIC KEYS**

Key	Tag	Type	Attribute Description
Specific Character Set	(0008,0005)	1C	Required if an extended or replacement character set is used
Topic Title	(0088,0904)	1	Text title for the topic addressed by this Directory Record
Topic Subject	(0088,0906)	2	Short Text description of the subject addressed by this topic
Topic Author	(0088,0910)	2	Name of the author or creator of this topic
Topic Key Words	(0088,0912)	2	A multiple Value field including from 1 to 32 key-words related to the topic.

Note: For more complex Directory Records with additional keys, a PRIVATE Directory Record is suggested rather than a Topic Directory Record.

F.5.10 Visit directory record definition

The Directory Record is based on the specification of Section F.3. It is identified by a Directory Record Type of Value "VISIT." Table F.5-10 lists the set of keys with their associated Types for such a Directory Record Type. The description of these keys may be found in the Modules related to the Visit IOD. This Directory Record shall be used to reference a Detached Visit Management SOP Instance. This Type of Directory Record may reference a Lower-Level Directory Entity which includes one or more Directory Records as defined in Table F.4-2.

**Table F.5-10
VISIT KEYS**

Key	Tag	Type	Attribute Description
Admitting Date	(0038,0020)	2	
Admission ID	(0038,0010)	2	
Institution Name	(0008,0080)	2	
Specific Character Set	(0008,0005)	1C	Required if an extended or replacement character set is used in one of the keys
Any other Attribute of the Visit IOD Modules		3	

Note: Because (0004,1511) Referenced SOP Instance UID in File may be used as a "pseudo" Directory Record Key (See Table F.3-3), it is not duplicated in this list of keys.

F.5.11 Results directory record definition

The Directory Record is based on the specification of Section F.3. It is identified by a Directory Record Type of Value "RESULTS." Table F.5-11 lists the set of keys with their associated Types for such a Directory Record Type. The description of these keys may be found in the Modules related to the Results IOD. This Directory Record shall be used to reference a Detached Results Management SOP Instance. This Type of Directory Record may reference a Lower-Level Directory Entity which includes one or more Directory Records as defined in Table F.4-2.

**Table F.5-11
RESULT KEYS**

Key	Tag	Type	Attribute Description
Results ID	(4008,0040)	2	
Instance Creation date (Results)	(0008,0012)	2	
Specific Character Set	(0008,0005)	1C	Required if an extended or replacement character set is used in one of the keys)
Any other Attribute of the Results IOD Modules		3	

Note: Because (0004,1511) Referenced SOP Instance UID in File may be used as a "pseudo" Directory Record Key (See Table F.3-3), it is not duplicated in this list of keys.

F.5.12 Interpretation directory record definition

The Directory Record is based on the specification of Section F.3. It is identified by a Directory Record Type of Value "INTERPRETATION." Table F.5-12 lists the set of keys with their associated Types for such a Directory Record Type. The description of these keys may be found in the Modules related to the Interpretation IOD. This Directory Record shall be used to reference an Interpretation SOP Instance. This Type of Directory Record may reference a Lower-Level Directory Entity which includes one or more Directory Records as defined in Table F.4-2.

**Table F.5-12
INTERPRETATION KEYS**

Key	Tag	Type	Attribute Description
Specific Character Set	(0008,0005)	1C	Required if an extended or replacement character set is used in one of the keys
Interpretation Transcription Date	(4008,0108)	1	
Interpretation Author	(4008,010C)	2	
Interpretation Diagnosis Description	(4008,0115)	2	
Interpretation Diagnosis Codes Sequence	(4008,0117)	2	
>Code Value	(0008,0100)	1C	Required if (4008,0117) is present
>Coding Scheme Designator	(0008,0102)	1C	Required if (4008,0117) is present
>Code Meaning	(0008,0104)	1C	Required if (4008,0117) is present
Interpretation ID	(4008,0200)	1	
Interpretation Type ID	(4008,0210)	2	

Interpretation Status ID	(4008,0212)	2	
Any Attribute of Interpretation related Modules		3	

Note: Because (0004,1511) Referenced SOP Instance UID in File may be used as a "pseudo" Directory Record Key (See Table F.3-3), it is not duplicated in this list of keys.

F.5.13 Study component directory record definition

The Directory Record is based on the specification of Section F.3. It is identified by a Directory Record Type of Value "STUDY COMPONENT." Table F.5-13 lists the set of keys with their associated Types for such a Directory Record Type. The description of these keys may be found in the Modules related to the Study Component IOD. This Directory Record shall be used to reference a Study Component SOP Instance. This Type of Directory Record may reference a Lower-Level Directory Entity which includes one or more Directory Records as defined in Table F.4-2.

**Table F.5-13
STUDY COMPONENT KEYS**

Key	Tag	Type	Attribute Description
Specific Character Set	(0008,0005)	1C	Required if an extended or replacement character set is used in one of the keys
Modality	(0008,0060)	1	
Study Description	(0008,1030)	2	
Procedure Code Sequence	(0008,1032)	1	
> Code Value	(0008,0100)	1C	Required if (0008,1032) is present
> Coding Scheme Designator	(0008,0102)	1C	Required if (0008,1032) is present
> Code Meaning	(0008,0104)	1C	Required if (0008,1032) is present
Performing Physician's Name	(0008,1050)	2	
Any Attribute of Study Component Modules		3	

Note: Because (0004,1511) Referenced SOP Instance UID in File may be used as a "pseudo" Directory Record Key (See Table F.3-3), it is not duplicated in this list of keys.

F.5.14 Print Queue Directory Record Definition

This section was previously defined in DICOM. It is now retired. See PS 3.3-1998.

F.5.15 Film session directory record definition

This section was previously defined in DICOM. It is now retired. See PS 3.3-1998.

F.5.16 Film box directory record definition

This section was previously defined in DICOM. It is now retired. See PS 3.3-1998.

F.5.17 Basic image box directory record definition

This section was previously defined in DICOM. It is now retired. See PS 3.3-1998.

F.5.18 Stored Print Directory Record Definition

The Directory Record is based on the specification of Section F.3. It is identified by a Directory Record Type of Value "STORED PRINT". Table F.5-18 lists the set of keys with their associated Types for such a Directory Record Type. The description of these keys may be found in the Modules related to Stored Print IODs. This Directory Record shall be used to reference a Stored Print SOP Instance. This Type of Directory Record may reference a Lower-Level Directory Entity which includes one or more Directory Records as defined in Table F.4-2.

**Table F.5-18
STORED PRINT KEYS**

Key	Tag	Type	Attribute Description
Specific Character Set	(0008,0005)	1C	Required if an extended or replacement character set is used in one of the keys.
Instance Number	(0020,0013)	2	A number that identifies this film box.
Icon Image Sequence	(0088,0200)	3	One or more Icons which represent the images (of the Film Box) which are referenced by the Stored Print SOP instance.
> Image Pixel Module			See Section F.7 of this Part.
Any other Attribute of the Image IE Modules		3	

Note: Because (0004,1511) Referenced SOP Instance UID in File may be used as a "pseudo" Directory Record Key (See Table F.3-3), it is not duplicated in this list of keys.

F.5.19 RT Dose Directory Record Definition

This Directory Record is based on the specification of Section F.3. It is identified by a Directory Record Type of Value "RT DOSE". Table F.5-19 lists the set of keys with their associated Types for such a Directory Record Type. The description of these keys may be found in the Modules related to the Dose IE of the RT Dose IOD. This Directory Record shall be used to reference a RT Dose SOP instance. This Type of Directory Record may reference a Lower-Level Directory Entity which includes one or more Directory Records as defined in Table F.4-2.

**Table F.5-19
RT DOSE KEYS**

Key	Tag	Type	Attribute Description
Specific Character Set	(0008,0005)	1C	Required if an extended or replacement character set is used in one of the keys.
Instance Number	(0020,0013)	1	
Dose Summation Type	(3004,000A)	1	
Dose Comment	(3004,0006)	3	
Icon Image Sequence	(0088,0200)	3	This Icon Image is representative of the RT Dose.
>Image Pixel Module			See Section F.7 of this part.
Any other Attribute of the Dose IE Modules		3	

Note: Because (0004,1511) Referenced SOP Instance UID in File may be used as a "pseudo" Directory Record Key (see Table F.3-3), it is not duplicated in this list of keys.

F.5.20 RT Structure Set Directory Record Definition

This Directory Record is based on the specification of Section F.3. It is identified by a Directory Record Type of Value "RT STRUCTURE SET". Table F.5-20 lists the set of keys with their associated Types for such a Directory Record Type. The description of these keys may be found in the Modules related to the Structure Set IE of the RT Structure Set IOD. This Directory Record shall be used to reference a RT Structure Set SOP instance. This Type of Directory Record may reference a Lower-Level Directory Entity which includes one or more Directory Records as defined in Table F.4-2.

**Table F.5-20
RT STRUCTURE SET KEYS**

Key	Tag	Type	Attribute Description
Specific Character Set	(0008,0005)	1C	Required if an extended or replacement character set is used in one of the keys.
Instance Number	(0020,0013)	1	
Structure Set Label	(3006,0002)	1	
Structure Set Date	(3006,0008)	2	
Structure Set Time	(3006,0009)	2	
Any other Attribute of the Structure Set IE Modules		3	

Note: Because (0004,1511) Referenced SOP Instance UID in File may be used as a "pseudo" Directory Record Key (see Table F.3-3), it is not duplicated in this list of keys.

F.5.21 RT Plan Directory Record Definition

This Directory Record is based on the specification of Section F.3. It is identified by a Directory Record Type of Value "RT PLAN". Table F.5-21 lists the set of keys with their associated Types for such a Directory Record Type. The description of these keys may be found in the Modules related to the Plan IE of the RT Plan IOD. This Directory Record shall be used to reference a RT Plan SOP instance. This Type of Directory Record may reference a Lower-Level Directory Entity which includes one or more Directory Records as defined in Table F.4-2.

**Table F.5-21
RT PLAN KEYS**

Key	Tag	Type	Attribute Description
Specific Character Set	(0008,0005)	1C	Required if an extended or replacement character set is used in one of the keys
Instance Number	(0020,0013)	1	
RT Plan Label	(300A,0002)	1	
RT Plan Date	(300A,0006)	2	
RT Plan Time	(300A,0007)	2	
Any other Attribute of the Plan IE Modules		3	

Note: Because (0004,1511) Referenced SOP Instance UID in File may be used as a "pseudo" Directory Record Key (see Table F.3-3), it is not duplicated in this list of keys.

F.5.22 RT Treatment Record Directory Record Definition

This Directory Record is based on the specification of Section F.3. It is identified by a Directory Record Type of Value "RT TREAT RECORD". Table F.5-22 lists the set of keys with their associated Types for such a Directory Record Type. The description of these keys may be found in the Modules related to the Treatment Record IE of the RT Treatment Record IODs. This Directory Record shall be used to reference an RT Beams Treatment Record SOP instance, RT Brachy Treatment Record SOP instance, or RT Treatment Summary Record SOP instance. This Type of Directory Record may reference a Lower-Level Directory Entity which includes one or more Directory Records as defined in Table F.4-2.

**Table F.5-22
RT TREATMENT RECORD KEYS**

Key	Tag	Type	Attribute Description
Specific Character Set	(0008,0005)	1C	Required if an extended or replacement character set is used in one of the keys
Instance Number	(0020,0013)	1	
Treatment Date	(3008,0250)	2	
Treatment Time	(3008,0251)	2	
Any other Attribute of the Treatment Record IE Modules		3	

Note: Because (0004,1511) Referenced SOP Instance UID in File may be used as a "pseudo" Directory Record Key (see Table F.3-3), it is not duplicated in this list of keys.

F.5.23 Presentation State Directory Record Definition

The Directory Record is based on the specification of Section F.3. It is identified by a Directory Record Type of Value "PRESENTATION". Table F.5-23 lists the set of keys with their associated Types for such a Directory Record Type. The description of these keys may be found in the Modules related to Grayscale Softcopy Presentation State Storage IODs. This Directory Record shall be used to reference a Grayscale Softcopy Presentation State Storage SOP Instance. This Type of Directory Record may reference a Lower-Level Directory Entity which includes one or more Directory Records as defined in Table F.4-2.

**Table F.5-23
PRESENTATION KEYS**

Key	Tag	Type	Attribute Description
Specific Character Set	(0008,0005)	1C	Required if an extended or replacement character set is used in one of the keys.
Instance Number	(0020,0013)	1	A number that identifies this presentation state.
Presentation Label	(0070,0080)	1	A label that is used to identify this presentation.
Presentation Description	(0070,0081)	2	A description of this presentation.

Presentation Creation Date	(0070,0082)	1	Date on which this presentation was created. Note: This date may be different from the date that the DICOM SOP Instance was created, since the presentation state information contained may have been recorded earlier.
Presentation Creation Time	(0070,0083)	1	Time at which this presentation was created. Note: This time may be different from the time that the DICOM SOP Instance was created, since the presentation state information contained may have been recorded earlier.
Presentation Creator's Name	(0070,0084)	2	Name of operator saving the presentation state (such as a technologist or physician).
Referenced Series Sequence	(0008,1115)	1	Sequence of Repeating Items where each Item includes the Attributes of one or more Series.
>Series Instance UID	(0020,000E)	1C	Unique identifier of a Series that is part of this Study. Required if sequence item is present.
>Referenced Image Sequence	(0008,1140)	1C	Sequence of Repeating Items where each Item provides reference to a selected set of Image SOP Class/SOP Instance pairs that are part of this Study and the Series defined by Series Instance UID (0020,000E). Required if a sequence item is present.
>>Referenced SOP Class UID	(0008,1150)	1C	Uniquely identifies the referenced SOP Class. Required if sequence item is present. Shall be the same for all Images referenced by this presentation state.
>>Referenced SOP Instance UID	(0008,1155)	1C	Uniquely identifies the referenced SOP Instance. Required if sequence item is present.
Any other Attribute of the Presentation IE Modules		3	

Note: Because (0004,1511) Referenced SOP Instance UID in File may be used as a "pseudo" Directory Record Key (See Table F.3-3), it is not duplicated in this list of keys.

F.5.24 Waveform_Directory Record Definition

The Directory Record is based on the specification of Section F.3. It is identified by a Directory Record Type of Value "WAVEFORM". Table F.5-24 lists the set of keys with their associated Types for such a Directory Record Type. The description of these keys may be found in PS 3.3 of the DICOM Standard in the Modules related to the Waveform_IE. This Directory Record shall be used to reference a Waveform_SOP Instance. This Type of Directory Record may reference a Lower-Level Directory Entity which includes one or more Directory Records as defined in Table F.4-2.

**Table F.5-24
WAVEFORM KEYS**

Key	Tag	Type	Attribute Description
Specific Character Set	(0008,0005)	1C	Required if an extended or replacement character set is used in one of the keys.

Instance Number	(0020,0013)	1	
Content Date	(0008,0023)	1	
Content Time	(0008,0033)	1	
Any other Attribute of the Waveform IE Modules		3	

Note: Because (0004,1511) Referenced SOP Instance UID in File may be used as a "pseudo" Directory Record Key (See Table F.3-3), it is not duplicated in this list of keys.

F.5.25 SR Document Directory Record Definition

The Directory Record is based on the specification of Section F.3. It is identified by a Directory Record Type of Value "SR DOCUMENT". Table F.5-25 lists the set of keys with their associated Types for such a Directory Record Type. The description of these keys may be found in the Modules related to the Observation IE of Structured Report IOD. This Directory Record shall be used to reference an SR Document. This type of Directory Record may reference a Lower-Level Directory Entity which includes one or more Directory Records as defined in Table F.4-2.

**Table F.5-25
SR DOCUMENT KEYS**

Key	Tag	Type	Type
Specific Character Set	(0008,0005)	1C	Required if an extended or replacement character set is used in one of the keys.
Instance Number	(0020,0013)	1	
Completion Flag	(0040,A491)	1	
Verification Flag	(0040,A493)	1	
Content Date	(0008,0023)	1	
Content Time	(0008,0033)	1	
Verification DateTime	(0040,A030)	1C	Most recent Date and Time of verification among those defined in the Verifying Observer Sequence (0040,A073). Required if Verification Flag (0040,A493) is VERIFIED.
Concept Name Code Sequence	(0040,A043)	1	Code describing the concept represented by the root Content Item (Document Title). This sequence shall contain exactly one Item.
Content Sequence	(0040,A730)	1C	Contains the Target Content Items that modify the Concept Name Code Sequence of the root Content Item (Document Title). Required if the root Content Item is

			the Source Content Item of HAS CONCEPT MOD relationships.
Any Attribute of the Document IE Modules		3	

Note: Because (0004,1511) Referenced SOP Instance UID in File may be used as a "pseudo" Directory Record Key (See Table F.3-3), it is not duplicated in this list of keys.

F.5.26 Key Object Document Directory Record Definition

The Directory Record is based on the specification of Section F.3. It is identified by a Directory Record Type of Value "KEY OBJECT DOC". Table F.5-25 lists the set of keys with their associated Types for such a Directory Record Type. The description of these keys may be found in the Modules related to the Document IE of the Key Object Selection IOD. This Directory Record shall be used to reference a Key Object Selection Document. This type of Directory Record may reference a Lower-Level Directory Entity which includes one or more Directory Records as defined in Table F.4-1.

Table F.5-26
KEY OBJECT DOCUMENT KEYS

Key	Tag	Type	Type
Specific Character Set	(0008,0005)	1C	Required if an extended or replacement character set is used in one of the keys.
Instance Number	(0020,0013)	1	
Content Date	(0008,0023)	1	
Content Time	(0008,0033)	1	
Concept Name Code Sequence	(0040,A043)	1	Code describing the concept represented by the root Content Item (Document Title). This sequence shall contain exactly one Item.
Content Sequence	(0040,A730)	1C	Contains the Target Content Items that modify the Concept Name Code Sequence of the root Content Item (Document Title). Required if the root Content Item is the Source Content Item of HAS CONCEPT MOD relationships.
Any Attribute of the Document IE Modules		3	

Note: Because (0004,1511) Referenced SOP Instance UID in File may be used as a "pseudo" Directory Record Key (See Table F.3-3), it is not duplicated in this list of keys.

F.6 SPECIAL DIRECTORY RECORDS

F.6.1 Private directory record definition

Private Directory Records may also be used in addition to Standard defined Directory Records. Such Private Records shall follow the specification of Sections F.2 and F.3. In addition, if created by File-set Creators they shall be proper extensions to the DICOM Basic Directory IOD Information Model specified in Section F.4. By proper extensions it is meant that any File-set Creator creating private Directory Records shall still meet the DICOM PS 3.10 conformance requirements. Thus a File-set Reader or File-set Updater which chooses to ignore such privately defined Directory Records will find a conformant Directory.

F.6.2 Multi-referenced file directory record definition

This Directory Record is based on the specification of Section F.3. The Multi-Referenced File Directory Record (MRDR) is a special type of Directory Record which allows indirect reference to a File by multiple Directory Records. Such a Directory Record facilitates the management (deletion/update) of referenced Files by keeping an explicit count of the number of references. Instead of directly referencing a File by its Referenced File ID, a Directory Record of any of the Types define above (except the Multi-Referenced File Directory Record itself) may reference the Multi-Referenced File Directory Record which in turn will reference the File by its File ID. This Type of Directory Record shall not reference a Lower-Level Directory Entity.

The following restrictions apply to this Directory Record:

- a. Offset of the Next Directory Record shall be set to 00000000H
- b. Offset of Referenced Lower-Level Directory Entity shall be set to 00000000H
- c. Directory Record Type shall be set to MRDR
- d. Referenced File ID shall be set to the File ID of the Multi-Referenced File
- e. Referenced SOP Class UID shall be absent
- f. Referenced SOP Instance UID shall be absent

One additional attribute is defined in Table 5.5-19 and shall be included as a "pseudo" Key.

Table F.6-1
MULTI-REFERENCED FILE KEYS

Key	Tag	Type	Attribute Description
Number of References	(0004,1600)	1	<p>Number of References made by other Directory Records to this MDRD Directory Record.</p> <p>When set to 0000H the MRDR record is inactive. The Referenced File ID (0004,1510) value of the MRDR record shall be considered as invalid and ignored.</p> <p>Number of References (0004,1600) shall be reduced by one when a Directory Record of any Type (referencing this Multi-Referenced File Directory Record) is either deleted or when its Record In Use Flag (0004,1410) set to inactive. When a Directory Record of any Type (referencing this Multi-Referenced File Directory Record) is added, the Number of References (0004,1600) shall be increased by one.</p> <p>Note: If the Number of References becomes zero, it is an implementation decision whether the MRDR Directory Record is deleted or left inactive and if the Multi-Referenced File is deleted.</p>

F.7 ICON IMAGE KEY DEFINITION

An Icon Image may be used as a key representative of an Image, RT Dose, Stored Print, Series or Overlay in a corresponding Directory Record to allow an application to display icons which enable a user to select one or more from amongst several of them. It is based on the general purpose Image Pixel Module (See Annex C).

The Icon Image Key corresponds to Data Element (0088,0200). It is defined as a Sequence which contains a single Item encapsulating the Data Set made of the Data Elements of the Icon Image. The Data Elements are defined by the Image Pixel Module (see Section C.7.6.3).

The Image Pixel Module usage is restricted in a few areas to facilitate general use in Directory Record across various modality environments. These restrictions are:

- a. Only monochrome and palette color images shall be used. Samples per Pixel (0028,0002) shall have a Value of 1, Photometric Interpretation (0028,0004) shall have a Value of either MONOCHROME 1, MONOCHROME 2 or PALETTE COLOR, Planar Configuration (0028,0006) shall not be present
Note: True color icon images are not supported. This is due to the fact that the reduced size of the Icon Image makes the quality of a palette color image (with 256 colors) sufficient in most cases. This simplifies the handling of Icon Images by File-set Readers and File-set Updaters.
- b. If an FSR/FSU supports Icons (i.e. does not ignore them) then it shall support at least a maximum size of 64 by 64 Icons. An FSC may write Icons of any size. Icons larger than 64 by 64 may be ignored by FSRs and FSUs unless specialized by Application Profiles
- c. Pixel samples have a Value of either 1 or 8 for Bits Allocated (0028,0100) and Bits Stored (0028,0101). High Bit (0028,0102) shall have a Value of one less than the Value used in Bit Stored
- d. Pixel Representation (0028,0103) shall used an unsigned integer representation (Value 0000H)
- e. Pixel Aspect Ratio (0028,0034) shall have a Value of 1:1
- f. If a Palette Color lookup Table is used, an 8 Bit Allocated (0028,0100) shall be used

Annex G Integration of Modality Worklist and Modality Performed Procedure Step in the Original DICOM Standard (Informative)

DICOM was published in 1993 and effectively addresses image communication for a number of modalities and Image Management functions for a significant part of the field of medical imaging. Since then, many additional medical imaging specialties have contributed to the extension of the DICOM Standard and developed additional Image Object Definitions. Furthermore, there have been discussions about the harmonization of the DICOM Real-World domain model with other standardization bodies. This effort has resulted in a number of extensions to the DICOM Standard. The integration of the Modality Worklist and Modality Performed Procedure Step address an important part of the domain area that was not included initially in the DICOM Standard. At the same time, the Modality Worklist and Modality Performed Procedure Step integration make steps in the direction of harmonization with other standardization bodies (CEN TC 251, HL7, etc.).

The purpose of this ANNEX is to show how the original DICOM Standard relates to the extension for Modality Worklist Management and Modality Performed Procedure Step. The two included figures outline the void filled by the Modality Worklist Management and Modality Performed Procedure Step specification, and the relationship between the original DICOM Data Model and the extended model.

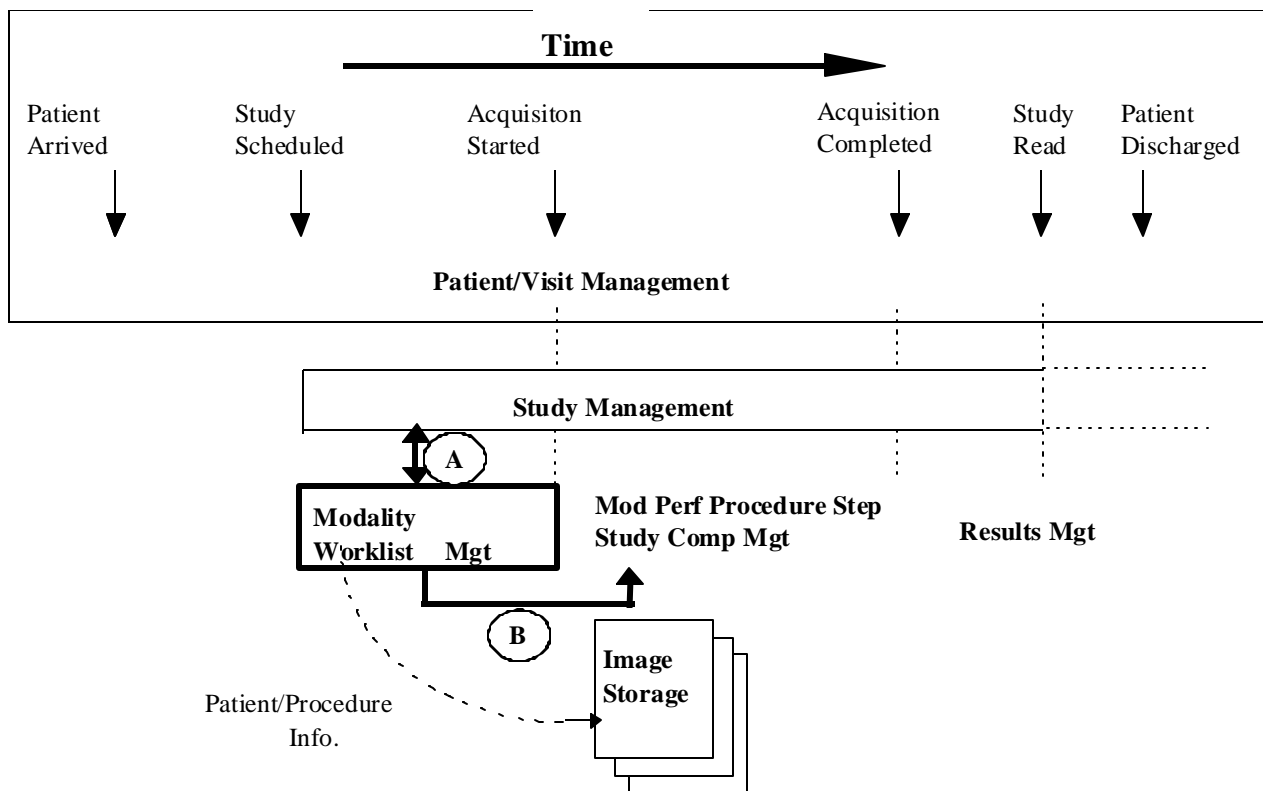

Figure G-1: Functional View - Modality Worklist and Modality Performed Procedure Step Management in the Context of DICOM Service Classes

The management of a patient starts when the patient enters a physical facility (e.g. a hospital, a clinic, an imaging center) or even before that time. The DICOM Patient Management SOP Class provides many of the functions that are of interest to imaging departments. Figure G1 is an example where one presumes that an order for a procedure has been issued for a patient. The order for an imaging procedure results in the creation of a Study Instance within the DICOM Study Management SOP Class. At the same time (A) the Modality Worklist Management SOP Class enables a modality operator to request the scheduling information for the ordered procedures. A worklist can be constructed based on the scheduling information. The handling of the requested imaging procedure in DICOM Study Management and in DICOM Worklist Management are closely related. The worklist also conveys patient/study demographic information that can be incorporated into the images.

Worklist Management is completed once the imaging procedure has started and the Scheduled Procedure Step has been removed from the Worklist, possibly in response to the Modality Performed Procedure Step (B). However, Study Management continues throughout all stages of the Study, including interpretation. The actual procedure performed (based on the request) and information about the images produced are conveyed by the DICOM Study Component SOP Class or the Modality Performed Procedure Step SOP Classes.

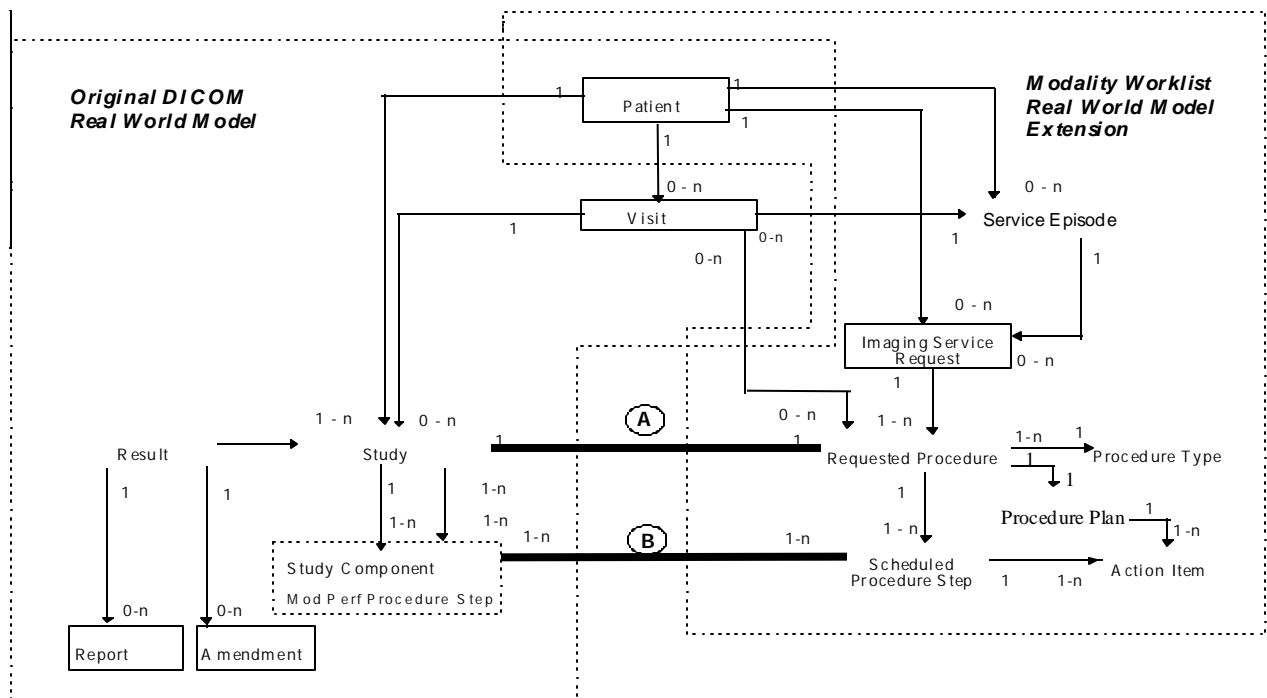

Figure G-2: Relationship of the Original Model and the Extensions for Modality Worklist and Modality Performed Procedure Step Management

Figure G-2 shows the relationship between the original DICOM Real-World model and the extensions of this Real-World model required to support the Modality Worklist and the Modality Performed Procedure Step. The new parts of the model add entities that are needed to request, schedule, and describe the performance of imaging procedures, concepts that were not supported in the original model. The entities required for representing the Worklist form a natural extension of the original DICOM Real-World model.

Common to both the original model and the extended model is the Patient entity. The Service Episode is an administrative concept that has been shown in the extended model in order to pave the way for future adaptation to a common model supported by other standardization groups including HL7, CEN TC 251 WG 3, CAP-IEC, etc. The Visit is in the original model but not shown in the extended model because it is a part of the Service Episode.

There is a 1 to 1 relationship between a Requested Procedure and the DICOM Study (A). A DICOM Study is the result of a single Requested Procedure. A Requested Procedure can result in only one Study.

A n:m relationship exists between a Scheduled Procedure Step and a Modality Performed Procedure Step (B). The concept of a Modality Performed Procedure Step is a superset of the Study Component concept contained in the original DICOM model. The Modality Performed Procedure Step SOP Classes provide a means to relate Modality Performed Procedure Steps to Scheduled Procedure Steps.

Annex H Retired

Annex I Retired

Annex J - Waveforms (Informative)

J.1 DOMAIN OF APPLICATION

Waveform acquisition is part of both the medical imaging environment and the general clinical environment. Because of its broad use, there has been significant previous and complementary work in waveform standardization of which the following are particularly important:

ASTM E31.16 - E1467 Specification for Transferring Digital Neurophysiological Data Between Independent Computer Systems

CEN TC251 PT5-007 - prENV1064 draft Standard Communications Protocol for Computer-Assisted Electrocardiography (SCP-ECG).

CEN TC251 PT5-021 - draft Vital Signs Information Representation Standard (VITAL)

HL7 Automated Data SIG - HL7 Version 2.3, Chapter 7.14-20

IEEE P1073 - draft Medical Information Bus Standard (MIB)

DICOM - NEMA PS3.3, Section A.10 Standalone Curve Information Object Definition

For DICOM, the domain of waveform standardization is waveform acquisition within the imaging context. It is specifically meant to address waveform acquisitions which will be analyzed with other data which is transferred and managed using the DICOM protocol. It allows the addition of waveform data to that context with minimal incremental cost. Further, it leverages the DICOM persistent object capability for maintaining referential relationships to other data collected in a multi-modality environment, including references necessary for multi-modality synchronization.

Waveform interchange in other clinical contexts may use different protocols more appropriate to those domains. In particular, HL7 may be used for transfer of waveform observations to general clinical information systems, and MIB may be used for real-time physiological monitoring and therapy.

The waveform information object definition in DICOM has been specifically harmonized at the semantic level with the HL7 waveform message format. The use of a common object model allows straightforward transcoding and interoperation between systems that use DICOM for waveform interchange and those that use HL7, and may be viewed as an example of common semantics implemented in the differing syntaxes of two messaging systems.

Note: HL7 allows transport of DICOM SOP Instances (information objects) encapsulated within HL7 messages. Since the DICOM and HL7 waveform semantics are harmonized, DICOM Waveform SOP Instances need not be transported as encapsulated data, as they can be transcoded to native HL7 Waveform Observation format.

J.2 USE CASES

The following are specific use case examples for waveforms in the imaging environment.

Case 1: Catheterization Laboratory - During a cardiac catheterization, several independent pieces of data acquisition equipment may be brought together for the exam. An electrocardiographic subsystem records surface ECG waveforms; an X-ray angiographic subsystem records motion images; a hemodynamic subsystem records intracardiac pressures from a sensor on the catheter.

These subsystems send their acquired data by network to a repository. These data are assembled at an analytic workstation by retrieving from the repository. For a left ventriculographic procedure, the ECG is used by the physician to determine the time of maximum and minimum ventricular fill, and when coordinated with the angiographic images, an accurate estimate of the ejection fraction can be calculated. For a valvuloplasty procedure, the hemodynamic waveforms are used to calculate the pre-intervention and post-intervention pressure gradients.

Case 2: Electrophysiology Laboratory - An electrophysiological exam will capture waveforms from multiple sensors on a catheter; the placement of the catheter in the heart is captured on an angiographic image. At an analytic workstation, the exact location of the sensors can thus be aligned with a model of the heart, and the relative timing of the arrival of the electrophysiological waves at different cardiac locations can be mapped.

Case 3: Stress Exam - A stress exam may involve the acquisition of both ECG waveforms and echocardiographic ultrasound images from portable equipment at different stages of the test. The waveforms and the echocardiograms are output on an interchange disk, which is then input and read at a review station. The physician analyzes both types of data to make a diagnosis of cardiac health.

J.3 TIME SYNCHRONIZATION FRAME OF REFERENCE

Synchronization of acquisition across multiple modalities in a single study (e.g., angiography and electrocardiography) requires either a shared trigger, or a shared clock. A Synchronization Module within the Frame of Reference Information Entity specifies the synchronization mechanism. A common temporal environment used by multiple equipment is identified by a shared Synchronization Frame of Reference UID. How this UID is determined and distributed to the participating equipment is outside the scope of the standard.

The method used for time synchronization of equipment clocks is implementation or site specific, and therefore outside the scope of this proposal. If required, standard time distribution protocols are available (e.g., NTP, IRIG, GPS).

*An informative description of time distribution methods can be found at:
<http://www.bancomm.com/cntpApp.htm>*

A second method of synchronizing acquisitions is to utilize a common reference channel (temporal fiducial), which is recorded in the data acquired from the several equipment units participating in a study, and/or which is used to trigger synchronized data acquisitions. For instance, the "X-ray on" pulse train which triggers the acquisition of frames for an X-ray angiographic SOP Instance can be recorded as a waveform channel in a simultaneously acquired hemodynamic waveform SOP Instance, and can be used to align the different object instances. Associated with this Supplement are proposed coded entry channel identifiers to specifically support this synchronization mechanism (DICOM Terminology Mapping Resource Context Group ID 3090).

J.4 WAVEFORM ACQUISITION MODEL

Figure J.4-1 shows a canonical model of waveform data acquisition. A patient is the subject of the study. There may be several sensors placed at different locations on or in the patient, and waveforms are measurements of some physical quality (metric) by those sensors (e.g., electrical voltage, pressure, gas concentration, or sound). The sensor is typically connected to an amplifier and filter, and its output is sampled at constant time intervals and digitized. In most cases, several signal channels are acquired synchronously. The measured signal usually originates in the anatomy of the patient, but an important special case is a signal which originates in the equipment, either as a stimulus, such as a cardiac pacing signal, as a therapy, such as a radio frequency signal used for ablation, or as a synchronization signal.

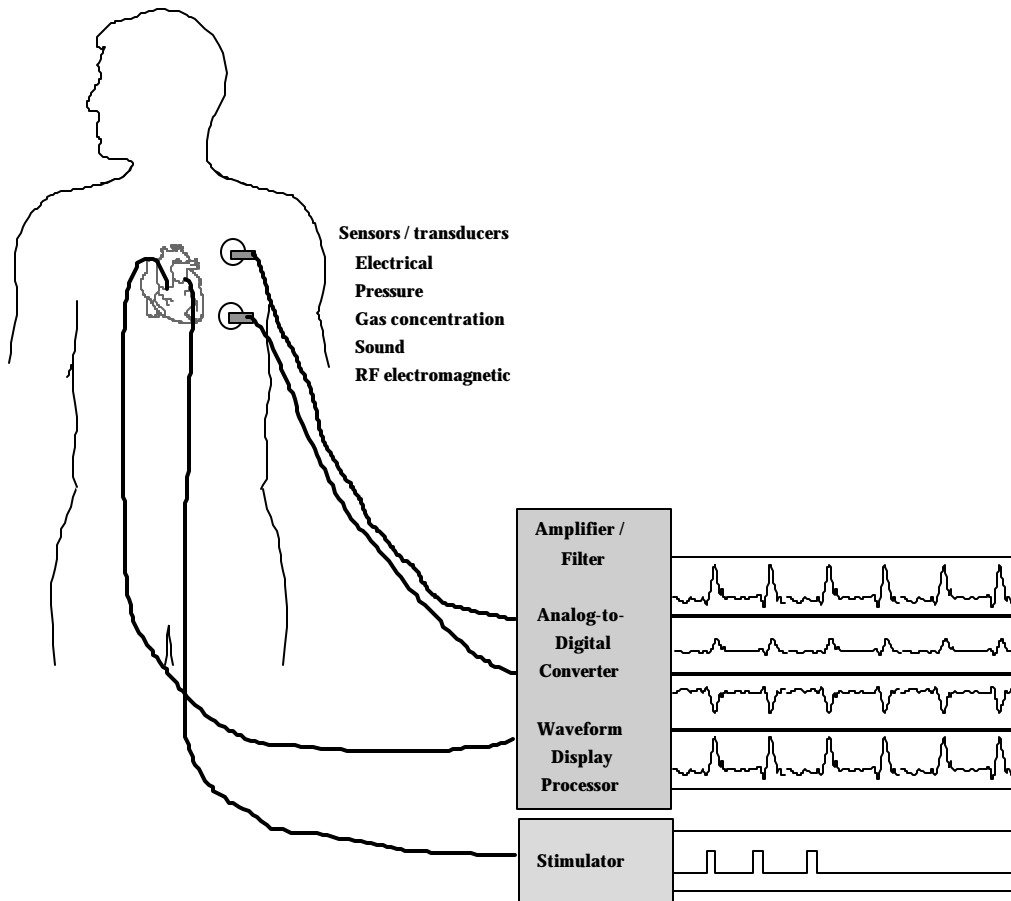

Figure J.4-1 - Waveform Acquisition Model

J.5 WAVEFORM INFORMATION MODEL

The part of the composite information object which carries the waveform data is the Waveform Information Entity (IE). The Waveform IE includes the technical parameters of waveform acquisition and the waveform samples.

The information model, or internal organizational structure, of the Waveform IE is shown in Figure J.5-1. A waveform information object includes data from a continuous time period during which signals were acquired. The object may contain several multiplex groups, each defined by digitization with the same clock whose frequency is defined for the group. Within each multiplex group there will be one or more channels, each with a full technical definition. Finally, each channel has its set of digital waveform samples.

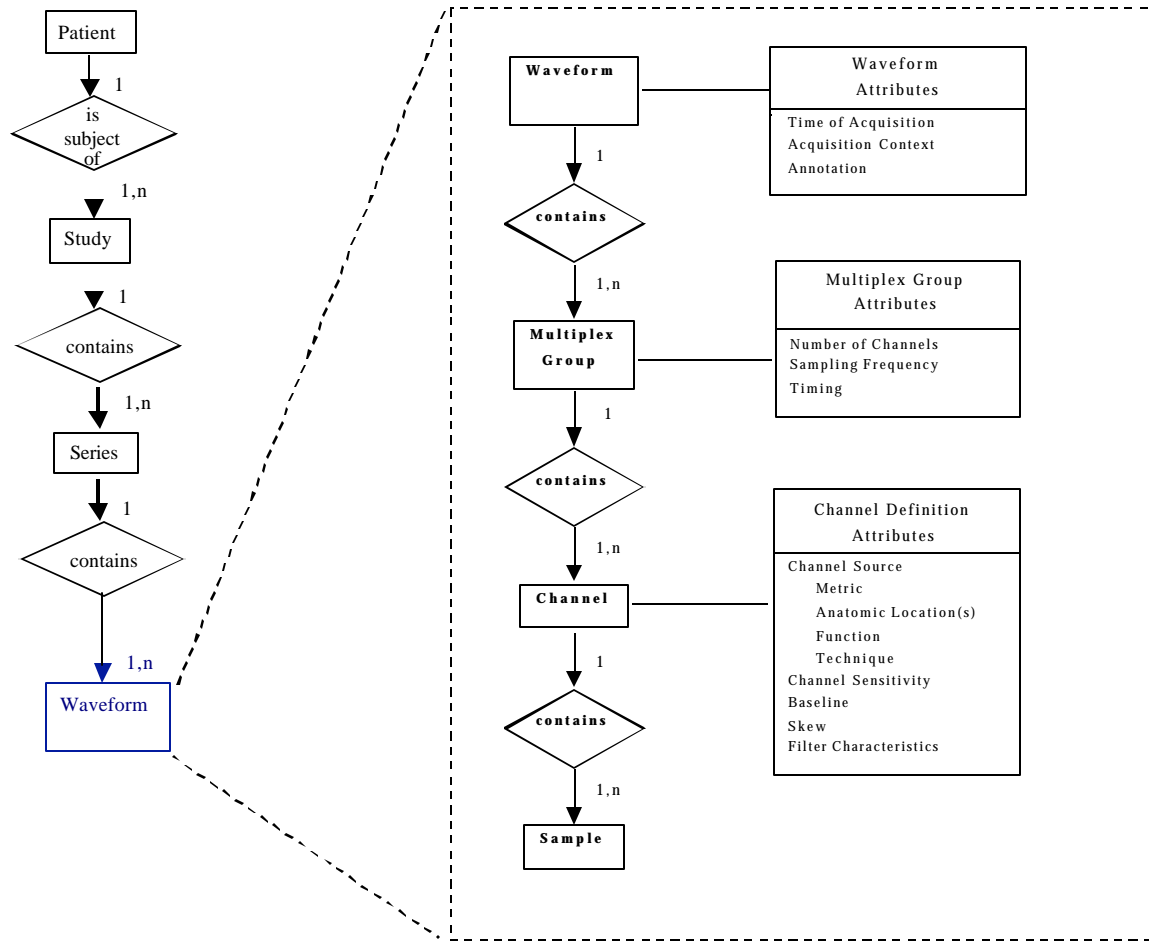

Figure J.5-1 DICOM Waveform Information Model

J.6 HARMONIZATION WITH HL7

This Waveform IE definition is harmonized with the HL7 waveform semantic constructs, including the channel definition attributes and the use of multiplex groups for synchronously acquired channels. The use of a common object model allows straightforward transcoding and interoperability between systems that use DICOM for waveform interchange and those that use HL7, and may be viewed as an example of common semantics implemented in the differing syntaxes of two messaging systems.

This section describes the congruence between the DICOM Waveform IE and the HL7 version 2.3 waveform message format (see HL7 version 2.3 Chapter 7, sections 7.14 – 7.20).

J.6.1 HL7 Waveform Observation

Waveforms in HL7 messages are sent in a set of OBX (Observation) Segments. Four subtypes of OBX segments are defined:

- The CHN subtype defines one channel in a CD (Channel Definition) Data Type
- The TIM subtype defines the start time of the waveform data in a TS (Time String) Data Type
- The WAV subtype carries the waveform data in an NA (Numeric Array) or MA (Multiplexed Array) Data Type (ASCII encoded samples, character delimited)

- The ANO subtype carries an annotation in a CE (Coded Entry) Data Type with a reference to a specific time within the waveform to which the annotation applies

Other segments of the HL7 message definition specify patient and study identification, whose harmonization with DICOM constructs is not defined in this Annex.

J.6.2 Channel Definition

The Waveform Module Channel Definition sequence attribute (003A,0200) is defined in harmonization with the HL7 Channel Definition (CD) Data Type, in accordance with the following Table. Each Item in the Channel Definition sequence attribute corresponds to an OBX Segment of subtype CHN.

**Table J.6-1
Correspondence Between DICOM and HL7 Channel Definition**

DICOM Attribute		HL7 CD Data Type Component
Waveform Channel Number	(003A,0202)	Channel Identifier (number&name)
Channel Label	(003A,0203)	
Channel Source Sequence	(003A,0208)	Waveform Source
Channel Source Modifier Sequence	(003A,0209)	
Channel Sensitivity	(003A,0210)	Channel Sensitivity and Units
Channel Sensitivity Units Sequence	(003A,0211)	
Channel Sensitivity Correction Factor	(003A,0212)	Channel Calibration Parameters (correctionfactor&baseline×kew)
Channel Baseline	(003A,0213)	
Channel Time Skew	(003A,0214)	
[Group] Sampling Frequency	(003A,001A)	Channel Sampling Frequency
Channel Minimum Value	(5400,0110)	Minimum and Maximum Data Values (minimum&maximum)
Channel Maximum Value	(5400,0112)	
Channel Offset	(003A,0218)	not defined in HL7
Channel Status	(003A,0205)	
Filter Low Frequency	(003A,0220)	
Filter High Frequency	(003A,0221)	
Notch Filter Frequency	(003A,0222)	
Notch Filter Bandwidth	(003A,0223)	

In the DICOM information object definition, the sampling frequency is defined for the multiplex group, while in HL7 it is defined for each channel, but is required to be identical for all multiplexed channels.

Note that in the HL7 syntax, Waveform Source is a string, rather than a coded entry as used in DICOM. This should be considered in any transcoding between the two formats.

J.6.3 Timing

In HL7, the exact start time for waveform data is sent in an OBX Segment of subtype TIM. The corresponding DICOM attributes, which must be combined to form the equivalent time string, are:

Acquisition Datetime	(0008,002A)
Multiplex Group Time Offset	(0018,1068)

J.6.4 Waveform Data

The DICOM binary encoding of data samples in the Waveform Data attribute (5400,1010) corresponds to the ASCII representation of data samples in the HL7 OBX Segment of subtype WAV. The same channel-interleaved multiplexing used in the HL7 MA (Multiplexed Array) Data Type is used in the DICOM Waveform Data attribute.

Because of its binary representation, DICOM uses several data elements to specify the precise encoding, as listed in the following Table. There are no corresponding HL7 data elements, since HL7 uses explicit character-delimited ASCII encoding of data samples.

Number of Waveform Channels	(003A,0005)
Number of Waveform Samples	(003A,0010)
Waveform Bits Stored	(003A,021A)
Waveform Bits Allocated	(5400,1004)
Waveform Sample Interpretation	(5400,1006)
Waveform Padding Value	(5400,100A)

J.6.5 Annotation

In HL7, Waveform Annotation is sent in an OBX Segment of subtype ANO, using the CE (Coded Entry) Data Type CE. This corresponds precisely to the DICOM Annotation using Coded Entry Sequences. However, HL7 annotation ROI is to a single point only (time reference), while DICOM allows reference to ranges of samples delimited by time or by explicit sample position.

J.7 HARMONIZATION WITH SCP-ECG

The SCP-ECG standard is designed for recording routine resting electrocardiograms. Such ECGs are reviewed prior to cardiac imaging procedures, and a typical use case would be for SCP-ECG waveforms to be translated to DICOM for inclusion with the full cardiac imaging patient record.

SCP-ECG provides for either simultaneous or non-simultaneous recording of the channels, but does not provide a multiplexed data format (each channel is separately encoded). When translating to DICOM, each subset of simultaneously recorded channels may be encoded in a Waveform Sequence Item (multiplex group), and the delay to the recording of each multiplex group shall be encoded in the Multiplex Group Time Offset (0018,1068).

The electrode configuration of SCP-ECG Section 1 may be translated to the DICOM Acquisition Context (0040,0555) sequence items using DICOM Terminology Mapping Resource Template 3401 and Context Groups 3263 and 3264.

The lead identification of SCP-ECG Section 3, a term coded as an unsigned integer, may be translated to the DICOM Waveform Channel Source (003A,0208) coded sequence using Context Group 3001.

Pacemaker spike records of SCP-ECG Section 7 may be translated to items in the Waveform Annotations Sequence (0040,B020) with a code term from Context Group 3335. The annotation sequence item may record the spike amplitude in its Numeric Value and Measurement Units attributes.

Annex K (informative)

The following is a simple and non-comprehensive illustration of the encoding of the Informative SR Content Tree Example of Figure C.17.4-1.

SR Tree Depth	Nesting	Attribute	Tag	VR	VL (hex)	Value
		SOP Class UID	(0008,0016)	UI	001e	1.2.840.10008.5.1.4.1.1.88.33
		SOP Instance UID	(0008,0018)	UI	0012	1.2.3.4.5.6.7.300
		Study Date	(0008,0020)	DA	0008	19991029
		Content Date	(0008,0023)	DA	0008	19991029
		Study Time	(0008,0030)	TM	0006	154500
		Content Time	(0008,0033)	TM	0006	154510
		Accession Number	(0008,0050)	SH	0006	123456
		Modality	(0008,0060)	CS	0002	SR
		Manufacturer	(0008,0070)	LO	0004	WG6
		Referring Physician's Name	(0008,0090)	PN	0014	Luke^Will^Dr.^M.D.
		Referenced Study Component Sequence	(0008,1111)	SQ	fffffff	
	%endseq					
		Patient's Name	(0010,0010)	PN	000e	Homer^Jane^^
		Patient's ID	(0010,0020)	LO	0006	234567
		Patient's Birth Date	(0010,0030)	DA	0008	19991109
		Patient's Sex	(0010,0040)	CS	0002	F
		Study Instance UID	(0020,000D)	UI	0012	1.2.3.4.5.6.7.100
		Series Instance UID	(0020,000E)	UI	0012	1.2.3.4.5.6.7.200
		Study ID	(0020,0010)	SH	0006	345678
		Series Number	(0020,0011)	IS	0002	1
		Instance (formerly Image) Number	(0020,0013)	IS	0002	1
1		Value Type	(0040,a040)	CS	000a	CONTAINER
1		Concept Name Code Sequence	(0040,a043)	SQ	fffffff	
1	%item					
1	>	Code Value	(0008,0100)	SH	0006	333300
1	>	Coding Scheme Designator	(0008,0102)	SH	0006	LNdemo
1	>	Code Meaning	(0008,0104)	LO	000c	Chest X-Ray
1	%enditem					
	%endseq					
1		Continuity Of Content	(0040,a050)	CS	0008	SEPARATE
		Verifying Observer Sequence	(0040,a073)	SQ	fffffff	

	%item					
>	Verifying Organization	(0040,a027)	LO	0004	WG6	
>	Verification DateTime	(0040,a030)	DT	000e	19991029154510	
>	Verifying Observer Name	(0040,a075)	PN	000e	Jones^Joe^Dr^	
>	Verifying Observer Identification Code Sequence	(0040,a088)	SQ	fffffff		
	%item					
>>	Code Value	(0008,0100)	SH	0006	369842	
>>	Coding Scheme Designator	(0008,0102)	SH	000e	99STEIsewhere	
>>	Code Meaning	(0008,0104)	LO	0006	369842	
>>	Private Coding Scheme Creator UID	(0008,010c)	UI	0010	1.2.3.4.6.7.8.91	
	%enditem					
	%endseq					
	%enditem					
	%endseq					
	Referenced Request Sequence	(0040,a370)	SQ	fffffff		
	%item					
>	Accession Number	(0008,0050)	SH	0006	123456	
>	Referenced Study Sequence	(0008,1110)	SQ	fffffff		
	%endseq					
>	Study Instance UID	(0020,000D)	UI	0012	1.2.3.4.5.6.7.100	
>	Requested Procedure Description	(0032,1060)	LO	000a	Chest Xray	
>	Requested Procedure Code Sequence	(0032,1064)	SQ	fffffff		
	%item					
>>	Code Value	(0008,0100)	SH	0006	369475	
>>	Coding Scheme Designator	(0008,0102)	SH	000e	99STEIsewhere	
>>	Code Meaning	(0008,0104)	LO	000a	Chest XRay	
>>	Private Coding Scheme Creator UID	(0008,010c)	UI	0010	1.2.3.4.6.7.8.91	
	%enditem					
	%endseq					
>	Requested Procedure ID	(0040,1001)	SH	0006	012340	
>	Placer Order Number/Imaging Service Request	(0040,2016)	LO	0		
>	Filler Order Number/Imaging Service Request	(0040,2017)	LO	0		
	%enditem					
	%endseq					
	Performed Procedure Code Sequence	(0040,a372)	SQ	fffffff		
	%item					
>	Code Value	(0008,0100)	SH	0006	369475	
>	Coding Scheme Designator	(0008,0102)	SH	000e	99STEIsewhere	
>	Code Meaning	(0008,0104)	LO	000a	Chest XRay	

	>	Private Coding Scheme Creator UID	(0008,010c)	UI	0010	1.2.3.4.6.7.8.91
	%enditem					
	%endseq					
		Current Requested Procedure Evidence Sequence	(0040,a375)	SQ	fffffff	
	%item					
	>	Referenced Series Sequence	(0008,1115)	SQ	fffffff	
	%item					
	>>	Referenced SOP Sequence	(0008,1199)	SQ	fffffff	
	%item					
	>>>	Referenced SOP Class UID	(0008,1150)	UI	0008	1.2.3.4
	>>>	Referenced SOP Instance UID	(0008,1155)	UI	000a	1.2.3.4.5
	%enditem					
	%endseq					
	>>	Series Instance UID	(0020,000E)	UI	0012	1.2.3.4.5.6.7.200
	%enditem					
	%endseq					
	>	Study Instance UID	(0020,000D)	UI	0012	1.2.3.4.5.6.7.100
	%enditem					
	%endseq					
		Completion Flag	(0040,a491)	CS	0008	COMPLETE
		Verification Flag	(0040,a493)	CS	0008	VERIFIED
1		Content Sequence	(0040,a730)	SQ	fffffff	
1.1	%item					
1.1	>	Relationship Type	(0040,a010)	CS	0010	HAS OBS CONTEXT
1.1	>	Value Type	(0040,a040)	CS	0006	PNAME
1.1	>	Concept Name Code Sequence	(0040,a043)	SQ	fffffff	
1.1	%item					
1.1	>>	Code Value	(0008,0100)	SH	0006	000555
1.1	>>	Coding Scheme Designator	(0008,0102)	SH	0006	LNdemo
1.1	>>	Code Meaning	(0008,0104)	LO	0012	Recording Observer
1.1	%enditem					
1.1	%endseq					
1.1	>	Person Name	(0040,a123)	PN	0010	Smith^John^Dr^
1.1	%enditem					
1.2	%item					
1.2	>	Relationship Type	(0040,a010)	CS	0010	HAS OBS CONTEXT
1.2	>	Value Type	(0040,a040)	CS	0006	UIDREF
1.2	>	Concept Name Code Sequence	(0040,a043)	SQ	fffffff	
1.2	%item					
1.2	>>	Code Value	(0008,0100)	SH	0006	000599

1.2	>>	Coding Scheme Designator	(0008,0102)	SH	0006	LNdemo
1.2	>>	Code Meaning	(0008,0104)	LO	0036	Study Instance UID of Evidence Directly Examined by RO
1.2	%enditem					
1.2	%endseq					
1.2	>	UID	(0040,a124)	UI	0012	1.2.3.4.5.6.7.100
1.2	%enditem					
1.3	%item					
1.3	>	Relationship Type	(0040,a010)	CS	0010	HAS OBS CONTEXT
1.3	>	Value Type	(0040,a040)	CS	0006	PNAME
1.3	>	Concept Name Code Sequence	(0040,a043)	SQ	ffffffff	
1.3	%item					
1.3	>>	Code Value	(0008,0100)	SH	0006	000579
1.3	>>	Coding Scheme Designator	(0008,0102)	SH	0006	LNdemo
1.3	>>	Code Meaning	(0008,0104)	LO	0020	Patient-Data-Acquisition Subject
1.3	%enditem					
1.3	%endseq					
1.3	>	Person Name	(0040,a123)	PN	000e	Homer^Jane^^
1.3	%enditem					
1.4	%item					
1.4	>	Relationship Type	(0040,a010)	CS	0008	CONTAINS
1.4	>	Value Type	(0040,a040)	CS	0004	CODE
1.4	>	Concept Name Code Sequence	(0040,a043)	SQ	ffffffff	
1.4	%item					
1.4	>>	Code Value	(0008,0100)	SH	0006	000444
1.4	>>	Coding Scheme Designator	(0008,0102)	SH	0006	LNdemo
1.4	>>	Code Meaning	(0008,0104)	LO	0008	Finding
1.4	%enditem					
1.4	%endseq					
1.4	>	Concept Code Sequence	(0040,a168)	SQ	ffffffff	
1.4	%item					
1.4	>>	Code Value	(0008,0100)	SH	0006	000333
1.4	>>	Coding Scheme Designator	(0008,0102)	SH	000e	99STEIelsewhere
1.4	>>	Code Meaning	(0008,0104)	LO	0004	Mass
1.4	>>	Private Coding Scheme Creator UID	(0008,010c)	UI	0010	1.2.3.4.6.7.8.91
1.4	%enditem					
1.4	%endseq					
1.4	>	Content Sequence	(0040,a730)	SQ	ffffffff	
1.4.1	%item					
1.4.1	>>	Relationship Type	(0040,a010)	CS	000e	HAS PROPERTIES

1.4.1	>>	Value Type	(0040,a040)	CS	0004	NUM
1.4.1	>>	Concept Name Code Sequence	(0040,a043)	SQ	fffffff	
1.4.1	%item					
1.4.1	>>>	Code Value	(0008,0100)	SH	0006	000222
1.4.1	>>>	Coding Scheme Designator	(0008,0102)	SH	0006	LNdemo
1.4.1	>>>	Code Meaning	(0008,0104)	LO	0008	Diameter
1.4.1	%enditem					
1.4.1	%endseq					
1.4.1	>>	Measured Value Sequence	(0040,a300)	SQ	fffffff	
1.4.1	%item					
1.4.1	>>>	Measurement Units Code Sequence	(0040,08ea)	SQ	fffffff	
1.4.1	%item					
1.4.1	>>>>	Code Value	(0008,0100)	SH	0006	000111
1.4.1	>>>>	Coding Scheme Designator	(0008,0102)	SH	0008	SNMdemo
1.4.1	>>>>	Code Meaning	(0008,0104)	LO	0002	cm
1.4.1	%enditem					
1.4.1	%endseq					
1.4.1	>>>	Numeric Value	(0040,a30a)	DS	0004	1.3
1.4.1	%enditem					
1.4.1	%endseq					
1.4.1	%enditem					
1.4.2	%item					
1.4.2	>>	Relationship Type	(0040,a010)	CS	000e	HAS PROPERTIES
1.4.2	>>	Value Type	(0040,a040)	CS	0004	CODE
1.4.2	>>	Concept Name Code Sequence	(0040,a043)	SQ	fffffff	
1.4.2	%item					
1.4.2	>>>	Code Value	(0008,0100)	SH	0006	111000
1.4.2	>>>	Coding Scheme Designator	(0008,0102)	SH	0008	SNMdemo
1.4.2	>>>	Code Meaning	(0008,0104)	LO	000c	Margination
1.4.2	%enditem					
1.4.2	%endseq					
1.4.2	>>	Concept Code Sequence	(0040,a168)	SQ	fffffff	
1.4.2	%item					
1.4.2	>>>	Code Value	(0008,0100)	SH	0006	222000
1.4.2	>>>	Coding Scheme Designator	(0008,0102)	SH	0008	SNMdemo
1.4.2	>>>	Code Meaning	(0008,0104)	LO	000c	Infiltrative
1.4.2	%enditem					
1.4.2	%endseq					
1.4.2	%enditem					
1.4	%endseq					
1.4	%enditem					

1.5	%item					
1.5	>	Referenced SOP Sequence	(0008,1199)	SQ	fffffff	
1.5	%item					
1.5	>>	Referenced SOP Class UID	(0008,1150)	UI	0008	1.2.3.4
1.5	>>	Referenced SOP Instance UID	(0008,1155)	UI	000a	1.2.3.4.5
1.5	%enditem					
1.5	%endseq					
1.5	>	Relationship Type	(0040,a010)	CS	0008	CONTAINS
1.5	>	Value Type	(0040,a040)	CS	0006	IMAGE
1.5	>	Concept Name Code Sequence	(0040,a043)	SQ	fffffff	
1.5	%item					
1.5	>>	Code Value	(0008,0100)	SH	0006	333000
1.5	>>	Coding Scheme Designator	(0008,0102)	SH	0008	SNMdemo
1.5	>>	Code Meaning	(0008,0104)	LO	0008	Baseline
1.5	%enditem					
1.5	%endseq					
1.5	%enditem					
1.6	%item					
1.6	>	Relationship Type	(0040,a010)	CS	0008	CONTAINS
1.6	>	Value Type	(0040,a040)	CS	000a	CONTAINER
1.6	>	Concept Name Code Sequence	(0040,a043)	SQ	fffffff	
1.6	%item					
1.6	>>	Code Value	(0008,0100)	SH	0006	555000
1.6	>>	Coding Scheme Designator	(0008,0102)	SH	0006	LNdemo
1.6	>>	Code Meaning	(0008,0104)	LO	000c	Conclusions
1.6	%enditem					
1.6	%endseq					
1.6		Continuity Of Content	(0040,a050)	CS	0008	SEPARATE
1.6	>	Content Sequence	(0040,a730)	SQ	fffffff	
1.6.1	%item					
1.6.1	>>	Relationship Type	(0040,a010)	CS	0008	CONTAINS
1.6.1	>>	Value Type	(0040,a040)	CS	0004	CODE
1.6.1	>>	Concept Name Code Sequence	(0040,a043)	SQ	fffffff	
1.6.1	%item					
1.6.1	>>>	Code Value	(0008,0100)	SH	0006	777000
1.6.1	>>>	Coding Scheme Designator	(0008,0102)	SH	0006	LNdemo
1.6.1	>>>	Code Meaning	(0008,0104)	LO	000a	Conclusion
1.6.1	%enditem					
1.6.1	%endseq					
1.6.1	>>	Concept Code Sequence	(0040,a168)	SQ	fffffff	
1.6.1	%item					

1.6.1	>>>	Code Value	(0008,0100)	SH	0006	888000
1.6.1	>>>	Coding Scheme Designator	(0008,0102)	SH	000e	99STEIelsewhere
1.6.1	>>>	Code Meaning	(0008,0104)	LO	0014	Probable malignancy
1.6.1	>>	Private Coding Scheme Creator UID	(0008,010c)	UI	0010	1.2.3.4.6.7.8.91
1.6.1	%enditem					
1.6.1	%endseq					
1.6.1	>>	Content Sequence	(0040,a730)	SQ	ffffff	
1.6.1.1	%item					
1.6.1.1	>>>	Relationship Type	(0040,a010)	CS	000e	INFERRED FROM
1.6.1.1	>>>	Referenced Content Item Identifier	(0040,db73)	UL	000c	0001,0004,0002
1.6.1.1	%enditem					
1.6.1.2	%item					
1.6.1.2	>>>	Relationship Type	(0040,a010)	CS	000e	INFERRED FROM
1.6.1.2	>>>	Referenced Content Item Identifier	(0040,db73)	UL	000c	0001,0007,0001
1.6.1.2	%enditem					
1.6.1	%endseq					
1.6.1	%enditem					
1.6	%endseq					
1.6	%enditem					
1.7	%item					
1.7	>	Relationship Type	(0040,a010)	CS	0008	CONTAINS
1.7	>	Value Type	(0040,a040)	CS	000a	CONTAINER
1.7	>	Concept Name Code Sequence	(0040,a043)	SQ	ffffff	
1.7	%item					
1.7	>>	Code Value	(0008,0100)	SH	0006	999000
1.7	>>	Coding Scheme Designator	(0008,0102)	SH	0006	LNdemo
1.7	>>	Code Meaning	(0008,0104)	LO	0018	Specific Image Findings
1.7	%enditem					
1.7	%endseq					
1.7		Continuity Of Content	(0040,a050)	CS	0008	SEPARATE
1.7	>	Content Sequence	(0040,a730)	SQ	ffffff	
1.7.1	%item					
1.7.1	>>	Relationship Type	(0040,a010)	CS	0008	CONTAINS
1.7.1	>>	Value Type	(0040,a040)	CS	0006	SCOORD
1.7.1	>>	Concept Name Code Sequence	(0040,a043)	SQ	ffffff	
1.7.1	%item					
1.7.1	>>>	Code Value	(0008,0100)	SH	0006	333001
1.7.1	>>>	Coding Scheme Designator	(0008,0102)	SH	0008	SNMdemo
1.7.1	>>>	Code Meaning	(0008,0104)	LO	001e	Best illustration of findings

1.7.1	%enditem					
1.7.1	%endseq					
1.7.1	>>	Content Sequence	(0040,a730)	SQ	fffffff	
1.7.1.1	%item					
1.7.1.1	>>>	Referenced SOP Sequence	(0008,1199)	SQ	fffffff	
1.7.1.1	%item					
1.7.1.1	>>>>	Referenced SOP Class UID	(0008,1150)	UI	0008	1.2.3.4
1.7.1.1	>>>>	Referenced SOP Instance UID	(0008,1155)	UI	000a	1.2.3.4.6
1.7.1.1	%enditem					
1.7.1.1	%endseq					
1.7.1.1	>>>	Relationship Type	(0040,a010)	CS	000e	SELECTED FROM
1.7.1.1	>>>	Value Type	(0040,a040)	CS	0006	IMAGE
1.7.1.1	%enditem					
1.7.1	%endseq					
1.7.1	>>	Graphic Data	(0070,0022)	FL	0020	0,0,0,0,0,0,0
1.7.1	>>	Graphic Type	(0070,0023)	CS	0008	POLYLINE
1.7.1	%enditem					
1.7	%endseq					
1.7	%enditem					
1.8	%item					
1.8	>	Relationship Type	(0040,a010)	CS	0010	HAS CONCEPT MOD
1.8	>	Value Type	(0040,a040)	CS	0004	CODE
1.8	>	Concept Name Code Sequence	(0040,a043)	SQ	fffffff	
1.8	%item					
1.8	>>	Code Value	(0008,0100)	SH	0006	123456
1.8	>>	Coding Scheme Designator	(0008,0102)	SH	0006	LNdemo
1.8	>>	Code Meaning	(0008,0104)	LO	0006	Views
1.8	%enditem					
1.8	%endseq					
1.8	>	Concept Code Sequence	(0040,a168)	SQ	fffffff	
1.8	%item					
1.8	>>	Code Value	(0008,0100)	SH	0006	123457
1.8	>>	Coding Scheme Designator	(0008,0102)	SH	0006	LNdemo
1.8	>>	Code Meaning	(0008,0104)	LO	000e	PA and Lateral
1.8	%enditem					
1.8	%endseq					
1.8	%enditem					
1	%endseq					

Annex L Mammography CAD (Informative)

L.1 Mammography CAD SR Content Tree Structure

The templates for the Mammography CAD SR IOD are defined in PS 3.16, Annex A, DCMR Templates. Relationships defined in the Mammography CAD SR IOD templates are by-value, unless otherwise stated. Content items referenced from another SR object instance, such as a prior Mammography CAD SR, are inserted by-value in the new SR object instance, with appropriate original source observation context. It is necessary to update Rendering Intent, and referenced content item identifiers for by-reference relationships, within content items paraphrased from another source.

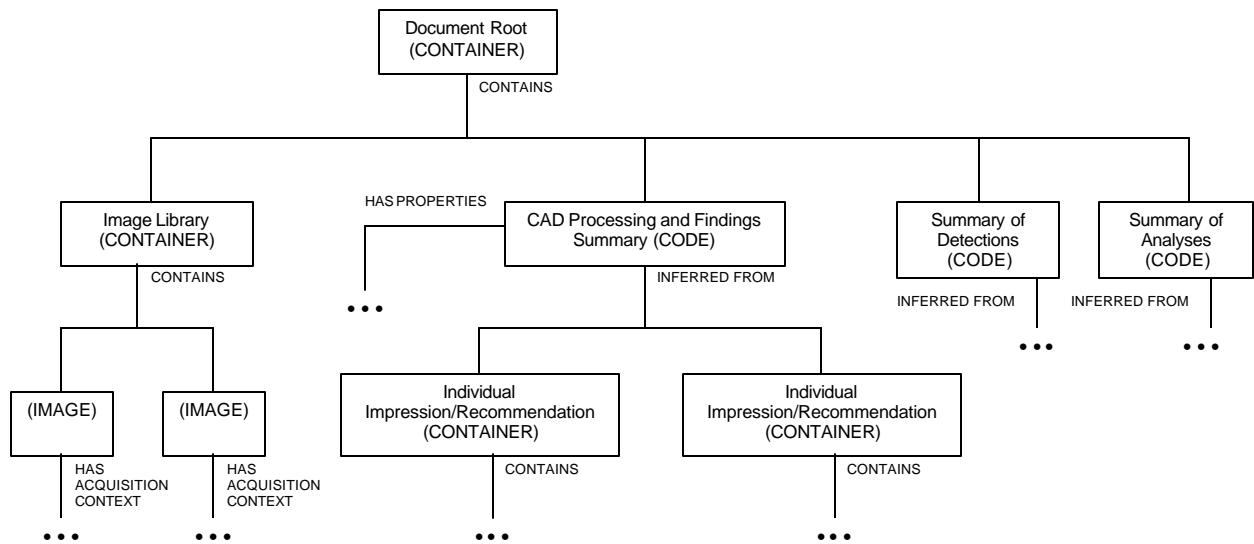

Figure L.1-1: Top Levels of Mammography CAD SR Content Tree

The Document Root, Image Library, Summaries of Detections and Analyses, and CAD Processing and Findings Summary sub-trees together form the content tree of the Mammography CAD SR IOD.

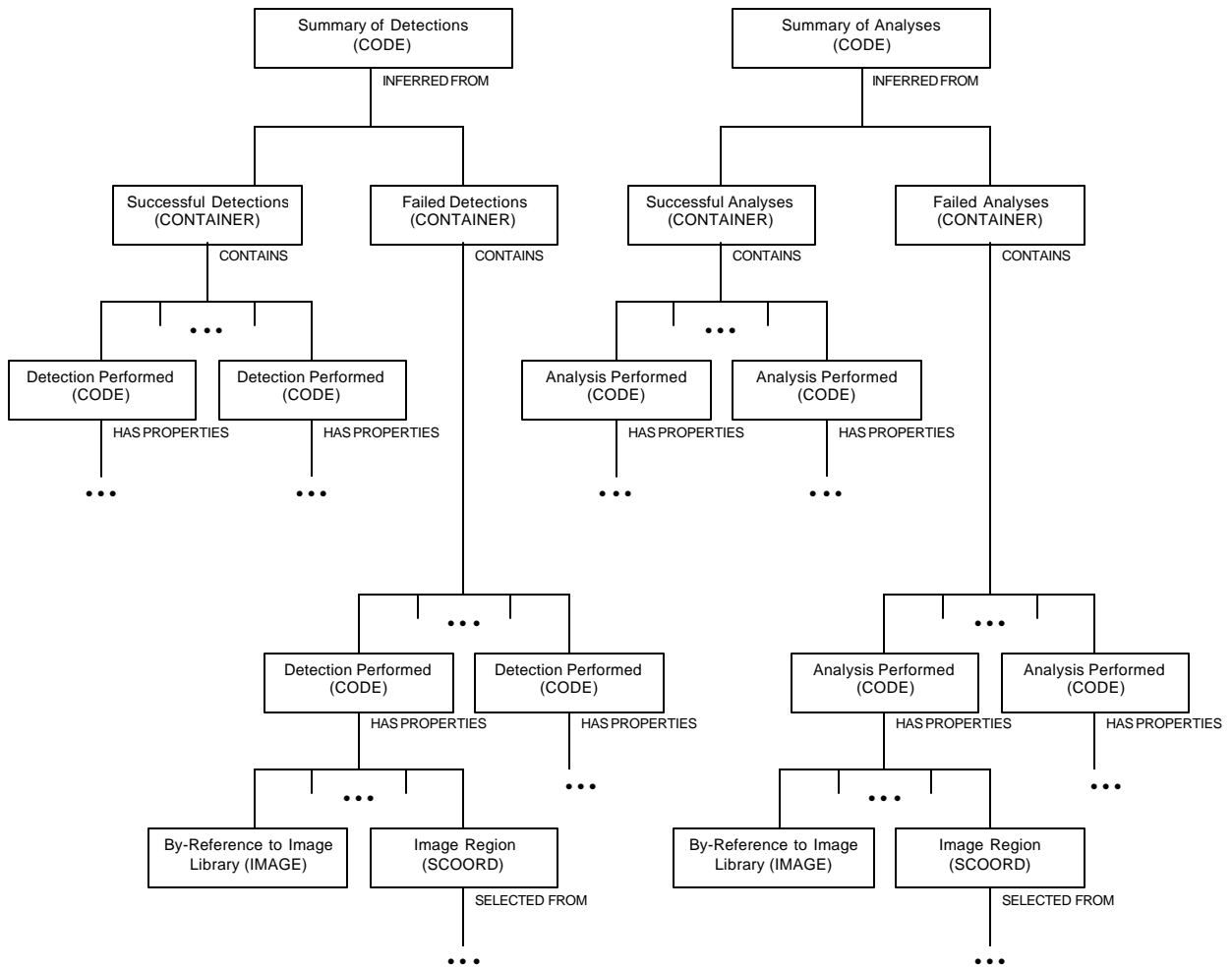

Figure L.1-2: Summary of Detections and Analyses Levels of Mammography CAD SR Content Tree

The Summary of Detections and Summary of Analyses sub-trees identify the algorithms used and the work done by the mammography CAD device, and whether or not each process was performed on one or more entire images or selected regions of images. The findings of the detections and analyses are not encoded in the summary sub-trees, but rather in the Overall Impression/Recommendation sub-tree. Mammography CAD processing may produce no findings, in which case the sub-trees of the Overall Impression/Recommendation sub-tree are incompletely populated. This occurs in the following situations:

- a. All algorithms succeeded, but no findings resulted
- b. Some algorithms succeeded, some failed, but no findings resulted
- c. All algorithms failed

Note 1: If the tree contains no Individual Impression/Recommendation nodes and all attempted detections and analyses succeeded then the mammography CAD device made no findings.

Note 2: Detections and Analyses that are not attempted are not listed in the Summary of Detections and Summary of Analyses trees.

Note 3: If the code value of the Summary of Detections or Summary of Analyses codes in TID 4000 is "Not Attempted" then no detail is provided as to which algorithms were not attempted.

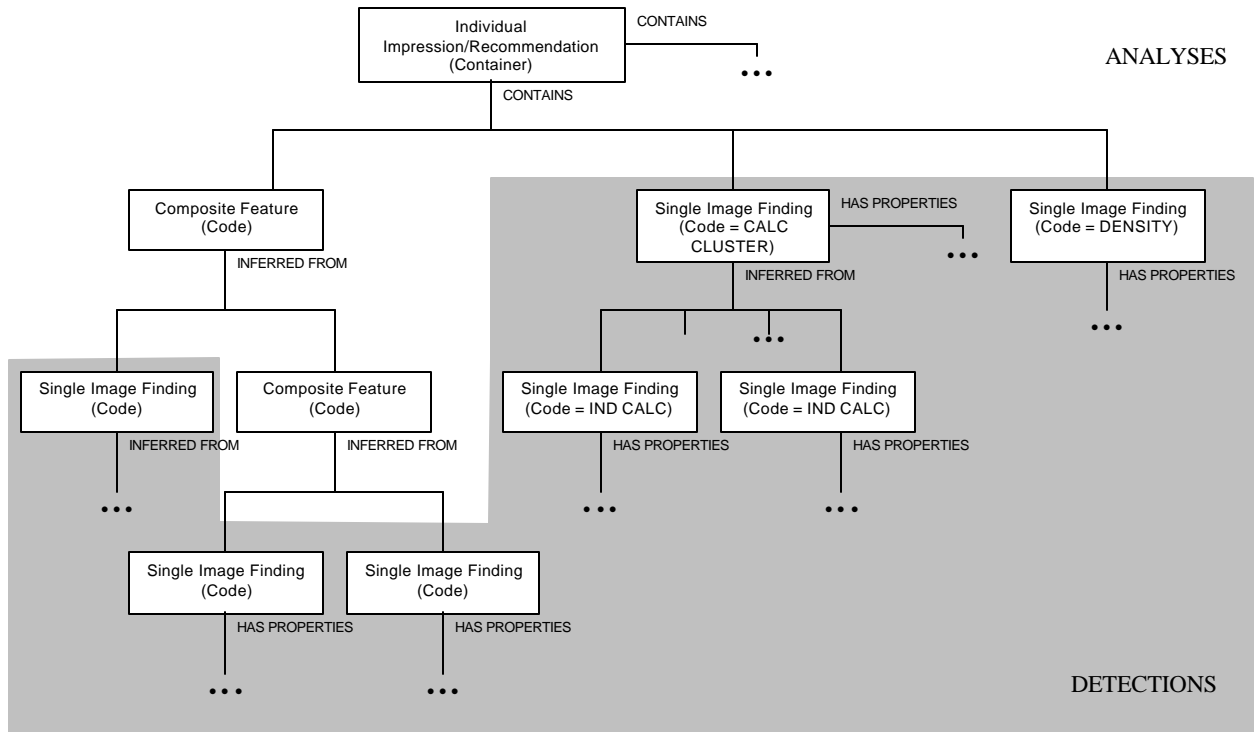

Figure L.1-3: Example of Individual Impression/Recommendation Levels of Mammography CAD SR Content Tree

The shaded area in Figure L.1-3 demarcates information resulting from Detection, whereas the unshaded area is information resulting from Analysis. This distinction is used in determining whether to place algorithm identification information in the Summary of Detections or Summary of Analyses sub-trees.

The clustering of calcifications within a single image is considered to be a Detection process which results in a Single Image Finding. The spatial correlation of a calcification cluster in two views, resulting in a Composite Feature, is considered Analysis. The clustering of calcifications in a single image is the only circumstance in which a Single Image Finding can result from the combination of other Single Image Findings, which must be Individual Calcifications.

Once a Single Image Finding or Composite Feature has been instantiated, it may be referenced by any number of Composite Features higher in the tree.

L.2 Mammography CAD SR Observation Context Encoding

- Any content item in the Content tree that has been inserted (i.e., duplicated) from another SR object instance has a HAS OBS CONTEXT relationship to one or more content items that describe the context of the SR object instance from which it originated. This mechanism may be used to combine reports (e.g., Mammography CAD 1, Mammography CAD 2, Human).
- By-reference relationships within Single Image Findings and Composite Features paraphrased from prior Mammography CAD SR objects need to be updated to properly reference Image Library Entries carried from the prior object to their new positions in the present object.

The Impression/Recommendation section of the SR Document Content tree of a Mammography CAD SR IOD may contain a mixture of current and prior single image findings and composite features. The content items from current and prior contexts are target content items that have a by-

value INFERRED FROM relationship to a Composite Feature content item. Content items that come from a context other than the Initial Observation Context have a HAS OBS CONTEXT relationship to target content items that describe the context of the source document.

In Figure L.2-1, Composite Feature and Single Image Finding are current, and Single Image Finding (from Prior) is duplicated from a prior document.

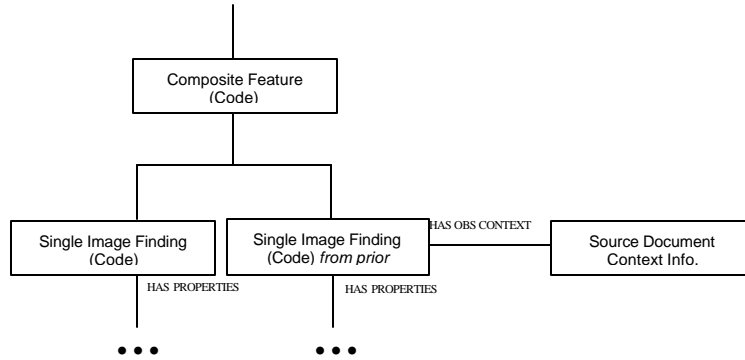

Figure L.2-1: Example of Use of Observation Context

L.3 Mammography CAD SR Examples

The following is a simple and non-comprehensive illustration of an encoding of the Mammography CAD SR IOD for Mammography computer aided detection results. For brevity, some Mandatory content items are not included, such as several acquisition context content items for the images in the Image Library.

Example 1: Calcification and Mass Detection with No Findings

A mammography CAD device processes a typical screening mammography case, i.e., there are four films and no cancer. Mammography CAD runs both density and calcification detection successfully and finds nothing. The mammograms resemble:

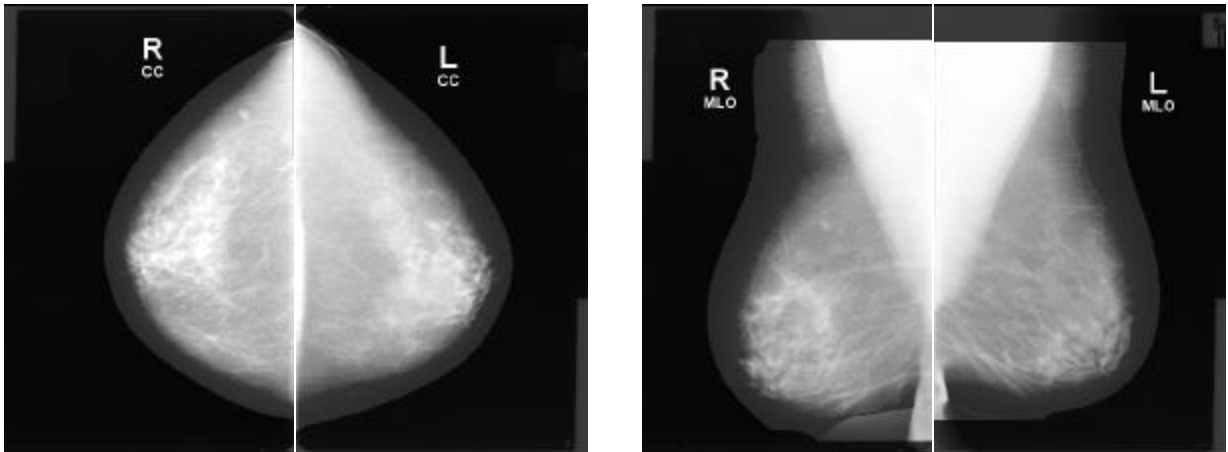

Figure L.3-1: Mammograms as Described in Example 1

The content tree structure would resemble:

Node	Code Meaning of Concept Name	Code Meaning or Example Value	TID
1	Mammography CAD Report		4000
1.1	Image Library		4000
1.1.1		IMAGE 1	4020
1.1.1.1	Image Laterality	Right	4020
1.1.1.2	Image View	Cranio-caudal	4020
1.1.1.3	Study Date	19980101	4020
1.1.2		IMAGE 2	4020
1.1.2.1	Image Laterality	Left	4020
1.1.2.2	Image View	Cranio-caudal	4020
1.1.2.3	Study Date	19980101	4020
1.1.3		IMAGE 3	4020
1.1.3.1	Image Laterality	Right	4020
1.1.3.2	Image View	Medio-lateral oblique	4020
1.1.3.3	Study Date	19980101	4020
1.1.4		IMAGE 4	4020
1.1.4.1	Image Laterality	Left	4020
1.1.4.2	Image View	Medio-lateral oblique	4020
1.1.4.3	Study Date	19980101	4020
1.2	CAD Processing and Findings Summary	All algorithms succeeded; without findings	4001
1.3	Summary of Detections	Succeeded	4000
1.3.1	Successful Detections		4015
1.3.1.1	Detection Performed	Density	4017
1.3.1.1.1	Algorithm Name	"Density Detector"	4019
1.3.1.1.2	Algorithm Version	"V3.7"	4019
1.3.1.1.3		Reference to node 1.1.1	4017
1.3.1.1.4		Reference to node 1.1.2	4017
1.3.1.1.5		Reference to node 1.1.3	4017
1.3.1.1.6		Reference to node 1.1.4	4017
1.3.1.2	Detection Performed	Individual Calcification	4017

Node	Code Meaning of Concept Name	Code Meaning or Example Value	TID
1.3.1.2.1	Algorithm Name	"Calc Detector"	4019
1.3.1.2.2	Algorithm Version	"V2.4"	4019
1.3.1.2.3		Reference to node 1.1.1	4017
1.3.1.2.4		Reference to node 1.1.2	4017
1.3.1.2.5		Reference to node 1.1.3	4017
1.3.1.2.6		Reference to node 1.1.4	4017
1.4	Summary of Analyses	Not Attempted	4000

Example 2: Calcification and Mass Detection with Findings

A mammography CAD device processes a screening mammography case with four films and a mass in the left breast. Mammography CAD runs both density and calcification detection successfully. It finds two densities in the LCC, one density in the LMLO, a cluster of two calcifications in the RCC and a cluster of 20 calcifications in the RMLO. It performs two clustering algorithms. One identifies individual calcifications and then clusters them, and the second simply detects calcification clusters. It performs mass correlation and combines one of the LCC densities and the LMLO density into a mass; the other LCC density is flagged Not for Presentation, therefore not intended for display to the end-user. The mammograms resemble:

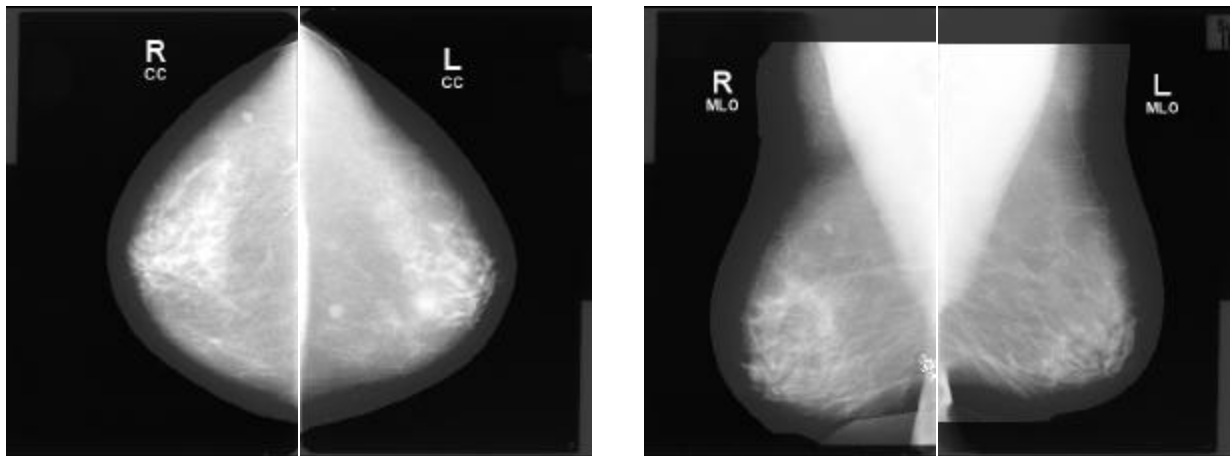

Figure L.3-2: Mammograms as Described in Example 2

The content tree structure in this example is complex. Structural illustrations of portions of the content tree are placed within the content tree table to show the relationships of data within the tree. Some content items are duplicated (and shown in boldface) to facilitate use of the diagrams.

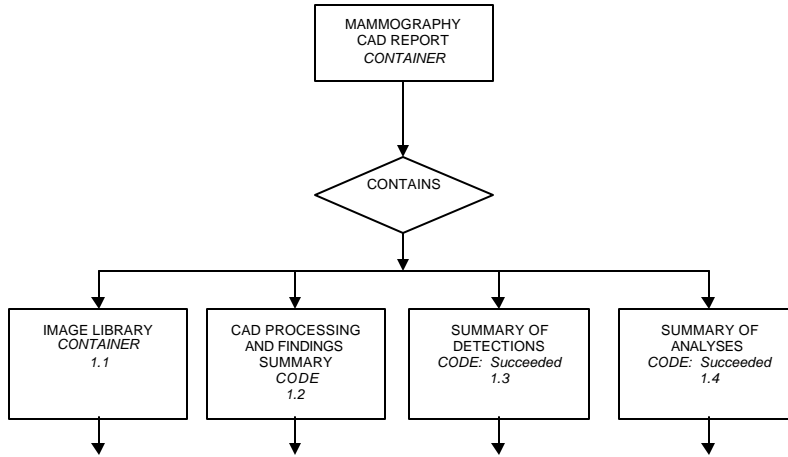

Figure L.3-3: Content Tree Root of Example 2 Content Tree

Node	Code Meaning of Concept Name	Code Meaning or Example Value	TID
1	Mammography CAD Report		4000
1.1	Image Library		4000
1.2	CAD Processing and Findings Summary	All algorithms succeeded; with findings	4001
1.3	Summary of Detections	Succeeded	4000
1.4	Summary of Analyses	Succeeded	4000

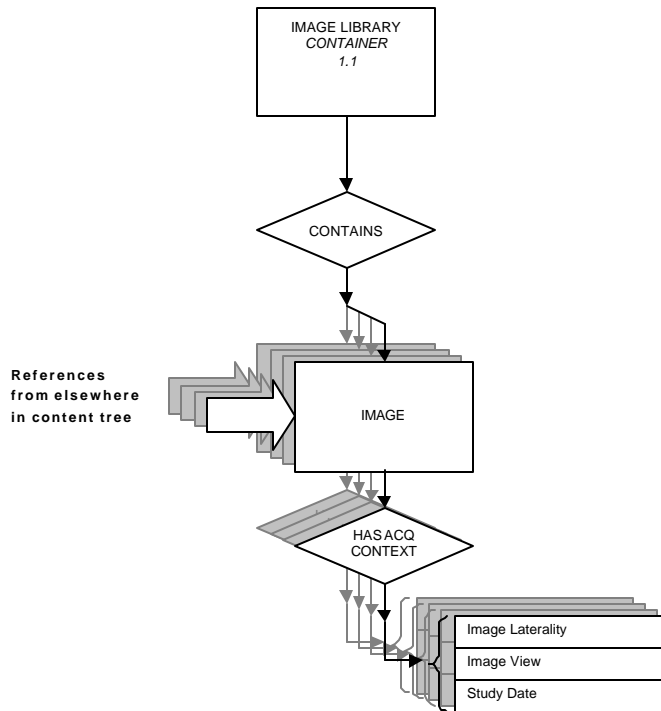

Figure L.3-4: Image Library Branch of Example 2 Content Tree

Node	Code Meaning of Concept Name	Code Meaning or Example Value	TID
1.1	Image Library		4000
1.1.1		IMAGE 1	4020
1.1.1.1	Image Laterality	Right	4020
1.1.1.2	Image View	Cranio-caudal	4020
1.1.1.3	Study Date	19990101	4020
1.1.2		IMAGE 2	4020
1.1.2.1	Image Laterality	Left	4020
1.1.2.2	Image View	Cranio-caudal	4020
1.1.2.3	Study Date	19990101	4020
1.1.3		IMAGE 3	4020
1.1.3.1	Image Laterality	Right	4020
1.1.3.2	Image View	Medio-lateral oblique	4020
1.1.3.3	Study Date	19990101	4020
1.1.4		IMAGE 4	4020
1.1.4.1	Image Laterality	Left	4020
1.1.4.2	Image View	Medio-lateral oblique	4020
1.1.4.3	Study Date	19990101	4020

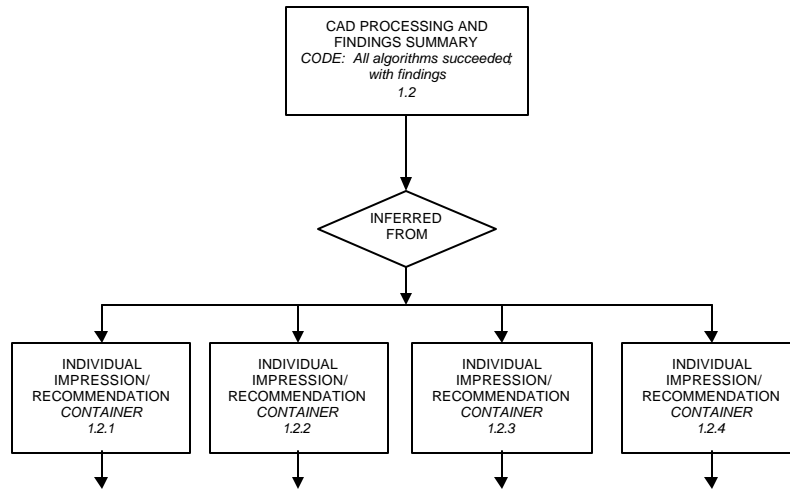

Figure L.3-5: CAD Processing and Findings Summary Bifurcation of Example 2 Content Tree

Node	Code Meaning of Concept Name	Code Meaning or Example Value	TID
------	------------------------------	-------------------------------	-----

Node	Code Meaning of Concept Name	Code Meaning or Example Value	TID
1.2	CAD Processing and Findings Summary	All algorithms succeeded; with findings	4001
1.2.1	Individual Impression/Recommendation		4003
1.2.2	Individual Impression/Recommendation		4003
1.2.3	Individual Impression/Recommendation		4003
1.2.4	Individual Impression/Recommendation		4003

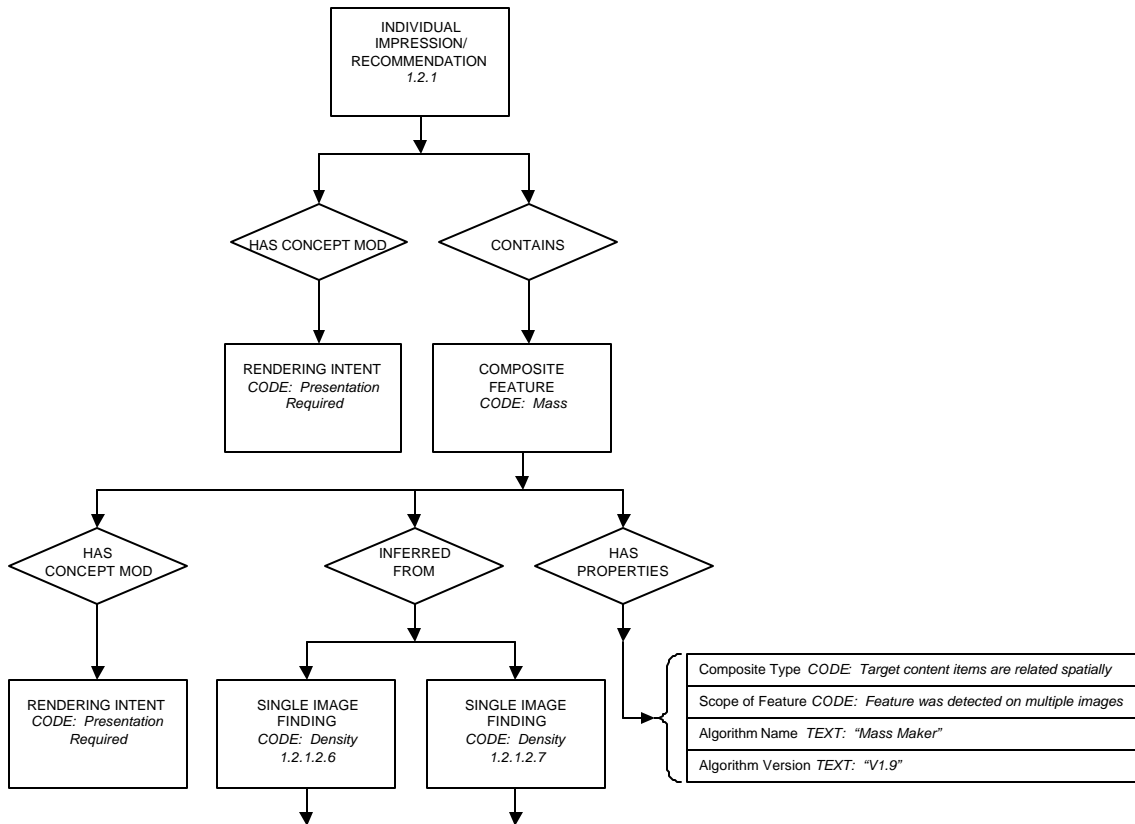

Figure L.3-6: Individual Impression/Recommendation 1.2.1 from Example 2 Content Tree

Node	Code Meaning of Concept Name	Code Meaning or Example Value	TID
1.2.1	Individual Impression/Recommendation		4003
1.2.1.1	Rendering Intent	Presentation Required	4003
1.2.1.2	Composite Feature	Mass	4004
1.2.1.2.1	Rendering Intent	Presentation Required	4004
1.2.1.2.2	Composite type	Target content items are related spatially	4005

Node	Code Meaning of Concept Name	Code Meaning or Example Value	TID
1.2.1.2.3	Scope of Feature	Feature was detected on multiple images	4005
1.2.1.2.4	Algorithm Name	"Mass Maker"	4019
1.2.1.2.5	Algorithm Version	"V1.9"	4019
1.2.1.2.6	Single Image Finding	Density	4006
1.2.1.2.7	Single Image Finding	Density	4006

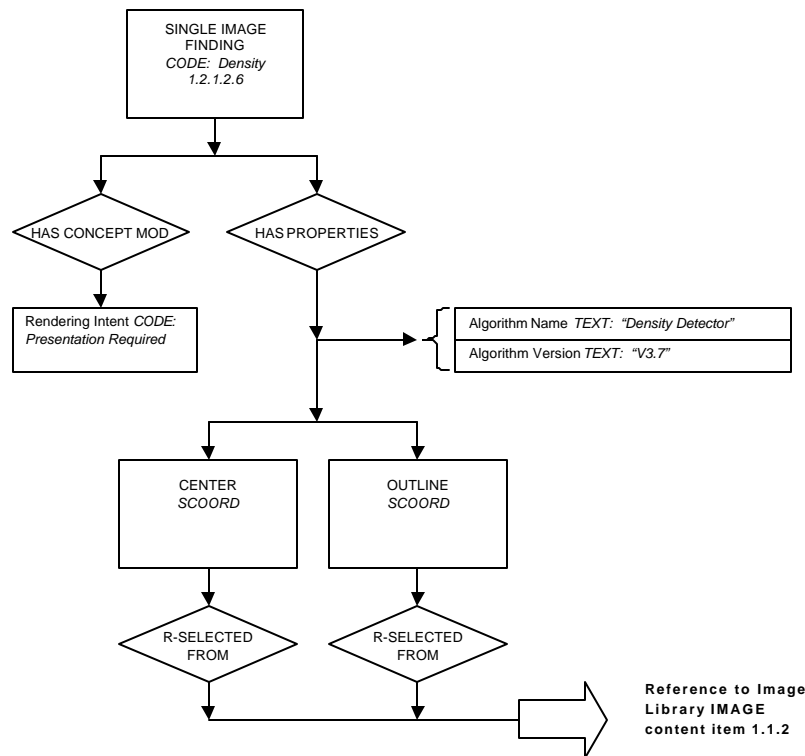

Figure L.3-7: Single Image Finding Density 1.2.1.2.6 from Example 2 Content Tree

Node	Code Meaning of Concept Name	Code Meaning or Example Value	TID
1.2.1.2.6	Single Image Finding	Density	4006
1.2.1.2.6.1	Rendering Intent	Presentation Required	4006
1.2.1.2.6.2	Algorithm Name	"Density Detector"	4019
1.2.1.2.6.3	Algorithm Version	"V3.7"	4019
1.2.1.2.6.4	Center	POINT	4021
1.2.1.2.6.4.1		Reference to node 1.1.2	4021
1.2.1.2.6.5	Outline	SCOORD	4021
1.2.1.2.6.5.1		Reference to node 1.1.2	4021

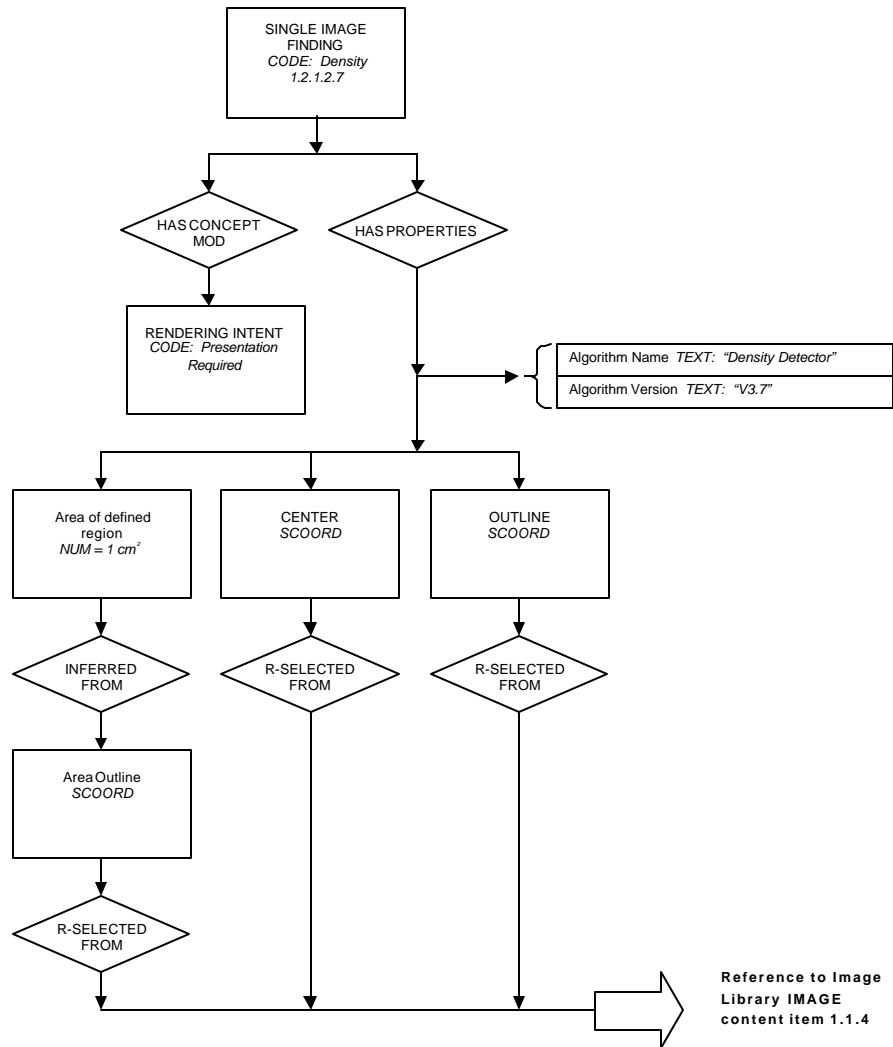

Figure L.3-8: Single Image Finding Density 1.2.1.2.7 from Example 2 Content Tree

Node	Code Meaning of Concept Name	Code Meaning or Example Value	TID
1.2.1.2.7	Single Image Finding	Density	4006
1.2.1.2.7.1	Rendering Intent	Presentation Required	4006
1.2.1.2.7.2	Algorithm Name	"Density Detector"	4019
1.2.1.2.7.3	Algorithm Version	"V3.7"	4019
1.2.1.2.7.4	Center	POINT	4021
1.2.1.2.7.4.1		Reference to node 1.1.4	4021
1.2.1.2.7.5	Outline	SCOORD	4021
1.2.1.2.7.5.1		Reference to node 1.1.4	4021
1.2.1.2.7.6	Area of Defined Region	1 cm ²	1401

Node	Code Meaning of Concept Name	Code Meaning or Example Value	TID
1.2.1.2.7.6.1	Area Outline	SCOORD	1401
1.2.1.2.7.6.1.1		Reference to node 1.1.4	1401

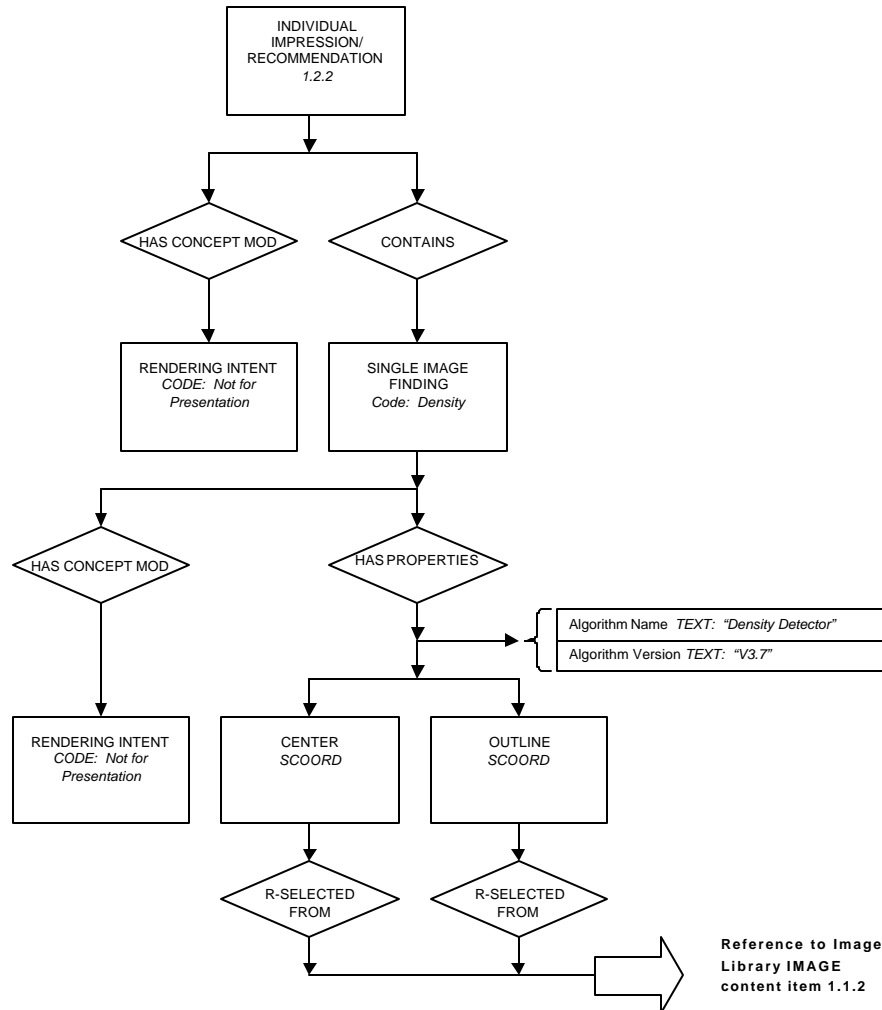

Figure L.3-9: Individual Impression/Recommendation 1.2.2 from Example 2 Content Tree

Node	Code Meaning of Concept Name	Code Meaning or Example Value	TID
1.2.2	Individual Impression/Recommendation		4003
1.2.2.1	Rendering Intent	Not for Presentation	4003
1.2.2.2	Single Image Finding	Density	4006
1.2.2.2.1	Rendering Intent	Not for Presentation	4006
1.2.2.2.2	Algorithm Name	"Density Detector"	4019
1.2.2.2.3	Algorithm Version	"V3.7"	4019

Node	Code Meaning of Concept Name	Code Meaning or Example Value	TID
1.2.2.2.4	Center	POINT	4021
1.2.2.2.4.1		Reference to node 1.1.2	4021
1.2.2.2.5	Outline	SCOORD	4021
1.2.2.2.5.1		Reference to node 1.1.2	4021

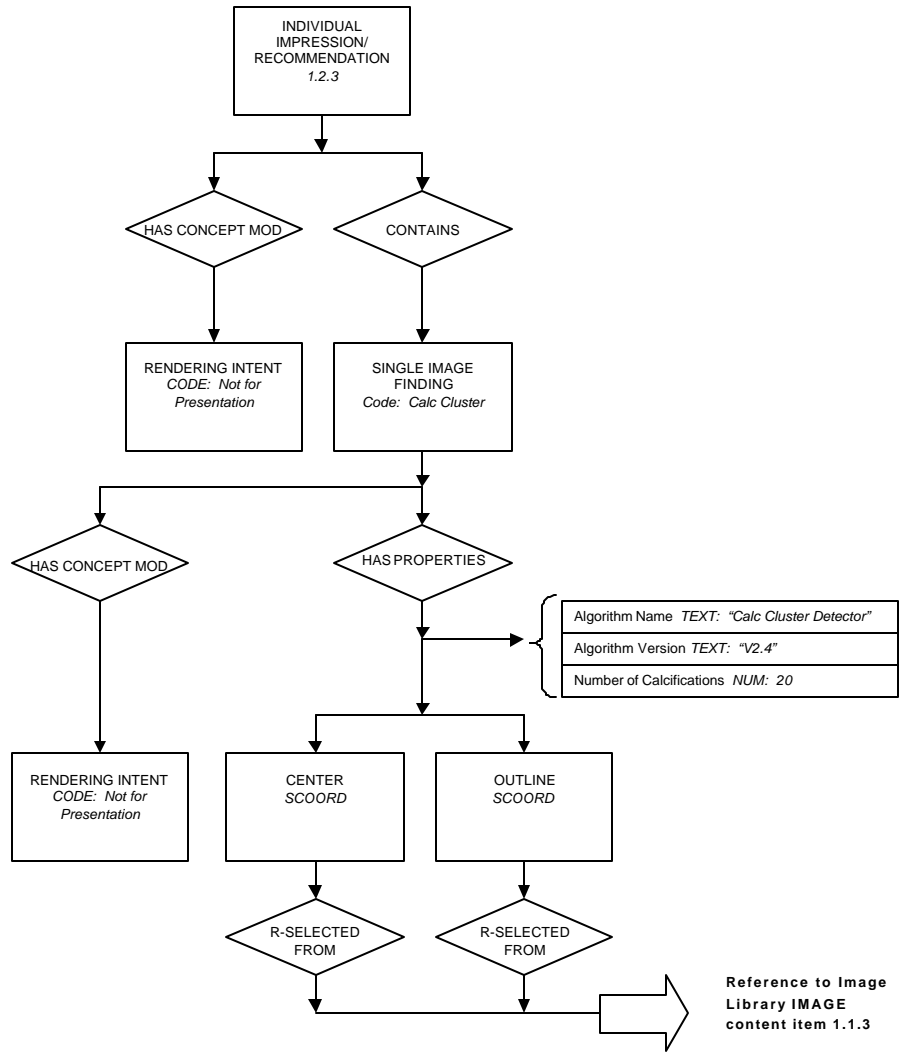

Figure L.3-10: Individual Impression/Recommendation 1.2.3 from Example 2 Content Tree

Node	Code Meaning of Concept Name	Code Meaning or Example Value	TID
1.2.3	Individual Impression/Recommendation		4003
1.2.3.1	Rendering Intent	Presentation Required	4003
1.2.3.2	Single Image Finding	Calcification Cluster	4006

Node	Code Meaning of Concept Name	Code Meaning or Example Value	TID
1.2.3.2.1	Rendering Intent	Presentation Required	4006
1.2.3.2.2	Algorithm Name	"Calc Cluster Detector"	4019
1.2.3.2.3	Algorithm Version	"V2.4"	4019
1.2.3.2.4	Center	POINT	4021
1.2.3.2.4.1		Reference to node 1.1.3	4021
1.2.3.2.5	Outline	SCOORD	4021
1.2.3.2.5.1		Reference to node 1.1.3	4021
1.2.3.2.6	Number of Calcifications	20	4010

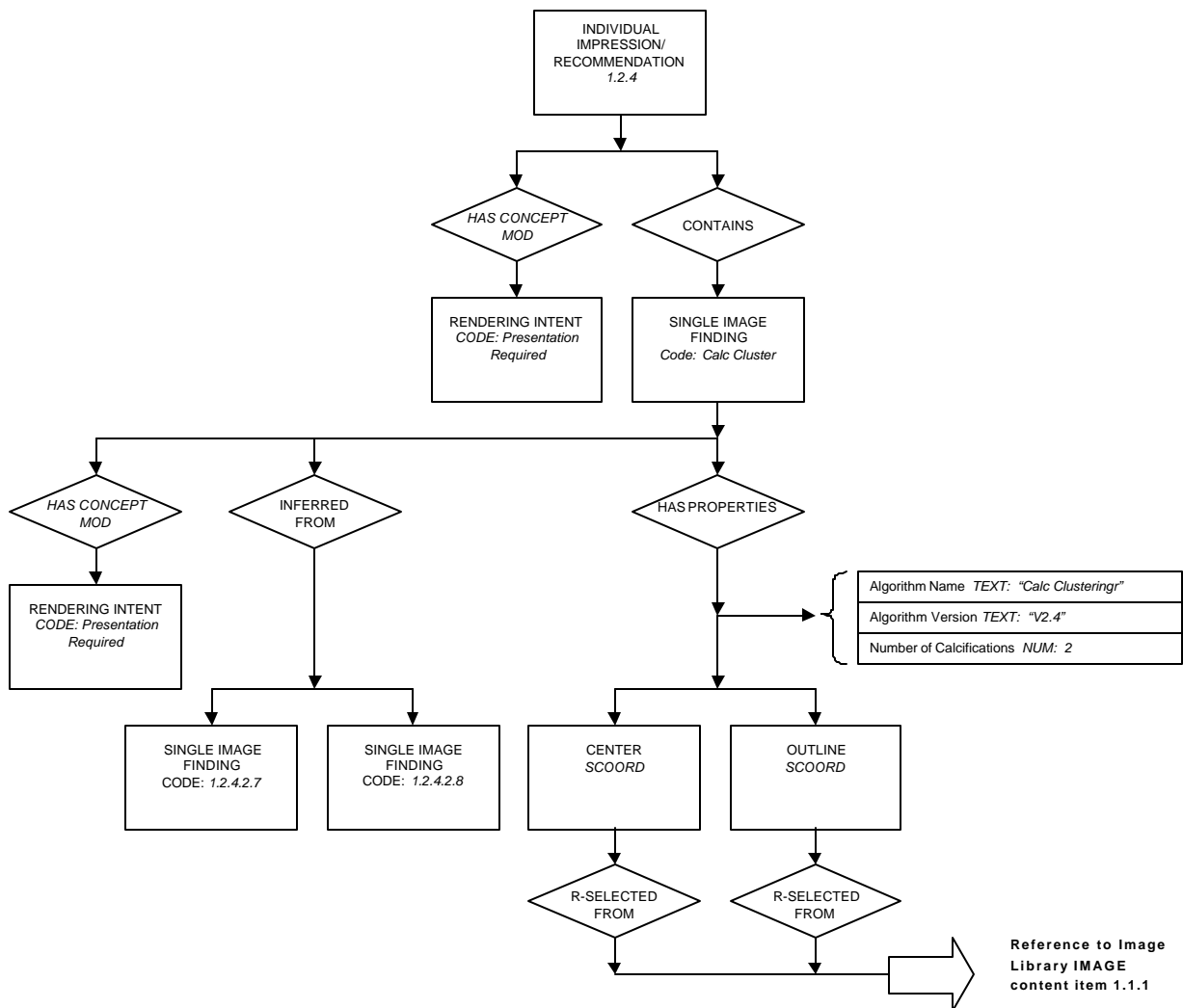

Figure L.3-11: Individual Impression/Recommendation 1.2.4 from Example 2 Content Tree

Node	Code Meaning of Concept Name	Code Meaning or Example Value	TID
1.2.4	Individual Impression/Recommendation		4003
1.2.4.1	Rendering Intent	Presentation Required	4003
1.2.4.2	Single Image Finding	Calcification Cluster	4006
1.2.4.2.1	Rendering Intent	Presentation Required	4006
1.2.4.2.2	Algorithm Name	"Calc Clustering"	4019
1.2.4.2.3	Algorithm Version	"V2.4"	4019
1.2.4.2.4	Center	POINT	4021
1.2.4.2.4.1		Reference to node 1.1.1	4021
1.2.4.2.5	Outline	SCOORD	4021
1.2.4.2.5.1		Reference to node 1.1.1	4021
1.2.4.2.6	Number of Calcifications	2	4010

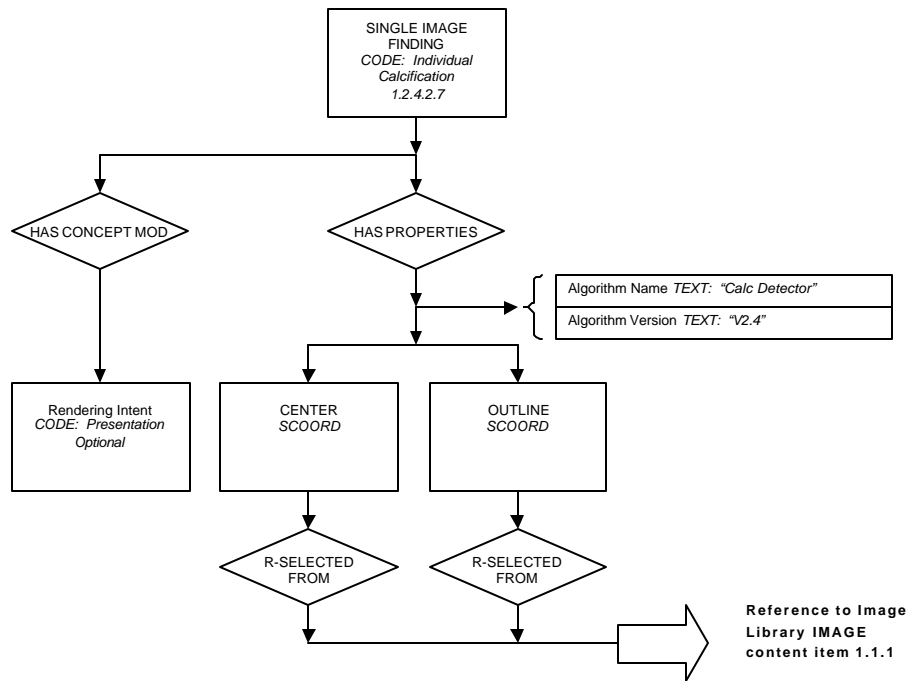

Figure L.3-12: Single Image Finding 1.2.4.2.7 from Example 2 Content Tree

Node	Code Meaning of Concept Name	Code Meaning or Example Value	TID
1.2.4.2.7	Single Image Finding	Individual Calcification	4006
1.2.4.2.7.1	Rendering Intent	Presentation Optional	4006

Node	Code Meaning of Concept Name	Code Meaning or Example Value	TID
1.2.4.2.7.2	Algorithm Name	"Calc Detector"	4019
1.2.4.2.7.3	Algorithm Version	"V2.4"	4019
1.2.4.2.7.4	Center	POINT	4021
1.2.4.2.7.4.1		Reference to node 1.1.1	4021
1.2.4.2.7.5	Outline	SCOORD	4021
1.2.4.2.7.5.1		Reference to node 1.1.1	4021

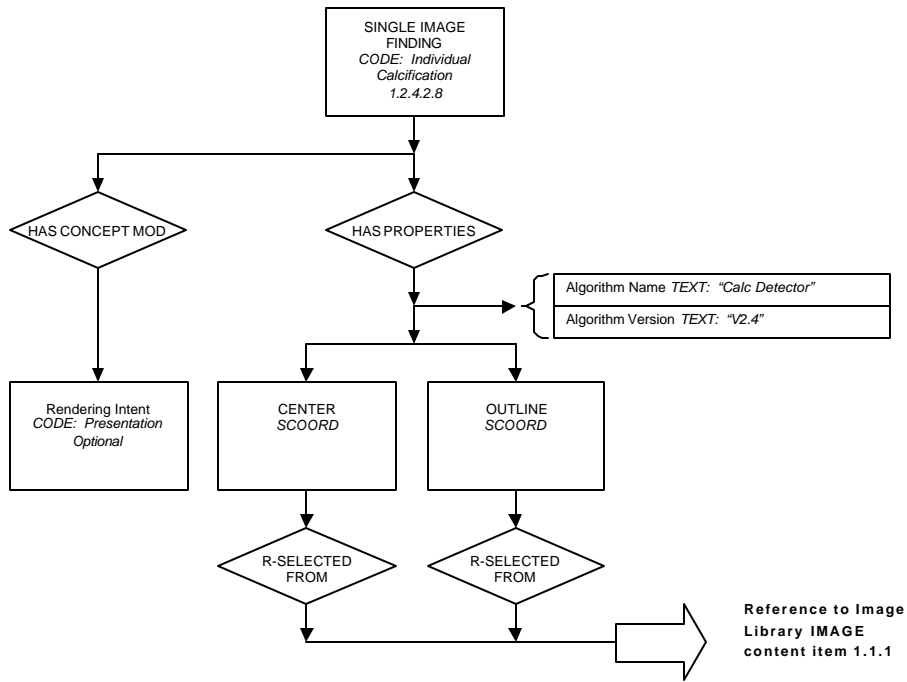

Figure L.3-13: Single Image Finding 1.2.4.2.8 from Example 2 Content Tree

Node	Code Meaning of Concept Name	Code Meaning or Example Value	TID
1.2.4.2.8	Single Image Finding	Individual Calcification	4006
1.2.4.2.8.1	Rendering Intent	Presentation Optional	4006
1.2.4.2.8.2	Algorithm Name	"Calc Detector"	4019
1.2.4.2.8.3	Algorithm Version	"V2.4"	4019
1.2.4.2.8.4	Center	POINT	4021
1.2.4.2.8.4.1		Reference to node 1.1.1	4021
1.2.4.2.8.5	Outline	SCOORD	4021
1.2.4.2.8.5.1		Reference to node 1.1.1	4021

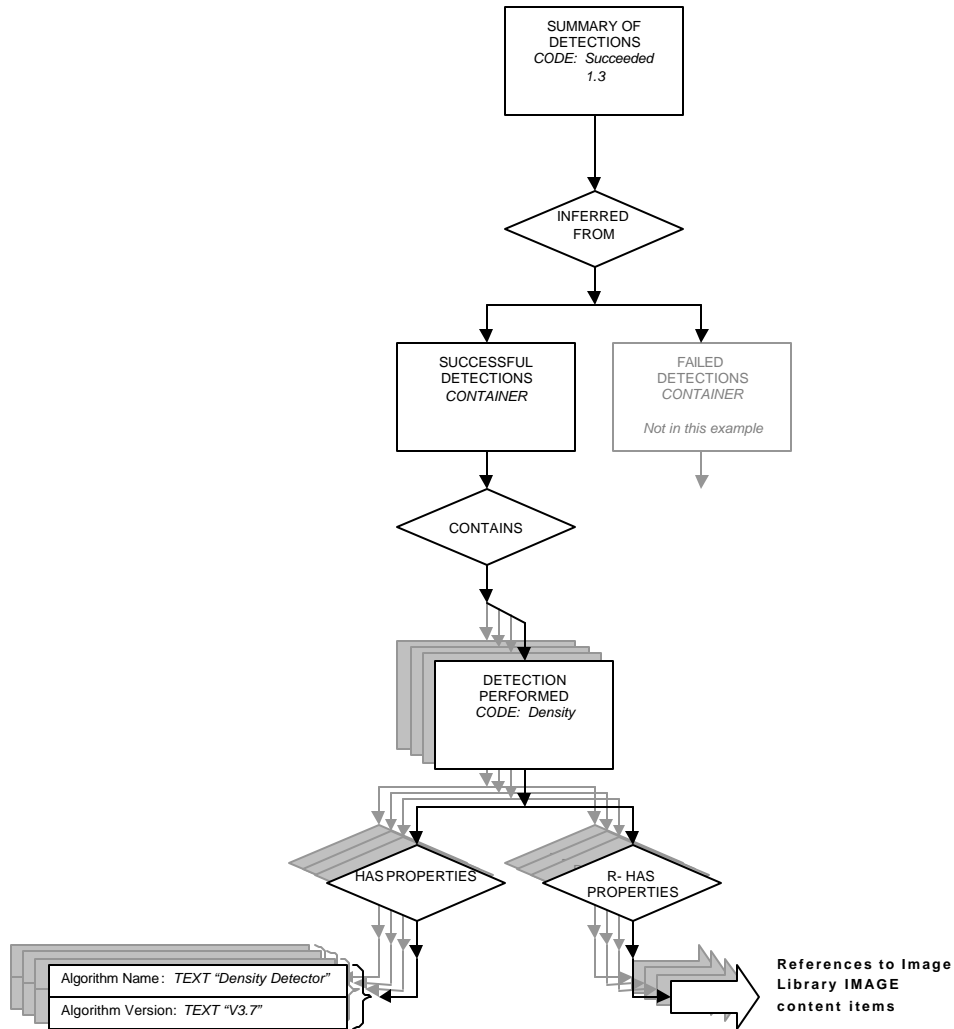

Figure L.3-14: Summary of Detections Branch of Example 2 Content Tree

Node	Code Meaning of Concept Name	Code Meaning or Example Value	TID
1.3	Summary of Detections	Succeeded	4000
1.3.1	Successful Detections		4015
1.3.1.1	Detection Performed	Density	4017
1.3.1.1.1	Algorithm Name	"Density Detector"	4019
1.3.1.1.2	Algorithm Version	"V3.7"	4019
1.3.1.1.3		Reference to node 1.1.1	4017
1.3.1.1.4		Reference to node 1.1.2	4017
1.3.1.1.5		Reference to node 1.1.3	4017
1.3.1.1.6		Reference to node 1.1.4	4017

Node	Code Meaning of Concept Name	Code Meaning or Example Value	TID
1.3.1.2	Detection Performed	Individual Calcification	4017
1.3.1.2.1	Algorithm Name	"Calc Detector"	4019
1.3.1.2.2	Algorithm Version	"V2.4"	4019
1.3.1.2.3		Reference to node 1.1.1	4017
1.3.1.2.4		Reference to node 1.1.2	4017
1.3.1.2.5		Reference to node 1.1.3	4017
1.3.1.2.6		Reference to node 1.1.4	4017
1.3.1.3	Detection Performed	Calcification Cluster	4017
1.3.1.3.1	Algorithm Name	"Calc Clustering"	4019
1.3.1.3.2	Algorithm Version	"V2.4"	4019
1.3.1.3.3		Reference to node 1.1.1	4017
1.3.1.4	Detection Performed	Calcification Cluster	4017
1.3.1.4.1	Algorithm Name	"Calc Cluster Detector"	4019
1.3.1.4.2	Algorithm Version	"V2.4"	4019
1.3.1.4.3		Reference to node 1.1.1	4017
1.3.1.4.4		Reference to node 1.1.2	4017
1.3.1.4.5		Reference to node 1.1.3	4017
1.3.1.4.6		Reference to node 1.1.4	4017

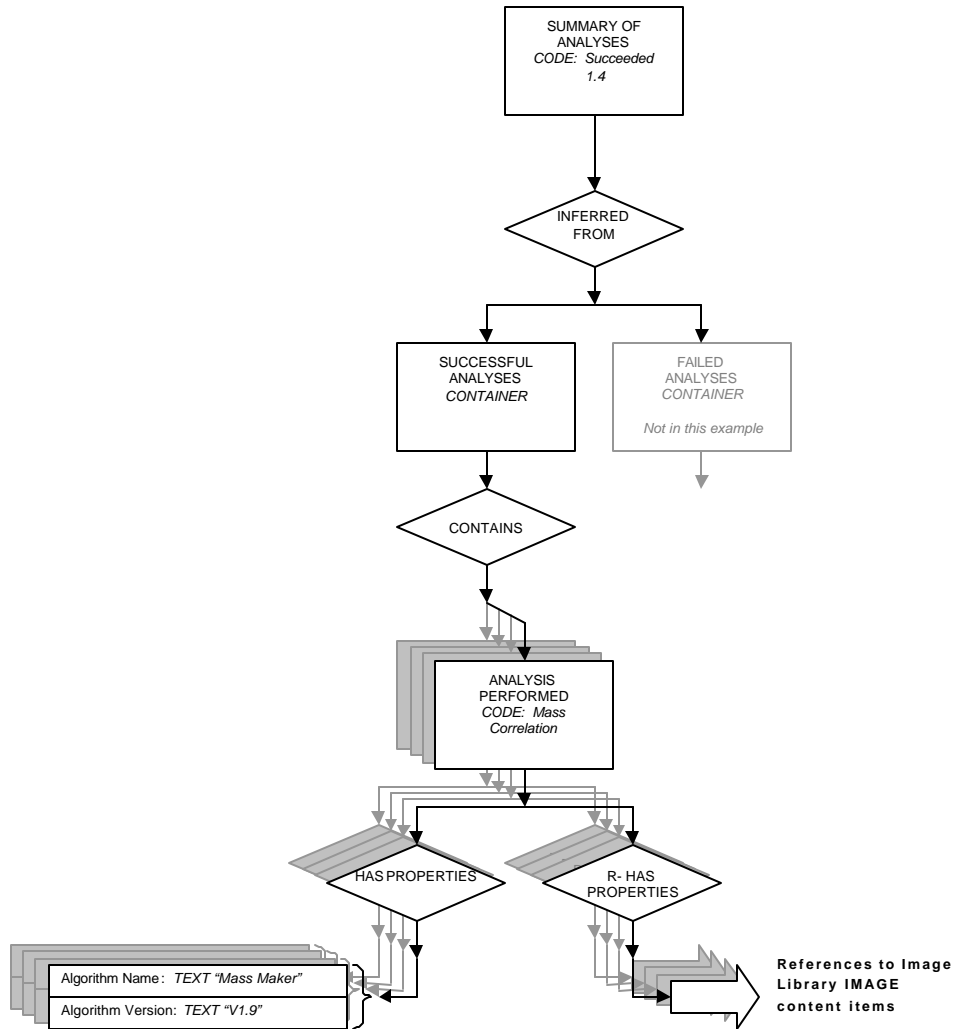

Figure L.3-15: Summary of Analyses Branch of Example 2 Content Tree

Node	Code Meaning of Concept Name	Code Meaning or Example Value	TID
1.4	Summary of Analyses	Succeeded	4000
1.4.1	Successful Analyses		4016
1.4.1.1	Analysis Performed	Mass Correlation	4018
1.4.1.1.1	Algorithm Name	"Mass Maker"	4019
1.4.1.1.2	Algorithm Version	"V1.9"	4019
1.4.1.1.3		Reference to node 1.1.2	4018
1.4.1.1.4		Reference to node 1.1.4	4018

Example 3: Calcification and Mass Detection, Temporal Differencing with Findings

The patient in Example 2 returns for another mammogram. A more comprehensive mammography CAD device processes the current mammogram; analyses are performed that determine some content items for Overall and Individual Impression/Recommendations. Portions of the prior mammography CAD report (Example 2) are incorporated into this report. In the current mammogram the number of calcifications in the RCC has increased, and the size of the mass in the left breast has increased from 1 to 4 cm².

PRIOR

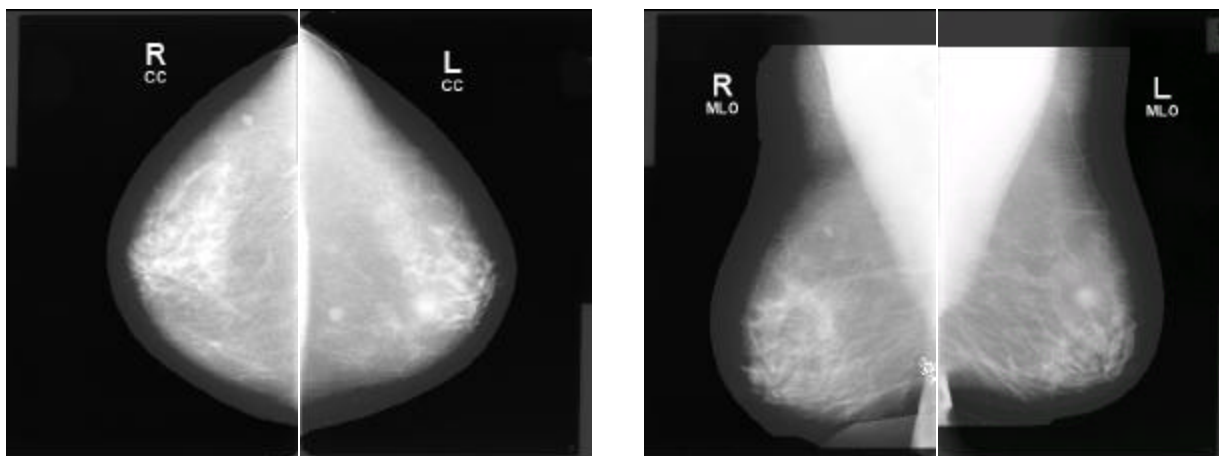

CURRENT

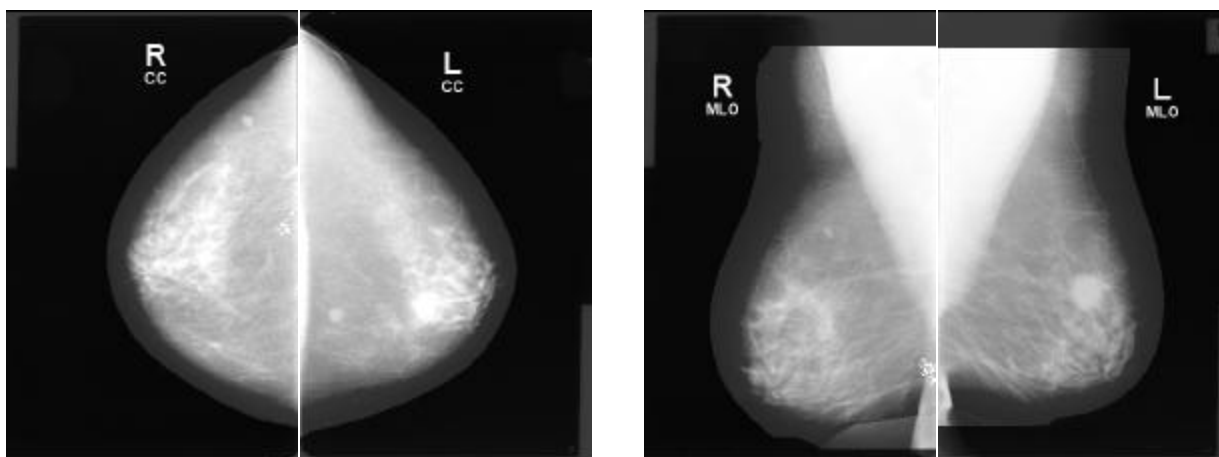

Figure L.3-16: Mammograms as Described in Example 3

Italicized entries (xxx) in the following table denote references to or by-value inclusion of content tree items reused from the prior Mammography CAD SR instance (Example 2).

Node	Code Meaning of Concept Name	Code Meaning or Example Value	TID
1	Mammography CAD Report		4000

Node	Code Meaning of Concept Name	Code Meaning or Example Value	TID

While the Image Library contains references to content tree items reused from the prior Mammography CAD SR instance, the images are actually used in the mammography CAD analysis and are therefore not italicized as indicated above.

Node	Code Meaning of Concept Name	Code Meaning or Example Value	TID
1.1	Image Library		4000
1.1.1		IMAGE 1	4020
1.1.1.1	Image Laterality	Right	4020
1.1.1.2	Image View	Cranio-caudal	4020
1.1.1.3	Study Date	20000101	4020
1.1.2		IMAGE 2	4020
1.1.2.1	Image Laterality	Left	4020
1.1.2.2	Image View	Cranio-caudal	4020
1.1.2.3	Study Date	20000101	4020
1.1.3		IMAGE 3	4020
1.1.3.1	Image Laterality	Right	4020
1.1.3.2	Image View	Medio-lateral oblique	4020
1.1.3.3	Study Date	20000101	4020
1.1.4		IMAGE 4	4020
1.1.4.1	Image Laterality	Left	4020
1.1.4.2	Image View	Medio-lateral oblique	4020
1.1.4.3	Study Date	20000101	4020
1.1.5		IMAGE 5	4020
1.1.5.1	Image Laterality	Right	4020
1.1.5.2	Image View	Cranio-caudal	4020
1.1.5.3	Study Date	19990101	4020
1.1.6		IMAGE 6	4020
1.1.6.1	Image Laterality	Left	4020
1.1.6.2	Image View	Cranio-caudal	4020
1.1.6.3	Study Date	19990101	4020
1.1.7		IMAGE 7	4020
1.1.7.1	Image Laterality	Right	4020
1.1.7.2	Image View	Medio-lateral oblique	4020
1.1.7.3	Study Date	19990101	4020

Node	Code Meaning of Concept Name	Code Meaning or Example Value	TID
1.1.8		IMAGE 8	4020
1.1.8.1	Image Laterality	Left	4020
1.1.8.2	Image View	Medio-lateral oblique	4020
1.1.8.3	Study Date	19990101	4020

Current year content:

Node	Code Meaning of Concept Name	Code Meaning or Example Value	TID
1.2	CAD Processing and Findings Summary	All algorithms succeeded; with findings	4001
1.2.1	Assessment Category	4 – Suspicious abnormality, biopsy should be considered	4002
1.2.2	Recommend Follow-up Interval	0 days	4002
1.2.3	Algorithm Name	“Mammogram Analyzer”	4019
1.2.4	Algorithm Version	“V1.0”	4019
1.2.5	Individual Impression/Recommendation		4003
1.2.5.1	Rendering Intent	Presentation Required	4003
1.2.5.2	Differential Diagnosis/Impression	Increase in size	4002
1.2.5.3	Impression Description	“Worrisome increase in size”	4002
1.2.5.4	Recommended Follow-up	Needle localization and biopsy	4002
1.2.5.5	Certainty of impression	84%	4002
1.2.5.6	Algorithm Name	“Lesion Analyzer”	4019
1.2.5.7	Algorithm Version	“V1.0”	4019
1.2.5.8	Composite Feature	Mass	4004
1.2.5.8.1	Rendering Intent	Presentation Required	4004
1.2.5.8.2	Composite type	Target content items are related temporally	4005
1.2.5.8.3	Scope of Feature	Feature was detected on multiple images	4005
1.2.5.8.4	Algorithm Name	“Temporal Change”	4019
1.2.5.8.5	Algorithm Version	“V0.1”	4019
1.2.5.8.6	Certainty of Feature	91%	4005
1.2.5.8.7	Probability of Cancer	84%	4005

Node	Code Meaning of Concept Name	Code Meaning or Example Value	TID
1.2.5.8.8	Pathology	Lobular carcinoma in situ of breast	4005
1.2.5.8.9	Difference in Size	3 cm ²	4005
1.2.5.8.9.1		Reference to node 1.2.5.8.13.7.6	4005
1.2.5.8.9.2		Reference to node 1.2.5.8.14.8.6	4005
1.2.5.8.10	Lesion Density	High density	4005
1.2.5.8.11	Shape	Lobular	4005
1.2.5.8.12	Margins	Microlobulated	4005
1.2.5.8.13	Composite Feature	Mass	4004
1.2.5.8.13.1	Rendering Intent	Presentation Required	4004
1.2.5.8.13.2	Composite type	Target content items are related spatially	4005
1.2.5.8.13.3	Scope of Feature	Feature was detected on multiple images	4005
1.2.5.8.13.4	Algorithm Name	"Mass Maker"	4019
1.2.5.8.13.5	Algorithm Version	"V1.9"	4019
1.2.5.8.13.6	Single Image Finding	Density	4006
1.2.5.8.13.6.1	Rendering Intent	Presentation Required	4006
1.2.5.8.13.6.2	Algorithm Name	"Density Detector"	4019
1.2.5.8.13.6.3	Algorithm Version	"V3.7"	4019
1.2.5.8.13.6.4	Center	POINT	4021
1.2.5.8.13.6.4.1		Reference to node 1.1.2	4021
1.2.5.8.13.6.5	Outline	SCCOORD	4021
1.2.5.8.13.6.5.1		Reference to node 1.1.2	4021
1.2.5.8.13.7	Single Image Finding	Density	4006
1.2.5.8.13.7.1	Rendering Intent	Presentation Required	4006
1.2.5.8.13.7.2	Algorithm Name	"Density Detector"	4019
1.2.5.8.13.7.3	Algorithm Version	"V3.7"	4019
1.2.5.8.13.7.4	Center	POINT	4021
1.2.5.8.13.7.4.1		Reference to node 1.1.4	4021
1.2.5.8.13.7.5	Outline	SCCOORD	4021
1.2.5.8.13.7.5.1		Reference to node 1.1.4	4021

Node	Code Meaning of Concept Name	Code Meaning or Example Value	TID
1.2.5.8.13.7.6	Area of Defined Region	4 cm ²	1401
1.2.5.8.13.7.6.1	Area Outline	SCOORD	1401
1.2.5.8.13.7.6. 1.1		Reference to node 1.1.4	1401

Included content from prior mammography CAD report (see Example 2, starting with node 1.2.1.2)

Node	Code Meaning of Concept Name	Code Meaning or Example Value	TID
1.2.5.8.14	Composite Feature	Mass	4004
1.2.5.8.14.1	Rendering Intent	Presentation Required	4004
1.2.5.8.14.2	Composite type	Target content items are related spatially	4005
1.2.5.8.14.3	Scope of Feature	Feature was detected on multiple images	4005
1.2.5.8.14.4	Algorithm Name	"Mass Maker"	4019
1.2.5.8.14.5	Algorithm Version	"V1.9"	4019
1.2.5.8.14.6	[Observation Context content items]		4022
1.2.5.8.14.7	Single Image Finding	Density	4006
1.2.5.8.14.7.1	Rendering Intent	Presentation Required	4006
1.2.5.8.14.7.2	Algorithm Name	"Density Detector"	4019
1.2.5.8.14.7.3	Algorithm Version	"V3.7"	4019
1.2.5.8.14.7.4	Center	POINT	4021
1.2.5.8.14.7.4.1		Reference to node 1.1.6	4021
1.2.5.8.14.7.5	Outline	SCOORD	4021
1.2.5.8.14.7.5.1		Reference to node 1.1.6	4021
1.2.5.8.14.8	Single Image Finding	Density	4006
1.2.5.8.14.8.1	Rendering Intent	Presentation Required	4006
1.2.5.8.14.8.2	Algorithm Name	"Density Detector"	4019
1.2.5.8.14.8.3	Algorithm Version	"V3.7"	4019
1.2.5.8.14.8.4	Center	POINT	4021
1.2.5.8.14.8.4.1		Reference to node 1.1.8	4021
1.2.5.8.14.8.5	Outline	SCOORD	4021
1.2.5.8.14.8.5.1		Reference to node 1.1.8	4021
1.2.5.8.14.8.6	Area of Defined Region	1 cm ²	1401
1.2.5.8.14.8.6.1	Area Outline	SCOORD	1401
1.2.5.8.14.8.6.1.1		Reference to node 1.1.8	1401

More current year content:

Node	Code Meaning of Concept Name	Code Meaning or Example Value	TID
1.2.6	Individual Impression/Recommendation		4003
1.2.6.1	Rendering Intent	Not for Presentation	4003
1.2.6.2	Single Image Finding	Density	4006
1.2.6.2.1	Rendering Intent	Not for Presentation	4006
1.2.6.2.2	Algorithm Name	"Density Detector"	4019
1.2.6.2.3	Algorithm Version	"V3.7"	4019
1.2.6.2.4	Center	POINT	4021
1.2.6.2.4.1		Reference to node 1.1.2	4021
1.2.6.2.5	Outline	SCOORD	4021
1.2.6.2.5.1		Reference to node 1.1.2	4021
1.2.7	Individual Impression/Recommendation	INDIVIDUAL	4003
1.2.7.1	Rendering Intent	Presentation Required	4003
1.2.7.2	Single Image Finding	Calcification Cluster	4006
1.2.7.2.1	Rendering Intent	Presentation Required	4006
1.2.7.2.2	Algorithm Name	"Calc Cluster Detector"	4019
1.2.7.2.3	Algorithm Version	"V2.4"	4019
1.2.7.2.4	Center	POINT	4021
1.2.7.2.4.1		Reference to node 1.1.3	4021
1.2.7.2.5	Outline	SCOORD	4021
1.2.7.2.5.1		Reference to node 1.1.3	4021
1.2.7.2.6	Number of Calcifications	20	4010
1.2.8	Individual Impression/Recommendation		4003
1.2.8.1	Rendering Intent	Presentation Required	4003
1.2.8.2	Differential Diagnosis/Impression	Increase in number of calcifications	4002
1.2.8.3	Impression Description	"Calcification cluster has increased in size"	4002
1.2.8.4	Recommended Follow-up	Magnification views	4002
1.2.8.5	Certainty of impression	100%	4002
1.2.8.6	Algorithm Name	"Lesion Analyzer"	4019
1.2.8.7	Algorithm Version	"V1.0"	4019
1.2.8.8	Composite Feature	Calcification Cluster	4004
1.2.8.8.1	Rendering Intent	Presentation Required	4004

Node	Code Meaning of Concept Name	Code Meaning or Example Value	TID
1.2.8.8.2	Composite type	Target content items are related temporally	4005
1.2.8.8.3	Scope of Feature	Feature was detected on multiple images	4005
1.2.8.8.4	Algorithm Name	"Lesion Analyzer"	4019
1.2.8.8.5	Algorithm Version	"V1.0"	4019
1.2.8.8.6	Certainty of Feature	99%	4005
1.2.8.8.7	Probability of Cancer	54%	4005
1.2.8.8.8	Pathology	Intraductal carcinoma, low grade	4005
1.2.8.8.9	Difference in Number of calcifications	4	4005
1.2.8.8.9.1		Reference to node 1.2.8.8.12.6	4005
1.2.8.8.9.2		Reference to node 1.2.8.8.13.6	4005
1.2.8.8.10	Calcification type	Fine, linear, branching (casting)	4005
1.2.8.8.11	Calcification distribution	Grouped or clustered	4005
1.2.8.8.12	Single Image Finding	Calcification Cluster	4006
1.2.8.8.12.1	Rendering Intent	Presentation Required	4006
1.2.8.8.12.2	Algorithm Name	"Calc Clustering"	4019
1.2.8.8.12.3	Algorithm Version	"V2.4"	4019
1.2.8.8.12.4	Center	POINT	4021
1.2.8.8.12.4.1		Reference to node 1.1.1	4021
1.2.8.8.12.5	Outline	SCOORD	4021
1.2.8.8.12.5.1		Reference to node 1.1.1	4021
1.2.8.8.12.6	Number of Calcifications	6	4010
1.2.8.8.12.7	Single Image Finding	Individual Calcification	4006
1.2.8.8.12.7.1	Rendering Intent	Presentation Optional	4006
1.2.8.8.12.7.2	Algorithm Name	"Calc Detector"	4019
1.2.8.8.12.7.3	Algorithm Version	"V2.4"	4019
1.2.8.8.12.7.4	Center	POINT	4021
1.2.8.8.12.7.4.1		Reference to node 1.1.1	4021
1.2.8.8.12.7.5	Outline	SCOORD	4021
1.2.8.8.12.7.5.1		Reference to node 1.1.1	4021

Node	Code Meaning of Concept Name	Code Meaning or Example Value	TID
1.2.8.8.12.8	Single Image Finding	Individual Calcification	4006
1.2.8.8.12.8.1	Rendering Intent	Presentation Optional	4006
1.2.8.8.12.8.2	Algorithm Name	"Calc Detector"	4019
1.2.8.8.12.8.3	Algorithm Version	"V2.4"	4019
1.2.8.8.12.8.4	Center	POINT	4021
1.2.8.8.12.8.4.1		Reference to node 1.1.1	4021
1.2.8.8.12.8.5	Outline	SCOORD	4021
1.2.8.8.12.8.5.1		Reference to node 1.1.1	4021
1.2.8.8.12.9	Single Image Finding	Individual Calcification	4006
1.2.8.8.12.9.1	Rendering Intent	Presentation Optional	4006
1.2.8.8.12.9.2	Algorithm Name	"Calc Detector"	4019
1.2.8.8.12.9.3	Algorithm Version	"V2.4"	4019
1.2.8.8.12.9.4	Center	POINT	4021
1.2.8.8.12.9.4.1		Reference to node 1.1.1	4021
1.2.8.8.12.9.5	Outline	SCOORD	4021
1.2.8.8.12.9.5.1		Reference to node 1.1.1	4021
1.2.8.8.12.10	Single Image Finding	Individual Calcification	4006
1.2.8.8.12.10.1	Rendering Intent	Presentation Optional	4006
1.2.8.8.12.10.2	Algorithm Name	"Calc Detector"	4019
1.2.8.8.12.10.3	Algorithm Version	"V2.4"	4019
1.2.8.8.12.10.4	Center	POINT	4021
1.2.8.8.12.10.4.1		Reference to node 1.1.1	4021
1.2.8.8.12.10.5	Outline	SCOORD	4021
1.2.8.8.12.10.5.1		Reference to node 1.1.1	4021
1.2.8.8.12.11	Single Image Finding	Individual Calcification	4006
1.2.8.8.12.11.1	Rendering Intent	Presentation Optional	4006
1.2.8.8.12.11.2	Algorithm Name	"Calc Detector"	4019
1.2.8.8.12.11.3	Algorithm Version	"V2.4"	4019
1.2.8.8.12.11.4	Center	POINT	4021
1.2.8.8.12.11.4.1		Reference to node 1.1.1	4021
1.2.8.8.12.11.5	Outline	SCOORD	4021
1.2.8.8.12.11.5.1		Reference to node 1.1.1	4021

Node	Code Meaning of Concept Name	Code Meaning or Example Value	TID
1.2.8.8.12.12	Single Image Finding	Individual Calcification	4006
1.2.8.8.12.12.1	Rendering Intent	Presentation Optional	4006
1.2.8.8.12.12.2	Algorithm Name	"Calc Detector"	4019
1.2.8.8.12.12.3	Algorithm Version	"V2.4"	4019
1.2.8.8.12.12.4	Center	POINT	4021
1.2.8.8.12.12.4.1		Reference to node 1.1.1	4021
1.2.8.8.12.12.5	Outline	SCOORD	4021
1.2.8.8.12.12.5.1		Reference to node 1.1.1	4021

Included content from prior mammography CAD report (see Example 2, starting with node 1.2.4.2)

Node	Code Meaning of Concept Name	Code Meaning or Example Value	TID
1.2.8.8.13	Single Image Finding	Calcification Cluster	4006
1.2.8.8.13.1	Rendering Intent	Presentation Required	4006
1.2.8.8.13.2	Algorithm Name	"Calc Clustering"	4019
1.2.8.8.13.3	Algorithm Version	"V2.4"	4019
1.2.8.8.13.4	Center	POINT	4021
1.2.8.8.13.4.1		Reference to node 1.1.5	4021
1.2.8.8.13.5	Outline	SCOORD	4021
1.2.8.8.13.5.1		Reference to node 1.1.5	4021
1.2.8.8.13.6	Number of Calcifications	2	4010
1.2.8.8.13.7	[Observation Context content items]		4022
1.2.8.8.13.8	Single Image Finding	Individual Calcification	4006
1.2.8.8.13.8.1	Rendering Intent	Presentation Optional	4006
1.2.8.8.13.8.2	Algorithm Name	"Calc Detector"	4019
1.2.8.8.13.8.3	Algorithm Version	"V2.4"	4019
1.2.8.8.13.8.4	Center	POINT	4021
1.2.8.8.13.8.4.1		Reference to node 1.1.5	4021
1.2.8.8.13.8.5	Outline	SCOORD	4021
1.2.8.8.13.8.5.1		Reference to node 1.1.5	4021
1.2.8.8.13.9	Single Image Finding	Individual Calcification	4006
1.2.8.8.13.9.1	Rendering Intent	Presentation Optional	4006
1.2.8.8.13.9.2	Algorithm Name	"Calc Detector"	4019
1.2.8.8.13.9.3	Algorithm Version	"V2.4"	4019

Node	Code Meaning of Concept Name	Code Meaning or Example Value	TID
1.2.8.8.13.9.4	Center	POINT	4021
1.2.8.8.13.9.4.1		Reference to node 1.1.5	4021
1.2.8.8.13.9.4	Outline	SCoord	4021
1.2.8.8.13.9.4.1		Reference to node 1.1.5	4021

More current year content:

Node	Code Meaning of Concept Name	Code Meaning or Example Value	TID
1.3	Summary of Detections	Succeeded	4000
1.3.1	Successful Detections		4015
1.3.1.1	Detection Performed	Density	4017
1.3.1.1.1	Algorithm Name	"Density Detector"	4019
1.3.1.1.2	Algorithm Version	"V3.7"	4019
1.3.1.1.3		Reference to node 1.1.1	4017
1.3.1.1.4		Reference to node 1.1.2	4017
1.3.1.1.5		Reference to node 1.1.3	4017
1.3.1.1.6		Reference to node 1.1.4	4017
1.3.1.2	Detection Performed	Individual Calcification	4017
1.3.1.2.1	Algorithm Name	"Calc Detector"	4019
1.3.1.2.2	Algorithm Version	"V2.4"	4019
1.3.1.2.3		Reference to node 1.1.1	4017
1.3.1.2.4		Reference to node 1.1.2	4017
1.3.1.2.5		Reference to node 1.1.3	4017
1.3.1.2.6		Reference to node 1.1.4	4017
1.3.1.3	Detection Performed	Calcification Cluster	4017
1.3.1.3.1	Algorithm Name	"Calc Clustering"	4019
1.3.1.3.2	Algorithm Version	"V2.4"	4019
1.3.1.3.3		Reference to node 1.1.1	4017
1.3.1.4	Detection Performed	Calcification Cluster	4017
1.3.1.4.1	Algorithm Name	"Calc Cluster Detector"	4019
1.3.1.4.2	Algorithm Version	"V2.4"	4019
1.3.1.4.3		Reference to node 1.1.1	4017
1.3.1.4.4		Reference to node 1.1.2	4017

Node	Code Meaning of Concept Name	Code Meaning or Example Value	TID
1.3.1.4.5		Reference to node 1.1.3	4017
1.3.1.4.6		Reference to node 1.1.4	4017
1.4	Summary of Analyses	Succeeded	4000
1.4.1	Successful Analyses		4016
1.4.1.1	Analysis Performed	Mass Correlation	4018
1.4.1.1.1	Algorithm Name	"Mass Maker"	4019
1.4.1.1.2	Algorithm Version	"V1.9"	4019
1.4.1.1.3		Reference to node 1.1.2	4018
1.4.1.1.4		Reference to node 1.1.4	4018
1.4.1.2	Analysis Performed	Temporal Correlation	4018
1.4.1.2.1	Algorithm Name	"Temporal Change"	4019
1.4.1.2.2	Algorithm Version	"V0.1"	4019
1.4.1.2.3		Reference to node 1.1.2	4018
1.4.1.2.4		Reference to node 1.1.4	4018
1.4.1.2.5		Reference to node 1.1.6	4018
1.4.1.2.6		Reference to node 1.1.8	4018
1.4.1.3	Analysis Performed	Individual Impression / Recommendation Analysis	4018
1.4.1.3.1	Algorithm Name	"Lesion Analyzer"	4019
1.4.1.3.2	Algorithm Version	"V1.0"	4019
1.4.1.3.3		Reference to node 1.1.2	4018
1.4.1.3.4		Reference to node 1.1.4	4018
1.4.1.3.5		Reference to node 1.1.6	4018
1.4.1.3.6		Reference to node 1.1.8	4018
1.4.1.4	Analysis Performed	Overall Impression / Recommendation Analysis	4018
1.4.1.4.1	Algorithm Name	"Mammogram Analyzer"	4019
1.4.1.4.2	Algorithm Version	"V1.0"	4019
1.4.1.4.3		Reference to node 1.1.2	4018
1.4.1.4.4		Reference to node 1.1.4	4018

Node	Code Meaning of Concept Name	Code Meaning or Example Value	TID
1.4.1.4.5		Reference to node 1.1.6	4018
1.4.1.4.6		Reference to node 1.1.8	4018

Annex M Index

(0004,1130)		591
(0004,1141)		591
(0004,1142)		591
(0004,1200)		592
(0004,1202)		592
(0004,1212)		592
(0004,1220)		592, 593, 594
(0004,1400)		592, 593
(0004,1410)		593, 613
(0004,1420)		593
(0004,1430)		594, 595
(0004,1432)		594
(0004,1500)		594, 595
(0004,1504)		595
(0004,1510)		595, 613
(0004,1511)	592, 595, 600, 601, 602, 603, 604, 605, 606, 607, 608, 609, 610, 611, 612	
(0004,1512)		595
(0004,1600)		613
(0008,0001)		504
(0008,0005)	460, 496, 498, 499, 500, 501, 552, 599, 600, 601, 602, 603, 604, 605, 606, 607, 608, 609, 610, 611, 612	
(0008,0008)	27, 160, 163, 164, 202, 203, 205, 208, 214, 215, 216, 217, 218, 219, 220, 221, 222, 228, 230, 231, 233, 234, 246, 251, 265, 266, 289, 291, 386, 389, 398, 404, 409, 438, 439, 471	
(0008,0012)		468, 496, 604
(0008,0013)		468, 496
(0008,0014)		496
(0008,0016)		496
(0008,0018)		496, 534, 535, 536, 537
(0008,0020)		121, 149, 509, 600
(0008,0021)		122, 151, 375, 380, 381, 390, 392, 393
(0008,0022)		160, 387, 389, 390
(0008,0023)		160, 222, 468, 539, 548, 558, 610, 611, 612
(0008,0024)		444
(0008,0025)		449
(0008,002A)		156, 157, 160, 249, 468, 471, 625
(0008,0030)		121, 149, 509, 600
(0008,0031)		122, 151, 375, 380, 381, 384, 385, 389, 390, 392, 393
(0008,0032)		160, 225, 226, 381, 387, 389, 390
(0008,0033)		160, 173, 222, 438, 468, 471, 539, 548, 558, 610, 611, 612
(0008,0034)		444
(0008,0035)		449
(0008,0050)		119, 126, 127, 134, 140, 149, 509, 541, 558, 600
(0008,0054)		122, 130, 194, 493, 525, 528, 534, 542
(0008,0060)	81, 82, 84, 85, 86, 88, 121, 123, 124, 130, 151, 153, 154, 249, 258, 259, 286, 288, 395, 397, 428, 432, 440, 441, 492, 537, 557, 600, 606	
(0008,0064)		258, 259, 262, 289
(0008,0068)		61, 63, 66, 398, 399, 407

(0008,0070)	158, 324, 340, 351, 520, 532
(0008,0080)	116, 158, 324, 340, 351, 604
(0008,0081)	116, 158, 324, 340, 351
(0008,0082)	116
(0008,0090)	117, 126, 135, 149, 509
(0008,0092)	117
(0008,0094)	117
(0008,0100)	1, 2, 3, 4, 5, 6, 136, 184, 188, 402, 404, 421, 422, 423, 424, 425, 426, 428, 430, 431, 433, 434, 435, 437, 564, 567, 605, 606
(0008,0102)	1, 2, 3, 4, 6, 211, 224, 402, 421, 423, 424, 425, 430, 431, 433, 434, 564, 568, 605, 606
(0008,0103)	2, 3, 4, 6, 564, 568
	3, 4, 5, 6, 211, 221, 222, 224, 225, 229, 402, 404, 422, 423, 424, 425, 426, 428, 430, 431, 433, 434, 435, 437, 564, 568, 605, 606
(0008,0105)	4, 5, 6, 566, 567, 568
(0008,0106)	5, 6, 566, 567, 568
(0008,0107)	5, 6, 566, 568
(0008,010B)	5, 6, 566, 568
(0008,010C)	2, 3, 6, 566, 567
(0008,010D)	5, 6, 566, 568
(0008,010E)	5
	2, 5, 6, 566, 567, 568
(0008,0201)	497
(0008,1010)	158
(0008,1030)	123, 149, 509, 600, 606
(0008,1032)	123, 129, 149, 606
(0008,103E)	130, 151, 286
(0008,1040)	158, 324, 341, 351
(0008,1048)	149
(0008,1050)	123, 130, 151, 606
(0008,1060)	121, 149, 509
(0008,1070)	130, 151, 288, 311, 352, 363, 371
(0008,1080)	117, 150, 509
(0008,1084)	117, 150
(0008,1090)	158, 325, 341, 351, 520, 532
(0008,1100)	119, 144
(0008,1110)	112, 116, 123, 125, 127, 134, 140, 143, 149, 540, 558
(0008,1111)	119, 137, 151, 153, 286, 398, 528, 538, 557
(0008,1115)	122, 193, 194, 195, 493, 542, 610
(0008,1120)	116, 119, 127, 147
(0008,1125)	112, 119
(0008,1130)	221, 246, 247, 388, 449
(0008,113A)	247
(0008,1140)	122, 130, 155, 160, 161, 194, 266, 267, 439, 440, 444, 449, 451, 453, 454, 456, 459, 483, 491, 494, 534, 542, 610
(0008,1199)	560
(0008,1145)	221, 247, 388, 449
(0008,114A)	468
(0008,1150)	112, 116, 119, 122, 123, 125, 127, 130, 131, 134, 137, 139, 140, 141, 143, 144, 147, 149, 151, 160, 161, 164, 194, 221, 246, 247, 267, 286, 290, 298, 300, 303, 304, 306, 312, 319, 326, 328, 342, 350, 353, 365, 388, 398, 439, 444, 449, 451, 454, 456, 459, 468, 469, 483, 491, 494, 508, 515, 518, 525, 528, 531, 532, 534, 536, 538, 540, 542, 557, 558, 560, 610
(0008,1155)	112, 116, 119, 122, 123, 125, 127, 130, 131, 134, 137, 139, 140, 141, 143, 144, 147, 149, 151, 161, 194, 221, 247, 267, 286, 290, 298, 300, 303, 304, 306, 312, 320, 326, 328, 342, 350, 354, 365, 388, 398, 439,

444, 449, 451, 453, 454, 456, 459, 468, 469, 483, 491, 494, 508, 515, 518, 525, 528, 531, 533, 534, 535,
536, 538, 540, 542, 557, 558, 560, 561, 610

(0008,115A)		525
(0008,1160)	160, 161, 291, 295, 304, 306, 456, 459, 491, 494, 518, 534, 536, 560	
(0008,1195)		141, 528
(0008,1197)		528
(0008,1198)		528
(0008,1199)		528, 560
(0008,2111)	161, 162, 163, 164, 267, 268, 406, 409	
(0008,2112)	161, 163, 164, 259, 279, 399, 408	
(0008,2120)		247
(0008,2122)		247
(0008,2124)		246
(0008,2127)		247
(0008,2128)		248
(0008,2129)		248
(0008,212A)		246
(0008,2130)		248
(0008,2132)		248
(0008,2142)		173
(0008,2143)		173
(0008,2144)		173
(0008,2200)		256
(0008,2204)		256
(0008,2208)		223, 256, 269
(0008,2218)	152, 221, 223, 248, 256, 266, 269, 388, 400, 401, 402, 422, 423, 424, 425, 426, 429, 430, 431, 432, 433	
(0008,2220)	221, 223, 248, 256, 266, 269, 389, 401, 402, 433	
(0008,2228)	1, 222, 223, 248, 256, 266, 269, 389, 401, 404, 432, 434, 437	
(0008,2229)		131
(0008,2230)	222, 223, 248, 256, 266, 269, 389, 400, 401, 404	
(0008,2240)		248
(0008,2242)		248
(0008,2244)		248
(0008,2246)		249
(0010,0010)	113, 127, 134, 140, 147, 193, 509, 599	
(0010,0020)	113, 127, 134, 140, 147, 193, 509, 518, 525, 534, 599	
(0010,0021)		113
(0010,0030)	114, 127, 134, 140, 147, 509	
(0010,0032)		114, 147, 509
(0010,0040)	114, 127, 134, 140, 147, 509	
		1, 114
(0010,1000)		113, 147, 509
(0010,1001)		113, 147, 509
(0010,1005)		113
(0010,1010)		114, 150, 509
(0010,1020)		114, 150, 509
(0010,1030)		114, 150, 509
(0010,1040)		114
(0010,1060)		113
(0010,1080)		114
(0010,1081)		114
(0010,1090)		113
(0010,2000)		115
(0010,2110)		115

(0010,2150)	114
(0010,2152)	114
(0010,2154)	114
(0010,2160)	114, 147, 509
(0010,2180)	114, 150, 509
(0010,21A0)	115
(0010,21B0)	115, 150, 509
(0010,21C0)	115
(0010,21D0)	115
(0010,21F0)	115
(0010,4000)	115, 147, 509
(0018,0010)	171
(0018,0012)	171
(0018,0014)	171
(0018,0015)	152, 199, 223, 256, 269, 401, 402
(0018,0020)	205, 206
(0018,0021)	205, 206
(0018,0022)	46, 202, 206, 266
(0018,0023)	206
(0018,0024)	206
(0018,0025)	207
(0018,0026)	225, 385
(0018,0027)	185, 225, 385
(0018,0028)	225, 385
(0018,0029)	1, 184, 225, 385
(0018,002A)	171
(0018,0031)	225, 384
(0018,0034)	385
(0018,0035)	185, 225, 385
(0018,0036)	184, 185
(0018,0038)	184
(0018,0039)	185
(0018,0040)	173
(0018,0050)	165, 235
	422, 423, 424, 425
(0018,0060)	132, 200, 202, 269, 279, 283, 291
(0018,0070)	219, 222
(0018,0071)	219, 223, 377
(0018,0072)	173
(0018,0073)	377, 381
(0018,0074)	377
(0018,0075)	377
(0018,0080)	206
(0018,0081)	206
(0018,0082)	206
(0018,0083)	207
(0018,0084)	207
(0018,0085)	207
(0018,0086)	207
(0018,0087)	207
(0018,0088)	207, 235
(0018,0089)	207
(0018,0091)	206
(0018,0093)	207

(0018,0094)	207
(0018,0095)	207
(0018,1000)	158, 325, 341, 351, 520, 532
(0018,1004)	200, 201
(0018,1010)	258
(0018,1011)	395
(0018,1012)	259
(0018,1014)	259
(0018,1016)	258
(0018,1017)	395
(0018,1018)	258
(0018,1019)	258
(0018,101A)	395
(0018,101B)	395
(0018,1020)	158, 520, 532
(0018,1022)	258
(0018,1023)	258
(0018,1030)	130, 151
(0018,1040)	171
(0018,1041)	171
(0018,1042)	171
(0018,1043)	172
(0018,1044)	172
(0018,1045)	225, 226
(0018,1046)	172
(0018,1047)	172
(0018,1048)	172
(0018,1049)	172
(0018,1050)	158
(0018,1060)	206, 232, 249, 386, 391
(0018,1061)	156, 221, 385
(0018,1062)	207, 232, 249, 387
(0018,1063)	33, 34, 36, 37, 172, 173, 232, 233, 252, 265, 386, 389
(0018,1064)	232, 385, 389
(0018,1065)	33, 34, 36, 37, 172, 173, 252, 263, 265
(0018,1066)	173
(0018,1067)	173
(0018,1068)	468, 471, 625
(0018,1069)	468
(0018,106A)	156
(0018,106C)	156, 157
(0018,106E)	469, 471
(0018,1070)	224, 384
(0018,1071)	224, 384
(0018,1072)	224, 226, 381, 384
(0018,1073)	225, 226, 384
(0018,1074)	225, 226, 384
(0018,1075)	381, 384, 390
(0018,1076)	384
(0018,1077)	384
(0018,1080)	207, 232, 249, 385, 386, 387
(0018,1081)	207, 217, 232, 233, 249, 381, 386, 387, 391
(0018,1082)	207, 217, 232, 233, 249, 381, 387
(0018,1083)	207, 233, 387

(0018,1084)	207, 233, 387
(0018,1085)	207, 232, 385
(0018,1086)	207, 232, 385
(0018,1088)	207, 208, 232, 249, 385
(0018,1090)	207
(0018,1094)	208
(0018,1100)	202, 208, 235, 377
(0018,1110)	131, 133, 200, 203, 228, 231, 274, 278, 280, 419
(0018,1111)	200, 203, 274, 278, 280, 419
(0018,1114)	274, 278, 419
(0018,1120)	203, 228, 229, 378, 382
(0018,1121)	378
(0018,1130)	203, 219, 231
(0018,1131)	220, 230, 231
(0018,1134)	273
(0018,1135)	273
(0018,1136)	273
(0018,1137)	273
(0018,1138)	273, 421
(0018,113A)	421
(0018,1140)	203, 230
(0018,1142)	228, 231
(0018,1143)	230
(0018,1144)	230, 231
(0018,1145)	228, 229
(0018,1147)	227, 270, 378, 412, 413, 414
(0018,1149)	227, 270, 271, 378, 412, 414
(0018,1150)	133, 200, 203, 269, 270, 279, 283, 291, 411
(0018,1151)	200, 203, 269, 270, 279, 283, 291
(0018,1152)	200, 203, 269, 270, 279, 283
(0018,1153)	200, 203, 270, 280, 283
(0018,1154)	270
(0018,1155)	269
(0018,1156)	283, 284
(0018,115A)	132, 270
(0018,115E)	132, 270, 280
(0018,1160)	133, 199, 203, 284
(0018,1161)	270
(0018,1162)	270
(0018,1164)	200, 270, 413, 414, 457
(0018,1166)	270, 285
(0018,1170)	200, 203
(0018,1180)	199, 227, 378
(0018,1181)	227, 378
(0018,1182)	227, 229
(0018,1183)	227, 229
(0018,1184)	227, 229
(0018,1190)	199, 203, 270, 283
(0018,1191)	282, 284
(0018,11A0)	280, 421
(0018,11A2)	421
(0018,1200)	158, 159, 520, 532
(0018,1201)	158, 159, 520, 532
(0018,1210)	203, 235, 377

(0018,1242)	173, 220, 223, 231, 234, 387, 390
(0018,1243)	220
(0018,1244)	172
(0018,1250)	208
(0018,1251)	208
(0018,1260)	200
(0018,1261)	200
(0018,1300)	221
(0018,1301)	220
(0018,1302)	221
(0018,1310)	208
(0018,1312)	208
(0018,1314)	208
(0018,1315)	208
(0018,1316)	208
(0018,1318)	208
(0018,1400)	200, 267, 268, 406, 408, 409
(0018,1401)	200, 406
(0018,1402)	201
(0018,1403)	201
(0018,1404)	201
(0018,1405)	201, 281
(0018,1450)	278, 421
(0018,1460)	279
(0018,1470)	279
(0018,1480)	279
(0018,1491)	279
(0018,1495)	279
(0018,1500)	275, 425
(0018,1508)	420, 421, 428, 432
(0018,1510)	275, 276, 420, 428
(0018,1511)	275, 276, 420, 428
(0018,1520)	275
(0018,1521)	275
(0018,1530)	275, 420
(0018,1531)	275, 421
(0018,1600)	178, 179, 193
(0018,1602)	178
(0018,1604)	178
(0018,1606)	178
(0018,1608)	178
(0018,1610)	178
(0018,1612)	178
(0018,1620)	179
(0018,1622)	178, 179, 192, 193, 494
(0018,1623)	193
(0018,1700)	271, 272
(0018,1702)	272, 273
(0018,1704)	272, 273
(0018,1706)	272, 273
(0018,1708)	272, 273
(0018,1710)	272
(0018,1712)	272
(0018,1720)	272

(0018,1800)	156, 157, 160, 249, 468
(0018,1801)	156, 157
(0018,1802)	156, 157
(0018,2001)	263
(0018,2002)	263
(0018,2003)	263
(0018,2004)	263
(0018,2005)	263
(0018,2006)	264
(0018,2010)	262
(0018,2020)	262
(0018,2030)	262
(0018,3100)	249, 250, 257
(0018,3101)	249, 256, 257
(0018,3102)	249, 257
(0018,3103)	250, 256, 257
(0018,3104)	250, 256, 257
(0018,3105)	250
(0018,5000)	250
(0018,5010)	250
(0018,5012)	250
(0018,5020)	220, 250, 392
(0018,5022)	250
(0018,5024)	250
(0018,5026)	250
(0018,5027)	251
(0018,5028)	251
(0018,5029)	251
(0018,5050)	251
(0018,5100)	152, 154, 199, 223, 256, 269, 317, 418, 424, 425
(0018,5101)	199, 418, 421
(0018,5104)	418
(0018,5210)	251, 253
(0018,5212)	251, 253
(0018,6000)	201, 412
(0018,6011)	238
(0018,6012)	239, 242
(0018,6014)	239, 242
(0018,6016)	239, 242, 244
(0018,6018)	236, 237, 238
(0018,601A)	236, 237, 238
(0018,601C)	236, 237, 238
(0018,601E)	236, 237, 238
(0018,6020)	237, 239
(0018,6022)	237, 239
(0018,6024)	236, 237, 238
(0018,6026)	236, 237, 238
(0018,6028)	237, 239
(0018,602A)	237, 239
(0018,602C)	236, 239
(0018,602E)	236, 239
(0018,6030)	241
(0018,6031)	250
(0018,6032)	241

(0018,6034)	241
(0018,6036)	241
(0018,6038)	241
(0018,603A)	241
(0018,603C)	241, 244
(0018,603E)	242, 244
(0018,6040)	242, 244
(0018,6042)	242, 244
(0018,6044)	243, 244
(0018,6046)	239, 243
(0018,6048)	240, 244
(0018,604A)	240
(0018,604C)	240, 243, 244, 245
(0018,604E)	240, 244
(0018,6050)	240, 244
(0018,6052)	240, 244
(0018,6054)	240, 244
(0018,6056)	245
(0018,6058)	241, 245
(0018,605A)	241, 245
(0018,7000)	411
(0018,7001)	411
(0018,7004)	410
(0018,7005)	410
(0018,7006)	410
(0018,7008)	410
(0018,700A)	410, 411
(0018,700C)	410
(0018,700E)	411
(0018,7010)	411
(0018,7011)	411
(0018,7012)	411
(0018,7014)	411
(0018,7016)	411
(0018,701A)	411, 415
(0018,7020)	413, 415
(0018,7022)	413, 415
(0018,7024)	413, 414, 415
(0018,7026)	414, 415
(0018,7028)	414, 415
(0018,7030)	412, 414
(0018,7032)	412, 413, 414
(0018,7034)	412, 413, 415
(0018,7040)	285
(0018,7041)	285
(0018,7042)	285
(0018,7044)	285
(0018,7046)	285
(0018,7048)	285
(0018,704C)	285
(0018,7050)	133, 162, 282, 284
(0018,7052)	282, 284
(0018,7054)	282, 284
(0018,7060)	283

(0018,7062)		283
(0018,7064)		283
(0018,7065)		283
(0018,8151)		133
(0018.1067)		157
(0020,000D)	119, 122, 125, 127, 134, 138, 140, 149, 193, 509, 518, 525, 534, 540, 542, 558, 600	
(0020,000E)	122, 130, 151, 193, 194, 286, 303, 456, 459, 491, 493, 494, 518, 525, 534, 537, 542, 557, 600, 610	
(0020,0010)		119, 122, 130, 149, 193, 509, 600
(0020,0011)		151, 286, 509, 537, 557, 600
(0020,0012)		160, 202
(0020,0013)	160, 259, 297, 302, 311, 350, 468, 493, 497, 518, 533, 539, 558, 601, 607, 608, 609, 610, 611, 612	
(0020,0019)		526
(0020,0020)		61, 160, 162, 406, 423
(0020,0022)		444, 601
(0020,0024)		449, 603
(0020,0026)		483, 602
(0020,0032)		160, 165, 228
(0020,0037)		160, 165, 228, 235, 379, 380, 391
(0020,0052)		155, 303, 304, 305
(0020,0060)		151, 400
(0020,0062)		151, 400, 429, 432
(0020,0100)		208
(0020,0105)		208
(0020,0110)		208
(0020,0200)		156
(0020,1000)		121
(0020,1002)		161
(0020,1004)		121
(0020,1040)		155
(0020,1041)		165, 235, 263
(0020,1070)		119
(0020,4000)		161
(0028, 3010)		407
(0028,0002)	33, 35, 36, 38, 166, 167, 168, 169, 202, 203, 205, 209, 212, 245, 254, 265, 288, 296, 300, 386, 395, 396, 404, 438, 439, 516, 517, 614	
(0028,0004)	28, 30, 33, 35, 36, 38, 159, 162, 166, 167, 168, 171, 195, 196, 200, 202, 204, 205, 209, 212, 245, 252, 260, 261, 265, 288, 296, 297, 300, 379, 386, 389, 395, 396, 404, 406, 409, 438, 439, 481, 482, 515, 516, 517, 614	
(0028,0006)		33, 35, 37, 38, 166, 169, 170, 246, 255, 396, 438, 439, 517, 614
(0028,0008)		174, 278
(0028,0009)	33, 34, 36, 37, 172, 174, 213, 214, 215, 216, 232, 233, 234, 246, 252, 261, 262, 263, 264, 265, 296, 299	
(0028,0010)		166, 167, 192, 273, 379, 395, 396, 414, 516, 517, 526
(0028,0011)		166, 167, 192, 273, 379, 395, 396, 414, 448, 516, 517, 526
(0028,0014)		246
(0028,0030)		165, 212, 229, 379, 457
(0028,0031)		228, 229
(0028,0032)		228, 229
(0028,0034)		166, 167, 262, 395, 396, 516, 517, 614
(0028,0051)		220, 376, 390
(0028,0100)	33, 35, 36, 38, 166, 167, 168, 169, 202, 204, 205, 209, 212, 245, 254, 265, 268, 288, 296, 297, 300, 379, 386, 395, 396, 404, 438, 439, 445, 516, 517, 614	
(0028,0101)	33, 35, 36, 38, 166, 167, 202, 204, 212, 245, 255, 260, 261, 265, 268, 288, 296, 297, 300, 379, 386, 396, 404, 438, 439, 517, 614	

(0028,0102)	33, 35, 36, 38, 166, 167, 202, 204, 212, 245, 255, 265, 268, 288, 296, 297, 300, 386, 396, 404, 438, 439, 490, 517, 614	
(0028,0103)	33, 35, 36, 38, 158, 166, 167, 170, 246, 252, 288, 296, 297, 300, 379, 396, 404, 438, 439, 479, 480, 481, 485, 490, 517, 614	
(0028,0106)		166
(0028,0107)		166
(0028,0108)		152
(0028,0109)		152
(0028,0120)		158, 159
(0028,0300)		161
(0028,0301)		161, 260, 407
(0028,1040)	44, 46, 159, 265, 268, 405, 408, 409	
(0028,1041)		159, 405, 408, 409
(0028,1050)	12, 260, 407, 409, 480, 481, 482, 491, 492	
(0028,1051)		12, 407, 409, 480, 481, 482, 492
(0028,1052)	12, 202, 261, 386, 405, 408, 409, 478	
(0028,1053)		202, 261, 386, 405, 408, 409, 478
(0028,1054)		261, 405, 478
(0028,1055)		408, 480, 492
(0028,1090)		177, 495
(0028,1101)		167, 195
(0028,1101-1103)		170, 196
(0028,1102)		167, 195
(0028,1103)		167, 195
(0028,1199)		195
(0028,1201)		167, 195
(0028,1201-1203)		170, 195
(0028,1202)		167, 195
(0028,1203)		167, 195, 196
(0028,1221)		196
(0028,1221-1223)		170, 195, 196
(0028,1222)		196
(0028,1223)		196
(0028,1300)		429
(0028,1350)		429
(0028,1351)		429
(0028,2110)	162, 164, 219, 246, 265, 387, 406, 438	
(0028,2112)		162, 406
(0028,3000)		12, 478
(0028,3002)	407, 410, 478, 479, 480, 481, 484, 487, 488, 491, 537	
(0028,3003)		407, 478, 480, 484, 487, 491, 537
(0028,3004)		478
(0028,3006)	407, 410, 478, 479, 480, 484, 487, 488, 492, 537	
(0028,3010)		12, 260, 407, 409, 480, 483, 491, 492
(0028,3110)		491
(0028,6010)		175
(0028,6020)		175
(0028,6022)		175
(0028,6040)		266
(0028,6100)		176, 494, 495
(0028,6101)		176, 177, 494, 495
(0028,6102)		176, 177, 494
(0028,6110)		176, 177, 495
(0028,6112)		176, 177, 495

(0028,6114)	176, 177
(0028,6120)	176, 177
(0028,6190)	177
(0032,000A)	120
(0032,000C)	120
(0032,0012)	119
(0032,0032)	121
(0032,0033)	121
(0032,0034)	121
(0032,0035)	121
(0032,1000)	120
(0032,1001)	120
(0032,1010)	120
(0032,1011)	120
(0032,1020)	120
(0032,1021)	120
(0032,1030)	120
(0032,1032)	120, 126, 135
(0032,1033)	120, 126, 135
(0032,1040)	121
(0032,1041)	121
(0032,1050)	121
(0032,1051)	121
(0032,1055)	123
(0032,1060)	120, 125, 127, 135, 140, 541, 558
(0032,1064)	120, 125, 134, 140, 541, 558
(0032,1070)	120, 125
(0032,4000)	120
(0038,0004)	112
(0038,0008)	117
(0038,0010)	116, 604
(0038,0011)	116
(0038,0016)	117
(0038,001A)	118
(0038,001B)	118
(0038,001C)	118
(0038,001D)	118
(0038,001E)	118
(0038,0020)	117, 604
(0038,0021)	117
(0038,0030)	118
(0038,0032)	118
(0038,0040)	118
(0038,0044)	118
(0038,0050)	115
(0038,0300)	117
(0038,0400)	117
(0038,0500)	115
(0038,4000)	117
(003A,0003)	471
(003A,0004)	86, 88, 469
(003A,0005)	81, 82, 84, 85, 86, 469, 625
(003A,0010)	83, 469, 625
(003A,001A)	81, 83, 84, 85, 86, 88, 469, 624

(003A,0020)	469
(003A,0200)	157, 469, 476, 561, 624
(003A,0202)	469, 624
(003A,0203)	469, 624
(003A,0205)	469, 624
(003A,0208)	83, 84, 85, 86, 88, 469, 471, 624, 626
(003A,0209)	87, 88, 469, 471, 624
(003A,020A)	469
(003A,020C)	470
(003A,0210)	470, 472, 624
(003A,0211)	470, 624
(003A,0212)	470, 472, 624
(003A,0213)	470, 624
(003A,0214)	470, 624
(003A,0215)	470
(003A,0218)	470, 624
(003A,021A)	470, 473, 474, 625
(003A,0220)	470, 624
(003A,0221)	470, 624
(003A,0222)	470, 624
(003A,0223)	470, 624
(003A,0231)	473
(003A,0241)	473
(003A,1000)	625
(0040,0301)	132
(0040,0001)	124
(0040,0002)	124, 137
(0040,0003)	124
(0040,0004)	124
(0040,0005)	124
(0040,0006)	124
(0040,0007)	124, 127, 152, 287
(0040,0008)	25, 124, 127, 152, 287
(0040,0009)	124, 127, 136, 152, 287
(0040,000A)	247
(0040,0010)	124
(0040,0011)	124
(0040,0012)	125
(0040,0100)	124
(0040,0220)	131
(0040,0241)	129
(0040,0242)	129
(0040,0243)	129
(0040,0244)	129, 142, 152, 153, 287
(0040,0245)	129, 142, 152, 153, 287
(0040,0250)	129, 142
(0040,0251)	129, 142
(0040,0252)	129
(0040,0253)	129, 142, 152, 287
(0040,0254)	129, 142, 152, 153, 287
(0040,0255)	129
(0040,0260)	130, 151, 153, 287
(0040,0270)	127
(0040,0275)	152, 287

(0040,0280)	129, 142
(0040,0293)	134
(0040,0294)	134
(0040,0295)	134
(0040,0296)	133
(0040,0300)	131
(0040,0301)	131
(0040,0302)	132, 281
(0040,0303)	132, 133, 281
(0040,0306)	132, 281
(0040,030E)	132
(0040,0310)	132, 281
(0040,0312)	281, 282
(0040,0314)	282
(0040,0316)	282, 429
(0040,0318)	282, 429
(0040,0320)	133
(0040,0321)	133
(0040,0324)	133
(0040,0340)	130
(0040,0400)	124, 137
(0040,050A)	148
(0040,0550)	148
(0040,0551)	148
(0040,0555)	82, 86, 88, 185, 186, 625
(0040,0556)	187
(0040,059A)	148
(0040,06CA)	148
(0040,06FA)	148
(0040,071A)	440
(0040,072A)	440
(0040,073A)	440, 443
(0040,074A)	440
(0040,08D8)	440
(0040,08DA)	440, 441
(0040,08EA)	185, 186, 187, 441, 475, 559
(0040,1001)	125, 127, 135, 140, 152, 287, 541, 558
(0040,1002)	125, 126, 135
(0040,1003)	125
(0040,1004)	125
(0040,1005)	125
(0040,1008)	125, 135
(0040,1009)	125
(0040,1010)	125, 135
(0040,1400)	125, 135
(0040,2001)	125, 126, 135
(0040,2004)	126, 135
(0040,2005)	126, 135
(0040,2006)	126, 128
(0040,2007)	126, 128
(0040,2008)	126
(0040,2009)	126
(0040,2010)	126
(0040,2016)	126, 127, 128, 135, 140, 541, 558

(0040,2017)	126, 127, 128, 135, 140, 541, 558
(0040,2400)	126, 135
(0040,3001)	114
(0040,4001)	136, 139
(0040,4002)	142
(0040,4003)	136
(0040,4004)	136
(0040,4006)	139
(0040,4007)	142
(0040,4009)	137, 139, 141
(0040,4011)	137
(0040,4015)	139
(0040,4016)	140
(0040,4018)	137
(0040,4019)	142
(0040,4020)	138
(0040,4021)	138
(0040,4022)	138
(0040,4023)	141
(0040,4025)	136
(0040,4026)	136
(0040,4027)	136
(0040,4028)	141
(0040,4029)	141
(0040,4030)	141
(0040,4031)	143
(0040,4032)	143
(0040,4033)	143
(0040,4034)	137
(0040,4035)	139, 141
(0040,4036)	137, 139, 141
(0040,4037)	137, 139, 141
(0040,A010)	549
(0040,A027)	539, 540
(0040,A030)	540, 611
(0040,A032)	548
(0040,A040)	547, 551, 552, 553
(0040,A043)	83, 84, 87, 89, 185, 186, 187, 188, 474, 475, 543, 544, 551, 553, 569, 611, 612
(0040,A050)	552, 553
(0040,A073)	539
(0040,A075)	539, 540
(0040,A088)	539
(0040,A0B0)	470, 475, 476, 561, 563
(0040,A120)	552
(0040,A121)	185, 186, 187, 552
(0040,A122)	185, 187, 552
(0040,A123)	185, 187, 552
(0040,A124)	552
(0040,A130)	475, 476, 563
(0040,A132)	475, 476, 563
(0040,A136)	186
(0040,A138)	475, 476, 563
(0040,A13A)	475, 476, 563
(0040,A160)	185, 187, 552

(0040,A168)	185, 187, 188, 475, 560
(0040,A170)	247
(0040,A180)	476
(0040,A195)	475
(0040,A300)	559
(0040,A30A)	185, 186, 187, 441, 475, 559, 569
(0040,A360)	540
(0040,A370)	134, 139, 140, 540, 558
(0040,A372)	541
(0040,A375)	538, 541, 558
(0040,A385)	541
(0040,A491)	539, 611
(0040,A492)	539
(0040,A493)	539, 611
(0040,A504)	548
(0040,A525)	540, 559
(0040,A730)	549, 550, 558
(0040,B020)	83, 84, 89, 474, 626
(0040,DB73)	550
(0050,0004)	267, 407
(0050,0010)	183, 184
(0050,0014)	183, 184
(0050,0016)	183, 184
(0050,0017)	183
(0050,0018)	184
(0050,0019)	184
(0050,0020)	184
(0054,0010)	213, 214, 216, 224
(0054,0011)	214, 216, 224
(0054,0012)	224
(0054,0013)	224, 378
(0054,0014)	224, 226, 379
(0054,0015)	224, 226, 379
(0054,0016)	224, 384
(0054,0017)	225, 226
(0054,0018)	224
(0054,0020)	213, 214, 216, 217, 227
(0054,0021)	214, 216, 217, 227
(0054,0022)	227
(0054,0030)	213, 214, 216, 217, 234
(0054,0031)	214, 217, 234
(0054,0032)	234
(0054,0033)	218, 234
(0054,0036)	234
(0054,0038)	234
(0054,0050)	214, 216, 217, 230
(0054,0051)	214, 217, 230
(0054,0052)	230
(0054,0053)	218, 231
(0054,0060)	214, 215, 216, 217, 232
(0054,0061)	215, 217, 232, 375, 391
(0054,0062)	232
(0054,0063)	232, 233
(0054,0070)	215, 216, 217, 233

(0054,0071)	215, 217, 233, 376, 391, 392
(0054,0072)	233
(0054,0073)	233
(0054,0080)	215, 216, 218
(0054,0081)	215, 217, 218, 376, 391, 392
(0054,0090)	215, 216, 218
(0054,0100)	213, 215, 216, 218
(0054,0101)	376, 391
(0054,0200)	228, 230
(0054,0202)	231, 378
(0054,0210)	234
(0054,0211)	234
(0054,0220)	229, 418, 421, 425, 429, 430, 433
(0054,0222)	229, 418, 429
(0054,0300)	224, 384
(0054,0302)	185, 224, 225, 384
(0054,0304)	225, 385
(0054,0306)	225
(0054,0308)	225
(0054,0400)	219
(0054,0410)	211, 419
(0054,0412)	211, 418, 419, 423
(0054,0414)	211, 212, 418, 419, 425
(0054,1000)	57, 58, 375, 376, 379, 380, 381, 386, 387, 389, 390, 391
(0054,1001)	375, 386
(0054,1002)	375
(0054,1004)	375, 381
(0054,1100)	376, 387
(0054,1101)	376
(0054,1102)	377, 381, 388, 393
(0054,1103)	377
(0054,1104)	377
(0054,1105)	376
(0054,1200)	378
(0054,1201)	378, 382
(0054,1202)	378, 382
(0054,1203)	378, 382
(0054,1210)	378
(0054,1220)	379, 390
(0054,1300)	381, 386, 390, 391
(0054,1310)	387
(0054,1311)	387, 390
(0054,1320)	388
(0054,1321)	381, 388
(0054,1322)	388, 390, 391
(0054,1323)	388
(0054,1324)	388
(0054,1330)	387, 391
(0054,1400)	392
(0054,1401)	392
(0060,3000)	485
(0060,3002)	485, 486
(0060,3004)	485, 486
(0060,3006)	485, 486

(0060,3008)	485, 486
(0060,3010)	485, 486
(0060,3020)	485
(0070,0001)	459
(0070,0002)	459, 467, 490
(0070,0003)	460, 461, 462
(0070,0004)	460, 461
(0070,0005)	462, 463
(0070,0006)	460, 461, 474
(0070,0008)	459, 462
(0070,0009)	459, 462
(0070,0010)	460, 461
(0070,0011)	460, 461
(0070,0012)	461
(0070,0014)	460, 461, 463
(0070,0015)	461, 463
(0070,0020)	462
(0070,0021)	462
(0070,0022)	462, 463, 562
(0070,0023)	462, 463, 562
(0070,0024)	462, 464
(0070,0041)	465, 466
(0070,0042)	465
(0070,0052)	456
(0070,0053)	456
(0070,005A)	456
(0070,0060)	467
(0070,0062)	466, 467
(0070,0066)	467
(0070,0067)	467
(0070,0068)	467
(0070,0080)	493, 609
(0070,0081)	493, 609
(0070,0082)	493, 609
(0070,0083)	493, 610
(0070,0084)	493, 610
(0070,0100)	454, 457, 458
(0070,0101)	454, 455, 457
(0070,0102)	455, 457
(0070,0103)	458
(0070,0104)	455
(0088,0130)	122, 194, 493, 528, 542
(0088,0140)	122, 194, 195, 494, 528, 542
(0088,0200)	561, 600, 601, 607, 613
(0088,0904)	603
(0088,0906)	603
(0088,0910)	603
(0088,0912)	603
(0100,0410)	498
(0100,0420)	498
(0100,0424)	498
(0100,0426)	498
(0400,0005)	502
(0400,0010)	502, 506

(0400,0015)	502
(0400,0020)	502
(0400,0100)	502
(0400,0105)	502
(0400,0110)	503
(0400,0115)	503, 506
(0400,0120)	503, 506, 507
(0400,0305)	503, 506, 507
(0400,0310)	503, 506 568
(2000,0010)	508, 524
(2000,001E)	525
(2000,0020)	508, 519, 524, 531
(2000,0030)	133, 508, 524, 526, 531
(2000,0040)	508, 524, 531
(2000,0050)	508, 524, 531
(2000,0060)	508, 524, 525
(2000,0061)	525
(2000,0062)	524
(2000,0063)	524
(2000,0065)	524
(2000,0067)	524
(2000,0069)	524
(2000,006A)	525
(2000,00A0)	525
(2000,00A1)	526
(2000,00A2)	526
(2000,00A4)	526
(2000,00A8)	526
(2000,0500)	508
(2000,0510)	525
(2010,0010)	510, 515, 518, 526, 533
(2010,0030)	510, 519, 533
(2010,0040)	510, 526, 533
(2010,0050)	133, 511, 526, 533
(2010,0052)	527
(2010,0054)	527
(2010,0060)	448, 511, 515, 516, 533, 534
(2010,0080)	511, 516, 533, 534
(2010,00A6)	527
(2010,00A7)	527
(2010,00A8)	527
(2010,00A9)	527
(2010,0100)	511, 533
(2010,0110)	511, 533
(2010,0120)	484, 511, 526, 533
(2010,0130)	511, 526, 533
(2010,0140)	512, 533
(2010,0150)	512, 516, 525, 527, 533, 534
(2010,0152)	527
(2010,0154)	527
(2010,015E)	260, 262, 512, 525, 533
(2010,0160)	260, 262, 512, 525, 533
(2010,0376)	527

(2010,0500)	515
(2010,0510)	515
(2010,0520)	515
(2010,1030)	484
(2020,0010)	515, 518, 534
(2020,0020)	515, 534
(2020,0030)	516, 527, 534
(2020,0040)	516, 527, 534
(2020,0050)	512, 527, 533
(2020,00A0)	527
(2020,00A2)	527
(2020,0110)	516
(2020,0111)	517
(2020,0130)	518, 535
(2030,0010)	519, 535
(2030,0020)	519, 535
(2040,0010)	536
(2040,0011)	536
(2040,0020)	447, 536
(2040,0060)	447, 536
(2040,0070)	448, 536
(2040,0072)	448, 536
(2040,0074)	448, 536
(2040,0080)	448, 536
(2040,0082)	448, 536
(2040,0090)	536
(2040,0100)	536
(2050,0010)	484, 487, 537
(2050,0020)	162, 260, 406, 408, 409, 484, 487, 537
(2050,0500)	515, 533, 535
(2100,0010)	531
(2100,0020)	519, 531
(2100,0030)	519, 520, 531
(2100,0040)	519, 531, 532
(2100,0050)	519, 531, 532
(2100,0070)	519, 531, 532
(2100,0140)	531, 532
(2100,0160)	508, 525, 531
(2100,0170)	133, 531
(2110,0010)	520
(2110,0020)	520
(2110,0030)	519, 520, 531, 532
(2120,0010)	530
(2120,0050)	531
(2120,0070)	531
(2130,0010)	532
(2130,0015)	532
(2130,0030)	525, 533, 534, 535
(2130,0040)	525, 533, 534
(2130,0050)	524, 535
(2130,0060)	524, 535, 536
(2130,0080)	524, 525, 533, 535, 537
(2130,00A0)	509
(2130,00C0)	518

(3002,0002)	288
(3002,0003)	288
(3002,0004)	288
(3002,000A)	289, 295
(3002,000C)	289, 327
(3002,000D)	289, 295
(3002,000E)	289, 295, 327, 337
(3002,0010)	289, 327
(3002,0011)	290, 295
(3002,0012)	290, 327
(3002,0020)	290
(3002,0022)	290, 295
(3002,0024)	290
(3002,0026)	49, 290, 295, 327
(3002,0028)	290
(3002,0029)	291
(3002,0030)	291, 293, 295
(3002,0032)	291, 326, 337
(3002,0034)	292
(3004, 0002)	352
(3004,0001)	301
(3004,0002)	297, 299, 300, 301, 308, 352, 354, 366
(3004,0004)	297, 301
(3004,0006)	297, 607
(3004,0008)	297, 299
(3004,000A)	298, 299, 607
(3004,000C)	299
(3004,000E)	299
(3004,0010)	308
(3004,0012)	308, 309
(3004,0040)	300
(3004,0042)	300, 301
(3004,0050)	300, 302
(3004,0052)	301
(3004,0054)	301
(3004,0056)	301
(3004,0058)	301, 302
(3004,0060)	301, 302
(3004,0062)	301, 302
(3004,0070)	302
(3004,0072)	302
(3004,0074)	302
(3004,00EE)	329
(3006,0002)	302, 608
(3006,0004)	302
(3006,0006)	302
(3006,0008)	302, 608
(3006,0009)	302, 608
(3006,0010)	302, 303, 304, 305
(3006,0012)	303
(3006,0014)	303, 304
(3006,0016)	304, 305, 306
(3006,0020)	301, 304, 306, 308, 309, 314, 330, 343, 345, 357
(3006,0022)	301, 304, 308, 314, 330, 343, 345, 357

(3006,0024)	304
(3006,0026)	304
(3006,0028)	304
(3006,002A)	306
(3006,002C)	304
(3006,0030)	309
(3006,0033)	309
(3006,0036)	304
(3006,0038)	304
(3006,0039)	306
(3006,0040)	306, 307
(3006,0042)	302, 307, 308
(3006,0044)	307, 308
(3006,0045)	307, 308
(3006,0046)	307
(3006,0048)	306
(3006,0049)	306
(3006,0050)	307, 308
(3006,0080)	309
(3006,0082)	309, 310
(3006,0084)	301, 306, 308, 309, 314, 330, 343, 345, 357
(3006,0085)	309, 311
(3006,0086)	310
(3006,0088)	309
(3006,00A0)	310
(3006,00A4)	310, 311
(3006,00A6)	310
(3006,00B0)	311
(3006,00B2)	311
(3006,00B4)	311
(3006,00C0)	303
(3006,00C2)	303
(3006,00C4)	303
(3006,00C6)	303
(3006,00C8)	303
(3008,0010)	351, 354, 365, 366, 369
(3008,0012)	352
(3008,0014)	352
(3008,0016)	352, 354, 366, 369
(3008,0020)	353
(3008,0022)	358, 366
(3008,0024)	359, 371
(3008,0025)	359, 371
(3008,002A)	358, 367, 373
(3008,002B)	358, 367
(3008,002C)	358, 367
(3008,0030)	350, 374
(3008,0032)	358
(3008,0033)	358
(3008,0036)	358
(3008,0037)	358
(3008,003A)	358
(3008,003B)	358
(3008,0040)	359, 360, 361, 362, 363

(3008,0042)	359
(3008,0044)	359
(3008,0048)	359
(3008,0050)	373
(3008,0052)	373
(3008,0054)	372
(3008,0056)	372
(3008,005A)	372
(3008,0060)	363, 371
(3008,0062)	363, 371
(3008,0064)	351, 354, 365, 369
(3008,0066)	363, 371
(3008,0070)	352, 355, 366, 369
(3008,0072)	352, 355, 366, 369
(3008,0074)	352
(3008,0076)	352, 355, 366, 369
(3008,0078)	354
(3008,007A)	354
(3008,0080)	354, 365, 366, 368, 369
(3008,0082)	354, 365, 368, 369
(3008,0090)	354, 355, 366, 369
(3008,0092)	355, 366, 369
(3008,00A0)	355, 360
(3008,00B0)	356
(3008,00C0)	356
(3008,00D0)	357
(3008,00E0)	373
(3008,0100)	364, 370
(3008,0105)	364
(3008,010C)	349
(3008,0110)	364
(3008,0116)	365
(3008,0120)	367
(3008,0122)	367
(3008,0130)	367, 370, 371
(3008,0132)	368
(3008,0134)	368
(3008,0136)	368
(3008,0138)	368, 372
(3008,013A)	368
(3008,013C)	368
(3008,0140)	369, 370
(3008,0142)	369
(3008,0150)	370
(3008,0152)	370
(3008,0160)	371
(3008,0162)	370
(3008,0164)	371
(3008,0166)	371
(3008,0168)	371
(3008,0200)	372, 374
(3008,0202)	372
(3008,0220)	372
(3008,0223)	372

(3008,0224)	372
(3008,0230)	361
(3008,0240)	372, 373
(3008,0250)	350, 372, 609
(3008,0251)	350, 373, 609
(3008,0286)	347
(300A, 0010)	352, 355
(300A, 0012)	352, 355
(300A, 00C2)	336
(300A, 0180)	355
(300A, 0182)	355
(300A,0002)	311, 608
(300A,0003)	311
(300A,0004)	298, 311, 337
(300A,0006)	311, 608
(300A,0007)	311, 608
(300A,0009)	311
(300A,000A)	311
(300A,000B)	311
(300A,000C)	312, 313
(300A,000E)	313
(300A,0010)	313, 314, 320, 333, 346, 351, 354, 365, 366, 368, 369, 373
(300A,0012)	313, 320, 333, 351, 354, 365, 366, 368, 369, 373
(300A,0014)	313, 314, 315, 320, 321
(300A,0015)	359
(300A,0016)	314, 373
(300A,0018)	313, 314, 338
(300A,001A)	314
(300A,0020)	314, 315, 320, 321
(300A,0021)	314, 320
(300A,0022)	314, 320
(300A,0023)	314, 320
(300A,0025)	314, 320
(300A,0026)	314, 320
(300A,0027)	314, 320
(300A,0028)	315, 320
(300A,002A)	315, 320
(300A,002B)	315, 321
(300A,002C)	315, 321
(300A,002D)	315, 321
(300A,0040)	315, 316
(300A,0042)	315, 325, 326, 327
(300A,0043)	315
(300A,0044)	315
(300A,0046)	315
(300A,0048)	316
(300A,004A)	316
(300A,004C)	316
(300A,004E)	316
(300A,0051)	316
(300A,0052)	316
(300A,0053)	316
(300A,0055)	313, 323
(300A,0070)	319, 372

(300A.0071)	298, 319, 372
(300A.0078)	321, 353, 363, 372
(300A.0079)	321
(300A.007A)	321
(300A.007B)	321
(300A.0080)	55, 321
(300A.0082)	322, 323
(300A.0084)	322, 339
(300A.0086)	322, 323, 337
(300A.00A0)	55, 321, 322
(300A.00A2)	322, 323
(300A.00A4)	322, 349
(300A.00B0)	321, 323, 330, 353
(300A.00B2)	324, 340, 351
(300A.00B3)	290, 291, 322, 325, 326, 337, 353
(300A.00B4)	325, 355
(300A.00B6)	292, 325, 326, 334
(300A.00B8)	292, 316, 325, 326, 334, 355, 360
(300A.00BA)	292, 325
(300A.00BC)	292, 325, 326, 334, 355, 360
(300A.00BE)	292, 326, 337
(300A.00C0)	290, 298, 321, 323, 336, 353
(300A.00C2)	323, 353
(300A.00C3)	323, 336, 353
(300A.00C4)	324, 337, 353
(300A.00C6)	324, 353, 359
(300A.00C7)	324
(300A.00C8)	326, 327
(300A.00CA)	326, 337
(300A.00CC)	327
(300A.00CE)	327, 358, 366
(300A.00D0)	328, 356
(300A.00D1)	328, 333
(300A.00D2)	328, 333, 356, 359
(300A.00D3)	328, 356
(300A.00D4)	328, 356
(300A.00D5)	328, 356
(300A.00D6)	328
(300A.00D8)	328, 356
(300A.00DA)	328
(300A.00E0)	328, 329, 356
(300A.00E1)	294, 311, 329, 330, 331, 341, 343, 344, 345, 347
(300A.00E2)	329
(300A.00E3)	329, 330
(300A.00E4)	329, 356
(300A.00E5)	329, 356
(300A.00E6)	329
(300A.00E7)	329
(300A.00E8)	329
(300A.00E9)	329
(300A.00EA)	329
(300A.00EB)	330
(300A.00EC)	330
(300A.00ED)	330, 356

(300A,00EE)	356
(300A,00F0)	293, 330, 331, 357
(300A,00F4)	293, 294, 331, 332
(300A,00F5)	293, 331, 357
(300A,00F6)	293, 331
(300A,00F8)	293, 331, 338
(300A,00FA)	294, 331
(300A,00FC)	294, 331, 357
(300A,00FE)	294, 331, 357
(300A,0100)	294, 331, 338
(300A,0102)	331, 338
(300A,0104)	294, 331, 332
(300A,0106)	294, 332
(300A,0107)	293, 332, 357
(300A,0108)	293, 332, 357
(300A,0109)	293, 332, 357
(300A,010A)	293, 332, 358
(300A,010C)	333, 339, 346, 349
(300A,010E)	323, 332, 337
(300A,0110)	332, 346, 358, 371
(300A,0111)	324, 328, 329, 330, 331, 332, 333
(300A,0112)	332, 346, 359
(300A,0114)	328, 329, 330, 331, 333, 338, 359
(300A,0115)	333, 359
(300A,0116)	333, 334, 359
(300A,0118)	333, 359
(300A,011A)	334, 360
(300A,011B4)	318
(300A,011C)	292, 334, 337, 360
(300A,011E)	49, 294, 334, 339, 360
(300A,011F)	335, 338, 361
(300A,0120)	294, 335, 339, 361
(300A,0121)	335, 338, 361
(300A,0122)	294, 335, 339, 361
(300A,0123)	335, 338, 362
(300A,0124)	294, 335, 362
(300A,0125)	295, 336, 339, 362
(300A,0126)	336, 338, 362
(300A,0128)	295, 336, 339, 362
(300A,0129)	295, 336, 339, 362
(300A,012A)	295, 336, 339, 363
(300A,012C)	336
(300A,012E)	336
(300A,0130)	336
(300A,0134)	323, 324, 332, 333, 337, 338
(300A,0180)	317, 319
(300A,0182)	317, 319, 326
(300A,0184)	317
(300A,0190)	317
(300A,0192)	317
(300A,0194)	317
(300A,0196)	317
(300A,0198)	317
(300A,01A0)	317, 318

(300A,01A2)	318
(300A,01A4)	318
(300A,01A6)	318
(300A,01A8)	318
(300A,01B0)	318
(300A,01B2)	318
(300A,01B4)	318
(300A,01B6)	318
(300A,01B8)	318
(300A,01BA)	318
(300A,01BC)	318
(300A,01D0)	319
(300A,01D2)	319
(300A,01D4)	319
(300A,01D6)	319
(300A,0200)	340, 363
(300A,0202)	340, 344, 347, 349, 364, 368, 370, 371, 372
(300A,0206)	340, 351
(300A,0210)	341, 346
(300A,0212)	341, 364
(300A,0214)	341, 364
(300A,0216)	341, 364
(300A,0218)	341
(300A,021A)	341
(300A,0222)	341
(300A,0224)	341
(300A,0226)	341, 364
(300A,0228)	341, 364
(300A,022A)	341, 344, 364
(300A,022C)	341, 364
(300A,022E)	341, 364
(300A,0230)	299, 322, 341, 364
(300A,0232)	342, 364
(300A,0234)	299, 322, 342, 364
(300A,0236)	342, 364
(300A,0238)	342, 365
(300A,0240)	342, 365
(300A,0242)	342, 365
(300A,0244)	342, 365
(300A,0250)	342, 365
(300A,0260)	342, 343
(300A,0262)	343, 367
(300A,0263)	343, 367
(300A,0264)	343, 367
(300A,0266)	343, 367
(300A,026A)	343
(300A,026C)	343
(300A,0280)	343
(300A,0282)	343, 368
(300A,0284)	343, 347, 368
(300A,0286)	344, 347, 349
(300A,0288)	344, 345, 347, 348, 368, 370
(300A,028A)	344, 349
(300A,028C)	344

(300A,0290)	344, 345, 369
(300A,0291)	344, 369
(300A,0292)	344, 370
(300A,0294)	344, 370
(300A,0296)	344, 347, 370
(300A,0298)	344, 370
(300A,029C)	344
(300A,029E)	344
(300A,02A0)	345, 370
(300A,02A2)	345, 370
(300A,02A4)	345, 347, 370
(300A,02B0)	345
(300A,02B2)	345, 370
(300A,02B3)	345, 370
(300A,02B4)	345, 370
(300A,02B8)	345
(300A,02BA)	345
(300A,02C8)	346, 347
(300A,02D0)	344, 346, 347, 348, 368, 372
(300A,02D2)	346, 347, 349, 371
(300A,02D4)	346, 349
(300A,02D6)	346, 347, 349
(300C, 0051)	354
(300C,0002)	290, 291, 298, 299, 301, 312, 313, 350, 357, 373
(300C,0004)	298, 321
(300C,0006)	290, 291, 298, 321, 353, 356, 357, 359
(300C,0007)	327
(300C,0008)	291, 326, 337
(300C,0009)	291, 326, 327, 337
(300C,000A)	299, 322
(300C,000C)	299, 322, 364
(300C,000E)	344, 346, 370
(300C,0020)	298
(300C,0022)	291, 298, 353, 363, 372
(300C,0040)	353, 354, 365, 372
(300C,0042)	326, 342
(300C,0050)	320, 323, 333
(300C,0051)	320, 333, 346, 351, 352, 354, 355, 365, 366, 368, 369, 373
(300C,0055)	346
(300C,0060)	300, 302, 312, 313, 314, 330, 343, 345
(300C,006A)	319, 326, 355
(300C,0080)	312, 313, 319, 320, 322, 327, 328
(300C,00A0)	325
(300C,00B0)	330, 357
(300C,00C0)	333, 359
(300C,00D0)	356
(300C,00E0)	357
(300C,00F0)	359, 371
(300E,0002)	349, 350
(300E,0004)	350
(300E,0005)	350
(300E,0008)	350
(4008,0040)	144, 604
(4008,0042)	144

(4008,0050)	143
(4008,0100)	145
(4008,0101)	145
(4008,0102)	145
(4008,0103)	145
(4008,0108)	146, 605
(4008,0109)	146
(4008,010A)	146
(4008,010B)	146
(4008,010C)	146, 605
(4008,0111)	146
(4008,0112)	146
(4008,0113)	146
(4008,0114)	146
(4008,0115)	146, 605
(4008,0117)	146, 605
(4008,0118)	146
(4008,0119)	146
(4008,011A)	146
(4008,0200)	145, 605
(4008,0202)	145
(4008,0210)	145, 605
(4008,0212)	145, 605
(4008,0300)	144
(4008,4000)	144
(4FFE,0001)	502, 504
(50xx, 0112)	269
(50xx,0005)	49, 392, 393, 450
(50xx,0010)	49, 450, 452
(50xx,0020)	49, 392, 393, 394, 450, 451
(50xx,0022)	49, 450
(50xx,0030)	392, 393, 394, 450, 451
(50xx,0040)	450
(50xx,0103)	49, 450, 451, 452
(50xx,0104)	450
(50xx,0105)	450
(50xx,0106)	450
(50xx,0110)	450, 452
(50xx,0112)	450, 452
(50xx,0114)	450, 452
(50xx,1001)	490
(50xx,2000)	453
(50xx,2002)	453
(50xx,2004)	453
(50xx,2006)	453
(50xx,2008)	453
(50xx,200A)	453, 454
(50xx,200C)	453
(50xx,200E)	454
(50xx,2500)	451
(50xx,2600)	451
(50xx,2610)	451
(50xx,3000)	49, 392, 393, 394, 450, 451, 452, 453
(5400, 0002)	157

(5400,0100)	81, 82, 84, 85, 86, 88, 468, 476, 561
(5400,0110)	470
(5400,0112)	470, 624
(5400,1004)	470, 473, 625
(5400,1006)	81, 83, 84, 85, 87, 89, 471, 473, 474, 625
(5400,100A)	471, 625
(5400,1010)	471, 472
(6000,0010)	447, 536
(6000,0011)	447, 448, 536
(6000,0050)	447, 536
(6000,0100)	447, 536
(6000,0102)	447, 536
(6000,3000)	447, 536
(60xx,0010)	192, 444
(60xx,0011)	192, 444
(60xx,0015)	446, 447
(60xx,0022)	445
(60xx,0040)	192, 444
(60xx,0045)	254, 445
(60xx,0050)	192, 445
(60xx,0051)	446, 447
(60xx,0100)	192, 445
(60xx,0102)	192, 445, 490
(60xx,1001)	490
(60xx,1301)	446
(60xx,1302)	446
(60xx,1303)	446
(60xx,1500)	445
(60xx,3000)	192, 444, 445
(7FE0,0010)	49, 166, 170, 213, 261, 296, 297, 299, 380, 396, 397, 405, 408, 409, 412, 413, 414, 444, 445, 486, 490, 517
(FFFA,FFFA)	502
(FFFC,FFFC)	504
(FFFE,E000)	505
(FFFE,E00D)	504
(FFFE,E0DD)	505, 506